

A SERVICE-ORIENTED TECHNICAL FRAMEWORK FOR THE DEVELOPMENT OF  
INTEGRATED EDUCATION MANAGEMENT INFORMATION SYSTEM

by

Ademola Olaide Adenubi

submitted in accordance with the requirements  
for the degree of

Doctor of Philosophy

in the subject

Computer Science

at the

UNIVERSITY OF SOUTH AFRICA

SUPERVISOR: DR J.S MTSWENI

September 2021

## ABSTRACT

The increasing demand for education, especially tertiary education, has triggered a lot of challenges within the university system, especially in developing nations like Nigeria. These challenges include management and administration of the following: students' enrolment, staff and students profile information, tuition fees payment, course registration, examination, and result processing, among others. The development of various types of Education Management Information Systems (EMIS) to alleviate these challenges has presented a more efficient means of optimising processes in the university systems. Thus, stakeholders within the university system: administrators, lecturers and students interact with the EMIS to ease their respective academic activities.

However, these EMIS are designed, developed, and deployed with different application platforms and programming standards, which make it difficult for different EMIS to share information as they act as isolated information island. Thus, there is a challenge of data exchange in integrating different EMIS to achieve cross platform data exchange. Meanwhile, there are such initiatives on standard frameworks for the integration of disparate systems that are found in education institutions like the Education Management Information System Interoperability Framework (EMIF) and the School Interoperability Framework (SIF). However, the complexity in the mechanism for data exchange of these frameworks and the limited focus on the design structure of EMIS that can easily adapt and integrate limit their use in education institutions, especially those in developing countries with limited technical manpower and knowhow.

In the search for a simplified framework that reconsider EMIS as an integrated system that can seamlessly exchange data, this research study involved the investigation, design, demonstration, and evaluation of a service-oriented technical framework for the development of integrated EMIS using the design science research methodology. This study, therefore, contributed to knowledge with the proposition of a technical framework that simplifies and standardizes the development of integrated EMIS that seamlessly exchange data among different functional modules. The technical framework is designed based on the identified layered conceptual components: **a)** Education Information Structure (EIS) that provides adaptable Central Information System (CIS) for handling the specific information requirements of different education systems with Access Control that provides a layer of security services to check and grant authorization and authentication access; **b)** Service-Oriented Design layer that

handles integration of functional modules to connect with the EIS with service interfaces using Representational State Transfer Application Programming Interface (REST API); **c)** Demonstration Logic layer that recognizes the development platform and the flexibility of the programming logic to scale with new information requirements; **d)** Data Exchange Mechanism that provides a layer of standard data serialization format using Java Script Object Notation (JSON) to exchange data, through the RESTful API services, among functional modules in the Service-Oriented Design layer and the CIS in the EIS layer; **e)** Database System layer that handles data storage and requests from services.

Thus, the framework makes key contributions with provision for customisation and multi-tenant cloud approach for adaptability and standardisation of the development of integrated EMIS to fit into different education systems. It was demonstrated on a web-based platform using the Laravel development platform that offer framework for rapid application development. The demonstration considered a case study approach, and the evaluation was based on expert reviews and comparative analysis within the context of the key requirements from the research findings. These requirements are: **a)** Adaptability that consider the suitability to fit into the specific information requirement of the different education systems; **b)** Maintainability that underscore the use of simplified common technologies that can be delivered within the knowledge of the EMIS developer; **c)** Standardization that check for the use of standard technologies and techniques; **d)** Scalability that consider provision for extension of the CIS and the functional modules to respond to changes in information requirements of the education system; **e)** Connectivity that benchmark access to shared data sources by the different functional modules of the integrated EMIS; **f)** Accessibility that benchmark usability of the platform to deliver user expectations on cross-platform data for presentation.

In essence, the technical framework is appropriate for the development of an integrated EMIS that uses simplified technologies and techniques for achieving EMIS integration. While the framework addressed the integrated EMIS development that achieve seamless data exchange and scalability using the service endpoint extensions, the issues of optimizing the framework for enhanced security and performance are open to further research.

**Keywords:** Service-Oriented Technical Framework, Education Management Information System, Integrated EMIS Development, EMIS Functional Modules, Education Information

Structure, Service-Oriented Design, Data Exchange Mechanism, EMIS Demonstration Logic, Database System, Framework Evaluation Requirements.

## DECLARATION

Name: \_\_\_\_\_ADEMOLA OLAIDE ADENUBI\_\_\_\_\_

Student Number: \_\_\_\_\_49131036\_\_\_\_\_

Degree: \_\_\_\_\_DOCTOR OF PHILOSOPHY\_\_\_\_\_

Title:

A SERVICE-ORIENTED TECHNICAL FRAMEWORK FOR THE DEVELOPMENT OF  
INTEGRATED EDUCATION MANAGEMENT INFORMATION SYSTEM

---

I declare that the above thesis is my own work and that all the sources that I have used or quoted have been indicated and acknowledged by means of complete references.

I further declare that I submitted the thesis to originality checking software and that it falls within the accepted requirements for originality.

I further declare that I have not previously submitted this work, or part of it, for examination at Unisa for another qualification or at any other higher education institution.

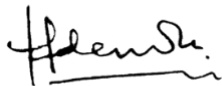

\_\_\_\_\_  
SIGNATURE

15 June 2021

\_\_\_\_\_  
DATE

## DEDICATION

I dedicate this doctoral thesis to my lovely wife (Mariam) and our four children (Habeeblah, Ridwanlah, Nasirlah, and Nimotlah) for their unconditional breadth of support and depth of understanding in the course of this study. Also, to the committed team members of the EDUTAMS project.

## **ACKNOWLEDGEMENT**

I thank the Almighty God for the precious gift of life and I acknowledge His blessings of abundant knowledge to pursue this research study.

My gratitude to my family, especially my wife and our children, for their continuous support, patience, understanding and motivations to pursue and complete this study.

I also acknowledge the opportunity given by the Tai Solarin University of Education, Nigeria, and the Tertiary Education Trust Fund (TETFUND) of the Federal Republic of Nigeria to pursue this doctoral study.

I greatly acknowledge the tremendous contributions, understanding and support of my supervisor, Dr Jabu Mtsweni, in providing a great latitude of guidance and direction for this thesis through regular discussions, comments and feedbacks.

To all others, who have given salient supports and challenges leading to the success and completion of this thesis, I graciously thank and acknowledge you.

God's blessing!

# Table of Contents

<b>ABSTRACT.....</b>	<b>II</b>
<b>DEDICATION.....</b>	<b>VI</b>
<b>ACKNOWLEDGEMENT.....</b>	<b>VII</b>
<b>DEFINITION OF TERMS.....</b>	<b>XIV</b>
<b>CHAPTER 1 : INTRODUCTION.....</b>	<b>1</b>
1.1 BACKGROUND OF THE STUDY .....	2
1.2 PROBLEM STATEMENT.....	4
1.3 THE PURPOSE OF THE STUDY.....	5
1.4 RESEARCH QUESTIONS.....	5
1.5 RESEARCH OBJECTIVES.....	6
1.6 SIGNIFICANCE OF THE STUDY.....	6
1.7 RESEARCH DESIGN AND METHODOLOGY .....	7
1.7.1 <i>Research Design and Approach</i> .....	9
1.7.2 <i>Conceptual Research Design</i> .....	11
1.7.3 <i>Sample Population and Design</i> .....	12
1.7.4 <i>Case Study Approach</i> .....	12
1.7.5 <i>Data Collection Methods</i> .....	13
1.7.6 <i>Data Analysis Technique</i> .....	15
1.7.7 <i>Data Quality Control</i> .....	16
1.8 ETHICAL CONSIDERATIONS .....	17
1.9 SCOPE AND LIMITATIONS .....	17
1.10 RELATED WORK .....	18
1.11 STRUCTURE OF THE THESIS .....	19
1.12 CLOSING REMARK .....	21
<b>CHAPTER 2 : EDUCATION MANAGEMENT INFORMATION SYSTEM .....</b>	<b>23</b>
2.1 OPENING REMARK.....	24
2.2 EMIS IN TERTIARY EDUCATION SYSTEM.....	25
2.3 FORMS OF EMIS IN TERTIARY EDUCATION INSTITUTIONS.....	27
2.4 EMIS IN NIGERIA TERTIARY EDUCATION SYSTEM .....	29
2.5 DESIGN CONSIDERATIONS FOR EMIS DEVELOPMENT.....	30
2.5.1 <i>Data Representations</i> .....	31
2.5.2 <i>Data Exchange Mechanism</i> .....	34
2.5.3 <i>Serialisation Formats and Standards</i> .....	35
2.5.4 <i>Design Architectures</i> .....	38
2.5.5 <i>Development Platforms</i> .....	40
2.6 BENEFITS AND LIMITATIONS OF EMIS .....	41
2.6.1 <i>Advantages and Benefits of EMIS</i> .....	42
2.6.2 <i>Challenges and Limitations of EMIS</i> .....	43
2.7 CLOSING REMARK.....	44
<b>CHAPTER 3 : EMIS INTEGRATION .....</b>	<b>45</b>
3.1 OPENING REMARK.....	46
3.2 CONSIDERATIONS FOR EMIS INTEGRATION .....	47
3.2.1 <i>The Focus of Integration</i> .....	47
3.2.2 <i>The Purpose of Integration</i> .....	48
3.2.3 <i>The Level of Integration</i> .....	49
3.3 DESIGN APPROACHES TO EMIS INTEGRATION.....	51
3.3.1 <i>Enterprise Application Integration (EAI)</i> .....	52
3.3.2 <i>Service-Oriented Architecture (SOA)</i> .....	54
3.4 STANDARD TECHNOLOGIES FOR EMIS INTEGRATION .....	57
3.4.1 <i>Web Services</i> .....	57



3.4.2	<i>Semantic Web Services</i> .....	59
3.4.3	<i>Web Services API</i> .....	60
3.5	SELECTED FRAMEWORKS FOR EMIS INTEGRATION.....	62
3.5.1	<i>School Interoperability Framework (SIF)</i> .....	65
3.5.2	<i>Education Management Information Interoperability Framework (EMIF)</i> .....	67
3.6	BENEFITS AND LIMITATIONS OF EMIF AND SIF FRAMEWORKS.....	71
3.7	CASE STUDIES OF EMIS INTEGRATION.....	72
3.7.1	<i>SOA with Web Services</i> .....	72
3.7.2	<i>SOA with Web Services Using Agent Systems</i> .....	73
3.7.3	<i>SOA with Web Services Using Middleware Platform</i> .....	74
3.7.4	<i>EAI with Middleware Infrastructure</i> .....	75
3.7.5	<i>RESTful API Interoperability Model</i> .....	76
3.8	CLOSING REMARK.....	78
<b>CHAPTER 4 : QUALITATIVE INTERVIEW FINDINGS AND DISCUSSIONS.....</b>		<b>80</b>
4.1	OPENING REMARK.....	81
4.2	PROCEDURE AND DESCRIPTION OF THE INTERVIEW PROCESS.....	82
4.2.1	<i>Interview Procedure</i> .....	82
4.2.2	<i>Profile of the Respondents</i> .....	83
4.2.3	<i>Description of the Interview Questions</i> .....	85
4.3	ANALYSIS OF FINDINGS.....	86
4.4	SIGNIFICANCE OF EMIS.....	88
4.4.1	<i>Purpose and Usage</i> .....	88
4.4.2	<i>Functions and Benefits</i> .....	89
4.5	STRUCTURE AND ARCHITECTURE OF EMIS.....	90
4.5.1	<i>Structure of EMIS in Nigerian Universities</i> .....	90
4.5.2	<i>Challenges with EMIS Design Structure</i> .....	91
4.6	PROCESS OF EMIS DEVELOPMENT.....	91
4.6.1	<i>Plans and Procedures for Development</i> .....	92
4.6.2	<i>Approaches to Development Process</i> .....	93
4.6.3	<i>Considerations for Development</i> .....	94
4.6.4	<i>Modes and Approaches to Development</i> .....	95
4.6.5	<i>Implications of Development Approach</i> .....	96
4.7	DATA PROCESSING AND EXCHANGE IN EMIS.....	96
4.7.1	<i>Forms and Structure of Data</i> .....	97
4.7.2	<i>Data Processing and Control</i> .....	97
4.7.3	<i>Database Connections</i> .....	98
4.7.4	<i>Data Exchange Approaches</i> .....	99
4.8	PLATFORM FOR EMIS DEVELOPMENT.....	100
4.8.1	<i>Development Platforms</i> .....	100
4.8.2	<i>Benefits and Limitations</i> .....	101
4.9	APPROACHES TO EMIS INTEGRATION.....	102
4.9.1	<i>Achieving EMIS Integration</i> .....	102
4.9.2	<i>EMIS Integration Challenges</i> .....	103
4.9.3	<i>Benefits and Limitations</i> .....	104
4.10	DESIGN STANDARDS FOR INTEGRATED EMIS DEVELOPMENT.....	105
4.10.1	<i>Awareness on Standard Design Framework</i> .....	105
4.10.2	<i>Between Practice and Standard Framework</i> .....	106
4.10.3	<i>Challenges and Limitations</i> .....	107
4.11	CLOSING REMARK.....	109
<b>CHAPTER 5 : EMIS DESIGN PRINCIPLES AND REQUIREMENTS.....</b>		<b>111</b>
5.1	OPENING REMARK.....	112
5.2	PROCEDURE AND APPROACH TO INDUCTIVE REASONING.....	112
5.3	THEMATIC ISSUES FROM THE ANALYSIS OF RESEARCH FINDINGS.....	113
5.3.1	<i>Development Process</i> .....	114
5.3.2	<i>Design Structure</i> .....	114

5.3.3	<i>Design Standard</i> .....	115
5.3.4	<i>Data Exchange</i> .....	115
5.3.5	<i>Development Platform</i> .....	116
5.3.6	<i>Integration Approach</i> .....	116
5.3.7	<i>Significant Value</i> .....	117
5.4	DESIGN PRINCIPLES FOR INTEGRATED EMIS DEVELOPMENT FRAMEWORK .....	117
5.4.1	<i>Principle 1: Identify the Information Needs of the Education Institution</i> .....	118
5.4.2	<i>Principle 2: Set-up and Organise the EMIS Development Team</i> .....	119
5.4.3	<i>Principle 3: Enhance the Technical Know-how of the EMIS Developers</i> .....	121
5.4.4	<i>Principle 4: Chose the Design Architecture for EMIS Implementation</i> .....	122
5.4.5	<i>Principle 5: Adopt a Design Standard</i> .....	124
5.4.6	<i>Principle 6: Choose the Standard Data Format for Information Exchange</i> .....	125
5.4.7	<i>Principle 7: Ensure EMIS Gain Access to Shared Database</i> .....	126
5.4.8	<i>Principle 8: Adopt a Standard Programming Logic for EMIS Development</i> .....	127
5.4.9	<i>Principle 9: Define Endpoints and Re-Usable Methods for Data Exchange</i> .....	128
5.4.10	<i>Principle 10: Make Provision for New Information Needs and Plugins</i> .....	129
5.4.11	<i>Principle 11: Collect and Store Data from Multiple Data Sources</i> .....	130
5.4.12	<i>Principle 12: Present Data in Format that Support Decision-Making</i> .....	131
5.5	REQUIREMENTS FOR INTEGRATED EMIS DEVELOPMENT FRAMEWORK .....	132
5.5.1	<i>Adaptability</i> .....	134
5.5.2	<i>Maintainability</i> .....	134
5.5.3	<i>Standardisation</i> .....	135
5.5.4	<i>Scalability</i> .....	135
5.5.5	<i>Connectivity</i> .....	135
5.5.6	<i>Accessibility</i> .....	136
5.6	CLOSING REMARK .....	136
<b>CHAPTER 6 : PROPOSED TECHNICAL FRAMEWORK.....</b>		<b>138</b>
6.1	OPENING REMARK.....	139
6.2	RECAP ON EMIS CHALLENGES AND LIMITATIONS .....	140
6.2.1	<i>Connecting Challenges from Literatures and Findings</i> .....	141
6.2.2	<i>Solution Approaches</i> .....	142
6.2.3	<i>Solution Requirements</i> .....	143
6.3	PROCEDURE FOR THE SOLUTION FRAMEWORK.....	143
6.4	FRAMEWORK DESIGN ABSTRACTION .....	145
6.5	PROPOSED SERVICE-ORIENTED TECHNICAL FRAMEWORK.....	148
6.5.1	<i>Education Information Structure</i> .....	150
6.5.2	<i>Service-Oriented Design</i> .....	151
6.5.3	<i>Demonstration Logic</i> .....	153
6.5.4	<i>Data Exchange Mechanism</i> .....	154
6.5.5	<i>Database System</i> .....	155
6.6	CLOSING REMARK.....	156
<b>CHAPTER 7 : FRAMEWORK DEMONSTRATION WITH A CASE STUDY .....</b>		<b>159</b>
7.1	OPENING REMARK.....	160
7.2	CONTEXTUALISING CASE STUDY DEMONSTRATION .....	160
7.2.1	<i>Justifications for the Case Study Environment</i> .....	161
7.2.2	<i>Demonstration Approach and Procedure</i> .....	162
7.2.3	<i>Development Platform</i> .....	164
7.3	SOLUTION CONCEPT FOR THE CASE STUDY.....	165
7.4	CASE STUDY DEMONSTRATION OF THE PROPOSED FRAMEWORK .....	167
7.4.1	<i>Education Information Structure</i> .....	168
7.4.2	<i>Service-Oriented Design</i> .....	170
7.4.3	<i>Demonstration Logic</i> .....	174
7.4.4	<i>Exchange Mechanism</i> .....	182
7.4.5	<i>Database System</i> .....	184
7.5	CLOSING REMARK .....	187

<b>CHAPTER 8 : EVALUATION OF PROPOSED TECHNICAL FRAMEWORK .....</b>	<b>190</b>
8.1 OPENING REMARK.....	191
8.2 EVALUATION APPROACH AND PROCEDURE.....	192
8.3 EXPERT REVIEW .....	192
8.3.1 <i>Approach and Procedure</i> .....	193
8.3.2 <i>Analysis and Interpretations</i> .....	194
8.4 COMPARATIVE ANALYSIS.....	200
8.4.1 <i>Approach and Procedure</i> .....	200
8.4.2 <i>Comparative Criteria</i> .....	201
8.4.3 <i>Comparison and Discussions</i> .....	204
8.5 CLOSING REMARK.....	206
<b>CHAPTER 9 : SUMMARY, CONCLUSION AND FUTURE WORK .....</b>	<b>208</b>
9.1 OPENING REMARK.....	209
9.2 RESEARCH QUESTIONS AND OBJECTIVES .....	209
9.3 RESEARCH CONTRIBUTIONS.....	214
9.4 SCOPE AND LIMITATION OF PROPOSED FRAMEWORK.....	214
9.5 CONCLUSION .....	215
9.6 FUTURE RESEARCH .....	216
<b>REFERENCES .....</b>	<b>218</b>
<b>APPENDIX 1.....</b>	<b>231</b>
<b>APPENDIX 2.....</b>	<b>233</b>
<b>APPENDIX 3.....</b>	<b>235</b>
<b>APPENDIX 4.....</b>	<b>250</b>
<b>APPENDIX 5.....</b>	<b>252</b>
<b>LANGUAGE EDITING CERTIFICATE .....</b>	<b>255</b>
<b>THESIS SUMMARY.....</b>	<b>256</b>

## LIST OF FIGURES

FIGURE 1.1: OBJECTIVE OVERVIEW OF CHAPTER ONE.....	1
FIGURE 1.2: DESIGN APPROACH OF EMIS AS UNIFIED INFORMATION SYSTEM .....	3
FIGURE 1.3: DESIGN APPROACH OF EMIS AS SUITE OF ENTERPRISE APPLICATIONS .....	3
FIGURE 1.4: CONCEPTUAL STUDY FRAMEWORK FOR RESEARCH DESIGN AND METHODOLOGY.....	11
FIGURE 1.5: STRUCTURE OF THE THESIS COMBINING CHAPTERS AND STAGES IN DSRM .....	21
FIGURE 2.1: OBJECTIVE OVERVIEW OF CHAPTER TWO .....	23
FIGURE 2.2: EMIS AS A SUPPORT SYSTEM .....	24
FIGURE 2.3: INFORMATION FLOW ACROSS LEVELS IN TERTIARY EMIS ADAPTED FROM (VILLANUEVA, 2003).....	26
FIGURE 2.4: DESIGN CONSIDERATIONS FOR EMIS DEVELOPMENT .....	31
FIGURE 2.5: DATA EXCHANGE MECHANISM SOURCE: (MIKREYJOHANNES & OMER, 2013).....	34
FIGURE 2.6: 2-TIER ARCHITECTURE.....	38
FIGURE 2.7: 3-TIER ARCHITECTURE.....	39
FIGURE 2.8: POTENTIAL OF INTEGRATED EMIS .....	41
FIGURE 3.1: OBJECTIVE OVERVIEW OF CHAPTER THREE .....	45
FIGURE 3.2: THE 3 KEY PURPOSES OF EMIS INTEGRATION.....	48
FIGURE 3.3: DIRECT POINT-TO-POINT EAI ARCHITECTURE .....	53
FIGURE 3.4: MIDDLEWARE BASED EAI ARCHITECTURE.....	53
FIGURE 3.5: WEB SERVICE COMPONENTS, OPERATIONS AND PROTOCOLS INTERACTIONS .....	57
FIGURE 3.6: WEB API ARCHITECTURE .....	61
FIGURE 3.7: ARCHITECTURE OF THE SIF (ADAPTED FROM JAKIMOSKI (2016)) .....	67
FIGURE 3.8: STRUCTURE AND ARCHITECTURE OF EMIF SOURCE: WANG YANFENG, (2009) .....	68
FIGURE 3.9: ZIS MECHANISM FOR MESSAGE PROCESSING AND EXCHANGE SOURCE: WANG YANFENG (2009) .....	69
FIGURE 3.10: AGENT MECHANISM FOR MESSAGE PROCESSING AND EXCHANGE SOURCE: DONGDAI <i>ET AL</i> (2010).....	70
FIGURE 3.11: MULTI-TIER EMIS INTEGRATION FRAMEWORK SOURCE: YUNYUN & HUAKUN (2010).....	72
FIGURE 3.12: SOA WITH WS FOR INTEGRATION USING THE ZIS. SOURCE: DONGDAI, ET AL. (2010) .....	73
FIGURE 3.13: SOA WITH WS FOR INTEGRATION USING SYSTEM I3 SOURCE: CHANDIO, ZHU, & SODHRO, (2012).....	74
FIGURE 3.14: HIGHER EDUCATION EAI SOURCE: ASEREY & ALSHAWI (2013) .....	75
FIGURE 3.15: RESTFUL API INTEROPERABILITY MODEL. SOURCE: BAHAA, SAYED, & ELFANGARY (2018) .....	76
FIGURE 4.1: OBJECTIVE OVERVIEW OF CHAPTER FOUR .....	80
FIGURE 5.1: OBJECTIVE OVERVIEW OF CHAPTER FIVE .....	111
FIGURE 5.2: THEMATIC ISSUES AND DESIGN PRINCIPLES FOR INTEGRATED EMIS DEVELOPMENT .....	118
FIGURE 6.1: OBJECTIVE OVERVIEW OF CHAPTER SIX.....	138
FIGURE 6.2: PROCESS FLOW FOR THE PROPOSED FRAMEWORK DESIGN.....	140
FIGURE 6.3: CONCEPTUAL FRAMEWORK FOR INTEGRATED EMIS DEVELOPMENT.....	147
FIGURE 6.4: CONNECTING THE CONCEPTUAL FRAMEWORK TO THE PROPOSED FRAMEWORK .....	149
FIGURE 6.5: INTEGRATED EMIS DEVELOPMENT FRAMEWORK .....	149
FIGURE 7.1: OBJECTIVE OVERVIEW OF CHAPTER SEVEN .....	159
FIGURE 7.2: EXISTING EMIS STRUCTURE OF THE CASE STUDY ENVIRONMENT.....	161
FIGURE 7.3: CONCEPTUAL DESIGN OF CASE STUDY DEMONSTRATION .....	166
FIGURE 7.4: CASE STUDY IMPLEMENTATION OF EIS IN TERTIARY EDUCATION INSTITUTION.....	169
FIGURE 7.5: EDUCATION INFORMATION STRUCTURE IMPLEMENTATION .....	172
FIGURE 7.6: CASE STUDY DEMONSTRATION OF FUNCTIONAL MODULES IN INTEGRATED EMIS .....	173
FIGURE 7.7: DEVELOPMENT LOGIC DEMONSTRATION.....	175
FIGURE 7.8: PROGRAMMING LOGIC FOR RESTFUL API IMPLEMENTATION .....	175
FIGURE 7.9: PROGRAMMING LOGIC FOR MIDDLEWARE IMPLEMENTATION .....	176
FIGURE 7.10: PROGRAMMING LOGIC FOR EVENT AND LISTENER DEMONSTRATION .....	177
FIGURE 7.11: CASE STUDY DEMONSTRATION OF USER AUTHENTICATION .....	178
FIGURE 7.12: PROGRAMMING LOGIC FOR AUTHENTICATION AND AUTHORISATION INTO THE INTEGRATED EMIS .....	179
FIGURE 7.13: PROGRAMMING LOGIC FOR AUTHORISATION WITH ASSIGNMENT OF ROLES AND PERMISSIONS.....	180
FIGURE 7.14: CASE STUDY DEMONSTRATION OF USER AUTHORISATION .....	180
FIGURE 7.15: PROGRAMMING LOGIC FOR INTEGRATING RESTFUL SERVICES OF FUNCTIONAL MODULES OF INTEGRATED EMIS .....	181
FIGURE 7.16: PROGRAMMING LOGIC FOR RESTFUL API REGISTRY .....	182

FIGURE 7.17: PROGRAMMING LOGIC FOR JSON DATA EXCHANGE DEMONSTRATION.....	184
FIGURE 7.18: DATABASE SYSTEM DEMONSTRATION .....	185
FIGURE 7.19: PROGRAMMING LOGIC FOR DATABASE MIGRATION FUNCTION DEMONSTRATION .....	186
FIGURE 7.20: PROGRAMMING LOGIC FOR SEED FUNCTION DEMONSTRATION.....	187
FIGURE 8.1: OBJECTIVE OVERVIEW OF CHAPTER EIGHT.....	190
FIGURE 9.1: OBJECTIVE OVERVIEW OF CHAPTER NINE.....	208
FIGURE 9.2: LINKAGE BETWEEN THE RESEARCH QUESTIONS AND THE RESEARCH OBJECTIVES.....	210

## LIST OF TABLES

TABLE 2.1: FORMS OF PURPOSIVELY DEVELOPED EMIS IN TERTIARY EDUCATION SYSTEMS.....	28
TABLE 2.2: COMPARISON OF WEB BASED AND CONVENTIONAL SOFTWARE PLATFORMS .....	40
TABLE 3.1: COMPARISON OF THE LEVELS OF INTEGRATION .....	51
TABLE 3.2: COMPARING SOA AND EAI.....	56
TABLE 3.3: SUMMARY AND COMPARISON OF RELATED WORK .....	77
TABLE 4.1: CODING AND IDENTIFICATION OF RESPONDENTS .....	84
TABLE 4.2: DESCRIPTION OF INTERVIEW QUESTIONS.....	85
TABLE 5.1: REQUIREMENTS FOR DESIGNING SERVICE-ORIENTED FRAMEWORK FOR INTEGRATED EMIS DEVELOPMENT .....	133
TABLE 6.1: CONCEPTUAL FRAMEWORK ANALYSIS FOR INTEGRATED EMIS DEVELOPMENT.....	145
TABLE 6.2: EDUCATION INFORMATION STRUCTURE COMPONENT OF THE PROPOSED FRAMEWORK.....	150
TABLE 6.3: SERVICE-ORIENTED DESIGN COMPONENT OF THE PROPOSED FRAMEWORK .....	151
TABLE 6.4: DEMONSTRATION LOGIC COMPONENT OF THE PROPOSED FRAMEWORK .....	153
TABLE 6.5: DATA EXCHANGE MECHANISM COMPONENT OF THE PROPOSED FRAMEWORK .....	154
TABLE 6.6: DATABASE SYSTEM COMPONENT OF THE PROPOSED FRAMEWORK .....	155
TABLE 7.1: LARAVEL TECHNICAL TOOLS AND SERVICE .....	164
TABLE 7.2: DEMONSTRATION APPROACH OF EDUCATION INFORMATION STRUCTURE COMPONENT OF THE PROPOSED FRAMEWORK .....	168
TABLE 7.3: DEMONSTRATION APPROACH OF SERVICE-ORIENTED DESIGN COMPONENT OF THE PROPOSED FRAMEWORK .....	171
TABLE 7.4: DEMONSTRATION APPROACH OF DEMONSTRATION LOGIC COMPONENT OF THE PROPOSED FRAMEWORK.....	174
TABLE 7.5: DEMONSTRATION APPROACH OF EXCHANGE MECHANISM COMPONENT OF THE PROPOSED FRAMEWORK.....	182
TABLE 7.6: DEMONSTRATION APPROACH OF DATABASE SYSTEMS COMPONENT OF THE PROPOSED FRAMEWORK .....	185
TABLE 8.1: ANALYSIS OF EXPERT REVIEW ON JUSTIFICATION OF THE PROPOSED FRAMEWORK.....	195
TABLE 8.2: ANALYSIS OF EXPERT REVIEW ON ADAPTABILITY OF THE PROPOSED FRAMEWORK .....	195
TABLE 8.3: ANALYSIS OF EXPERT REVIEW ON MAINTAINABILITY OF THE PROPOSED FRAMEWORK .....	196
TABLE 8.4: ANALYSIS OF EXPERT REVIEW ON STANDARDISATION OF THE PROPOSED FRAMEWORK.....	197
TABLE 8.5: ANALYSIS OF EXPERT REVIEW ON SCALABILITY OF THE PROPOSED FRAMEWORK.....	198
TABLE 8.6: ANALYSIS OF EXPERT REVIEW ON CONNECTIVITY OF THE PROPOSED FRAMEWORK .....	198
TABLE 8.7: ANALYSIS OF EXPERT REVIEW ON ACCESSIBILITY OF THE PROPOSED FRAMEWORK .....	199
TABLE 8.10: COMPARATIVE ANALYSIS OF PROPOSED FRAMEWORK WITH EMIF AND SIF BASED ON IDENTIFIED CRITERIA. ....	204

## DEFINITION OF TERMS

<b>Cross-Platform</b>	The ability of an information system or application software to run on multiple platforms with the same functionality
<b>Data Type</b>	It is a classification of data having pre-defined characteristics or type such as Real, Integer, String or Boolean.
<b>Education Management Information System (EMIS)</b>	An enterprise application for collection and processing of cross-platform data to provide analytic for managing the education system
<b>Enterprise Application</b>	It is a component-based scalable system with distributed architecture for handling mission critical complex system in organised environment such as the education institution.
<b>Heterogeneous Environment</b>	This represents platform of different software and hardware components from different vendors.
<b>Information Flow</b>	The transfer of information across different levels in a system or organisation
<b>Information Management</b>	It is a way of capturing, storing, managing, and sharing information across multiples sources
<b>Information System</b>	It is an interconnected system of computing infrastructures (software and hardware) that are designed to manage the effective use of information within an organisation.
<b>Integration</b>	The procedure of connecting different systems together.
<b>Interoperability</b>	This is the means of ensuring that several systems can communicate to exchange information
<b>Programming Language</b>	A set of rules or instructions that the computer follows in executing any given task. Enterprise Applications are developed with a form of programming language.
<b>Seamless Integration</b>	An easy and effortless process of adding new module, plug-in, or application to an enterprise application.
<b>Semantics</b>	The assignment of meaning or interpretation to symbol and formula of a programming language
<b>Tertiary Education</b>	It is a final level of formal education after the secondary or high school education, which is often delivered at the Universities, polytechnics, colleges, or institutes

## CHAPTER 1 : INTRODUCTION

Education Management Information System (EMIS) has become the focus of academic research due to its potential for timely, reliable, integrated, shared and efficient utilization of data for planning and decision making (Sajjad & Awais, 2010) especially in tertiary education system. This chapter sets the template for the research study and is divided into twelve sub-themes, as shown in Figure 1.1, with each theme focusing on specific research issue.

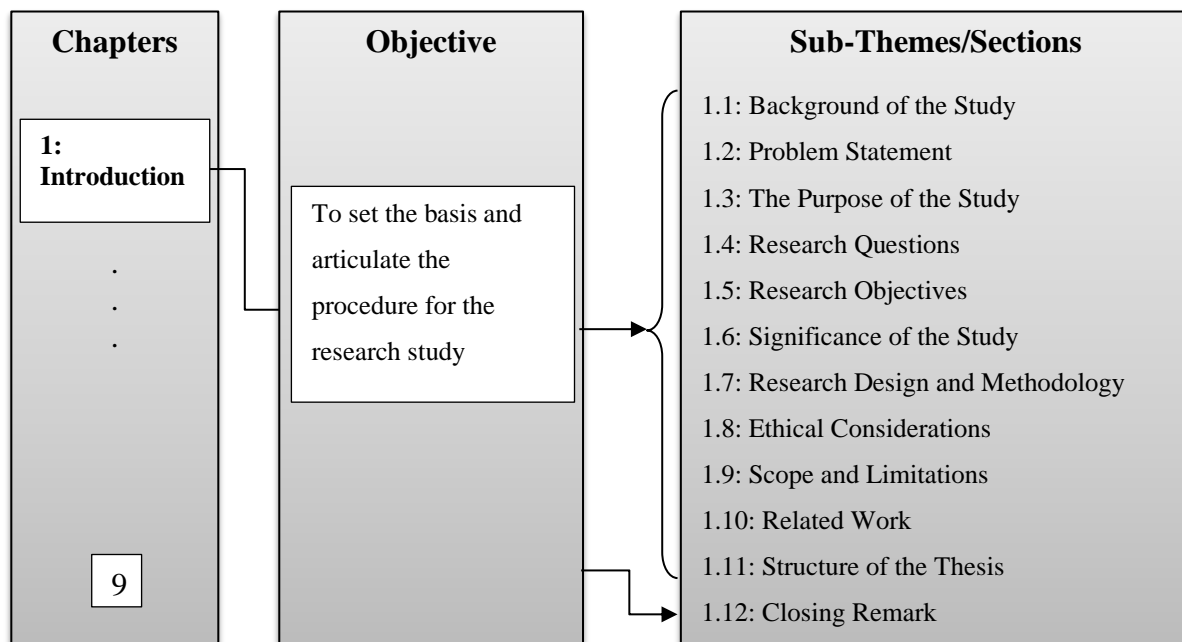

Figure 1.1: Objective Overview of Chapter One

The subtheme on the Background of the Study (Section 1.1) describes the EMIS and the need to integrate EMIS for effective and efficient management of the education system, particularly the tertiary education system. The Problem Statement subtheme (Section 1.2) establishes an argument on the research gap with focus on the need to integrate several EMIS for interoperability and data exchange. The Purpose of the Study subtheme (Section 1.3) clarifies the purpose and outcome of the research study. Meanwhile the subthemes on Research Questions (Section 1.4) and Research Objectives (Section 1.5) state some questions and objectives that clarify the research focus. The Significance of the Study subtheme (Section 1.6) establish an argument for the implication of this study to education institutions and application developers. The Research Design and Methodology subtheme (Section 1.7) clarifies the procedures and approaches for the conduct of the research.

The Ethical Considerations subtheme (Section 1.8) identifies some of the ethical issues that were considered in the course of the research study. The subtheme on Scope and Limitation (Section 1.9) clarifies and consider the key issues that the research study addresses. The Related Work subtheme (Section 1.10) reviews some of the related research studies and identifies their limitations and benefits. The subtheme on Structure of the Thesis (Section 1.11) makes a brief clarification on the layout of the chapters in this thesis. This chapter ends with the subtheme on Closing Remark (Section 1.12) that summaries the arguments in all the subthemes in this chapter.

## **1.1 Background of the Study**

The increasing demand of students and researchers for quality education has put education institutions on the competitive edge but with a lot of inherent challenges (Marinela, 2012). These challenges include the management and administration of key education tasks: enrolment of students into school, collection of staff and students profile information, processing of education fees payment, registration of courses and management of curriculum, assessment and result processing, among others. Most education institutions deploy some forms of Education Management Information Systems (EMIS), to manage these challenges. EMIS has therefore evolved to be an acronym for a system that is used to process information for management of education (Wako, 2003).

The deployment of several and diverse forms of EMIS to handle these education tasks has redefined the means of managing the education system in a more efficient way. Mohd Hasan & Abdulmonem (2009) observed that education institutions are leveraging on the use of EMIS to create a richer electronic environment for students, faculty, and alumni by opting for single entry point for communication, registration, class and content management, collaboration, and research. The observation is premised on the assumption that the EMIS empower students and faculty, lower administration cost, improve information visibility and enable the education institution to achieve business agility.

Inferring from the arguments of (Mohd Hasan & Abdulmonem, 2009; Fu & Liu, 2010; Dongdai, et al., 2010; Aserey & Alshawi, 2013), two possible options are available for the design of EMIS in ensuring that it achieves its full potential in managing key academic processes within the tertiary education system:



- A first option is to approach EMIS as a unified information system, as shown in Figure 1.2 that integrates all functions and modules for all the key academic processes. In which case, the EMIS is developed for a single platform and with a single data source. Thus, the issue of interoperability becomes an internal affair at the application logic layer. This option is simplified for achieving data exchange among interacting modules. It is, however, limited in scope and application as dictated by its development platform or programming language.
- A second option is to consider EMIS as a suit of several enterprise applications, as shown in Figure 1.3, each of which is an EMIS with each application addressing key academic process of the educational institution. It is often the issue in this instance that each EMIS is developed using different platforms with shared or separate data sources. The issue of interoperability is a cross-platform challenge that needs to be addressed during integration for the various EMIS to exchange data across different platforms. This option is more effective, flexible, and scalable, as it allows for the increasing demand for upgrade in the education system, which can be done by different application developers.

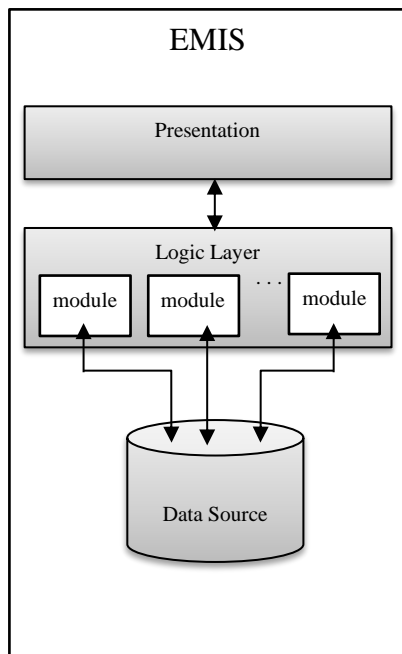

Figure 1.2: Design Approach of EMIS as Unified Information System

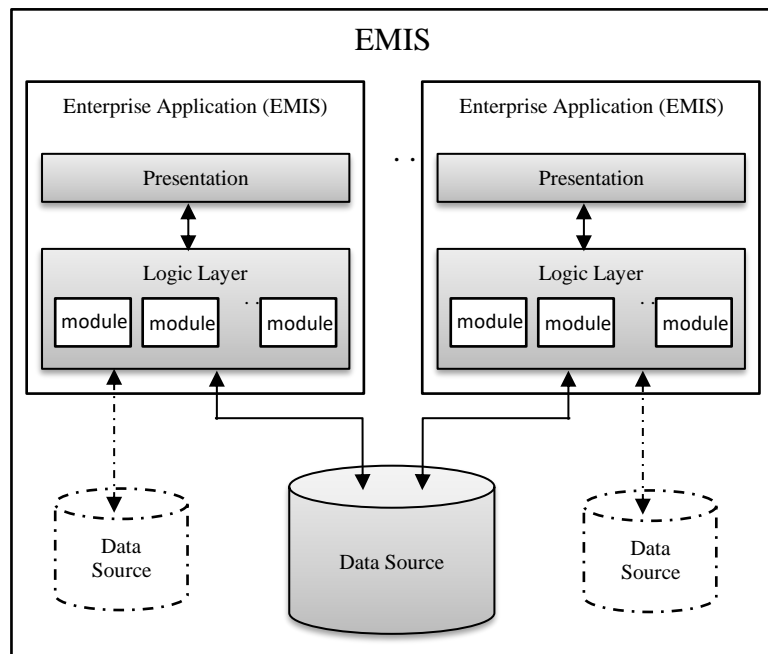

Figure 1.3: Design Approach of EMIS as Suite of Enterprise Applications

From the forgoing, it is evidenced that EMIS is developed for different purposes and context using different languages and standard. The differences in the context, purpose, language, standards have implication on the integration of these different EMIS to interoperate for seamless data exchange.

In the context of the differences in the language and standards, (Dongdai, et al., 2010; Marinela, 2012) argued that EMIS are developed with different operating systems, programming languages and technical standards, which make them to have different information and communication semantics. The difference in the semantics for information and communication exchange of these EMIS creates a challenge with integration resulting from data redundancy, inconsistency and maintenance cost (Aserey & Alshawi, 2013). This problem impacts on the interoperability, security and performance of the various EMIS in sharing information across platforms (Mohd Hasan & Abdulmonem, 2009; Chang & Hsiao, 2011).

In the other context, the submission by Bisaso & Visscher (2005) on a survey that examined the different EMIS that are used by tertiary education institutions raised concern on the different context for the development of EMIS. The EMIS for tertiary education is different from the EMIS for basic education because of their difference in academic structure and curriculum. For these different contexts, the EMIS is developed for different purposes to handle the different tasks in the education institution. The argument by Aserey & Alshawi (2013) justifies the different purposes for which EMIS is developed: student record management, assessment management and financial management, among others. The differences in the context and purpose of the EMIS, which informed their respective underlying logic and structure, limit the integration of the different EMIS to achieve seamless data exchange for cross-purpose data analytic across different education institutions.

Thus, the problem of integration has limited the full potential of EMIS in education. The challenge is to evolve the means of re-defining and standardising the development of EMIS as an integrated system that can easily and seamlessly interoperate. Interoperability allows integrated EMIS to share and exchange data, which is the basis for the use of EMIS to achieve effective administration in the education system (Sajjad & Awais, 2010).

The purpose of this research is therefore to investigate and design a service-oriented technical framework for the development of integrated EMIS to achieve seamless data exchange. The framework is evaluated with a case study demonstration.

## **1.2 Problem Statement**

Most educational institutions, like the universities, have considerable autonomy for academic units, and operate highly decentralised enterprises that allow each unit to choose their computing systems, business rules and operating practices (Liu & Yang, 2008). Thus, there are

various Education Management Information Systems (EMIS) that are deployed to manage information systems challenges at different levels, and which need to be integrated to exchange information for optimal benefits to the education system (IMS Global Learning Consortium, 2009; Aserey & Alshawi, 2013).

However, each EMIS is developed using different programming languages and technical standards (Dongdai, et al., 2010; Bahaa, et al., 2018). Thus, there is the problem of integrating various EMIS together for information exchange (Jakimoski, 2016). There are initiatives on the use of standard integration frameworks like the Education Management Information System Interoperability Framework (EMIF) by the Government of China and the School Interoperability Framework (SIF) by industry experts in the United States of America (USA) to integrate EMIS across several institutions in the education system. However, the complexity in the underlying data exchange mechanism (Dongdai, et al., 2010), absence of conceptual design structure and architecture of the EMIS that can easily be integrated for seamless data exchange (Ise, 2014) and inefficiency in communication channel to transmit large volume of data (Bahaa, et al., 2018) limit their use in education institutions, especially in developing countries with limited technical man-power.

### **1.3 The Purpose of the Study**

The purpose of this research study is to investigate, design, demonstrate and evaluate a service-oriented technical framework for the development of integrated EMIS in tertiary education system in a bid to resolve the inherent challenge of achieving data exchange. It is observed that the difference in the information and communication semantics of various EMIS used in education institutions affects their integration for cross platform information exchange (Dongdai, et al., 2010).

### **1.4 Research Questions**

In this research study effort was to answer the following question:

**How can a service-oriented technical framework be designed for the development of integrated Education Management Information Systems to achieve seamless data exchange?**

In resolving this main research question, the following operational questions will equally be answered:

1. What are EMIS and their integration challenges in tertiary education system?
2. What approaches, technologies and frameworks are currently used for integrated EMIS development?
3. What are the generic principles and requirements for the design of a service-oriented technical framework that could facilitate the development of integrated EMIS?
4. How can a service-oriented technical framework for the development of integrated EMIS be developed and designed?
5. How can the proposed framework for the development of integrated EMIS be demonstrated and evaluated?

The answers to these research questions will form the basis for the research outcome.

## **1.5 Research Objectives**

The main objective of this research study is to:

**Investigate, design, implement and evaluate a service-oriented technical framework for the development of integrated EMIS to achieve seamless data exchange.**

This main objective will be fulfilled through the achievement of the narrower objectives detailed below:

- i. To describe EMIS and examine their integration challenges in tertiary education system.
- ii. To examine the approaches, technologies, and frameworks for the development of integrated EMIS.
- iii. To identify and examine the principles and requirements for the design of a service-oriented technical framework for the development of integrated EMIS.
- iv. To develop and design a service-oriented technical framework for the development of integrated EMIS that can facilitate data exchange.
- v. To demonstrate and evaluate the use and effectiveness of service-oriented technical framework for the development of integrated EMIS of different platforms.

## **1.6 Significance of the Study**

The main objective of using EMIS is to serve as a tool for managing the education system in such an effective and efficient way. Achieving this objective requires that several EMIS are

integrated for interoperability and data exchange. Meanwhile, the options of SOA and EAI for cross-platform information exchange can be used to integrate different EMIS.

The inadequacy of EAI to effectively handle data exchange and the absence of a specific framework for SOA in education has limited their use in integrating various EMIS to promote cross-platform information exchange in tertiary education system. This research study involved the investigates, designs, demonstrates, and evaluates a service-oriented technical framework for the development of integrated EMIS that seamlessly exchange data.

This will serve as a technical guide for enterprise application developers in understanding the information requirements and flow within the tertiary education system and assist to develop EMIS as an enterprise system that can integrate functional and modular EMIS to exchange data seamlessly.

## **1.7 Research Design and Methodology**

The investigation, design, demonstration, and evaluation of a service-oriented technical framework that standardised the design and development of an integrated EMIS to achieve seamless data exchange require a research study that involves a careful design practice, procedure and approaches for data collection, analysis, and interpretation.

In context, therefore, this research study involved the combination of the phenomena of design with methodology to address the basic purpose and objective of the research, which is to provide answers and proffer solution to research questions and problems (Marczyk, et al., 2017).

In undertaking a research study, the researcher chose a methodology that is relative and appropriate to the context of the study being undertaken. However, the choice of the methodology, which specifies the methods, approaches and procedure for conducting the study (Creswell, 2009) is a function of the nature of the research problem (Baharein & Noor, 2008; Gray, 2014). Finding a solution to the identified research problem, therefore, requires an adoption of a proper research design and methodology that details the procedure for resolving the complexity of the research problem (Marczyk, et al., 2017) through a practicum demonstration of knowledge.

Runeson & Höst (2009) while citing Robson (2002) classified the key purposes and objectives of research methodology as: exploratory for gaining new knowledge and insight into a research

area; descriptive for describing a phenomenon that illustrates complex research problem; explanatory for providing explanation to a research problem; and improvement for seeking to improve certain knowledge of a research area. A research study satisfies one or combination of these purposes.

Creswell (2009) argued that a research study must address the questions of epistemology (theory of knowledge), methodology (strategy and plan of action) and the methods of data collection and analysis. In line with this argument, this researcher set out to investigate, design, implement and evaluate a service-oriented technical framework for the development of integrated EMIS to achieve seamless data exchange from the ontological perspective (knowledge area) of realism - a belief that knowledge can be built on existing body of knowledge through theories and discoveries (Gray, 2014).

The research study considers an epistemological stance from the post-positivism perspective. This is considered a careful observation of the objective reality (Creswell, 2009), which base conclusion on the analysis of empirical data that can be done “through interpretative collaboration with other viewpoints” (Panhwar, et al., 2017). The study is also explanatory with inductive reasoning. In doing this, it adopts the narrative strategy by considering a mixed method approach that considers literature review, expert interviews, and expert review as tools for data collection. Meanwhile, content, and thematic analysis are considered as tools data analysis. The collected data is used as requirements to design and evaluate a service-oriented technical framework using the conceptual design abstraction technique.

The mixed method approach considers a combination of qualitative and quantitative approaches to the study at different level of the research activities: investigation, design, demonstration, and evaluation. The mixed method allows the researcher to use qualitative approach for data collection and analysis to understand complex phenomena and to use the quantitative approach to explain the phenomena using numbers and statistical analysis in the same study (Creswell, 2009).

This research study is designed on the principle of mixed method research study approach by carefully highlighting distinctive steps and describing the applicable methods of carrying out activities at each stage. The details of descriptions of the research design and methods or tools used are discussed in the following subsections.

### **1.7.1. Research Design and Approach**

The outcome of this research study is a service-oriented technical framework for the development of integrated EMIS, which is considered as an artefact. For a study of this type, the use of a Design Science Research Methodology (DSRM) is found appropriate as a qualitative research approach. The relevance is justified on the ground that DSRM is focused and placed emphasis on artefact as outcome of study (Baskerville, et al., 2018; Hevner, et al., 2019). However, Peffers, Tuunanen, Rothenberger, & Chatterjee (2007) described DSRM as principle, practice, and procedure of conducting research using these six (6) identifiable steps:

1. Identifying the Problems and Motivation
2. Defining Objective for the Solution
3. Design and develop the solution
4. Demonstration of the Solution
5. Evaluation of the Solution
6. Communication of the solution.

These steps are grouped by Offermann, Levina, Schönherr, & Bub (2009) into three (3) key distinctive processes: problem identification, solution design and evaluation. Meanwhile, Sonnenberg & Brocke (2012) also reviewed the six (6) steps of the DSRM and summarised them as two-layer processes that focus on building and evaluating artefacts.

However, Hevner, Brocke, & Maedche (2019) described DSRM in the context of digital innovation (DI) space to produce DSRM artefact as comprising six (6) roles:

1. Understanding of the DI problem space
2. Design of a DI technical artefact
3. Design of an Artefact for deployment and use of a DI artefact
4. Design of a socio-technical DI system
5. Development of Design Theories surrounding a DI artefact
6. Use of a DI artefact as a creative tool in the DSR solution process.

The six steps of the DSRM and the re-grouping into three key distinctive processes were adopted by this study. This is based on the premise that it clearly aligned with the purpose of the research which is to investigate, design and evaluate a service-oriented technical framework for integrated EMIS development.

The activities and tools used in each step of the DSRM, for this research study, are provided thus:

- **The Problem Identification Process Stage** – The research gap is identified in the proposal through a qualitative approach of in-depth literature review and research questions and objectives are set. Data is collected through the conduct of semi-structured interviews with Directors and Programmers at the Information and Communication Technology Centres of purposively selected five (5) Universities in Ogun State, Nigeria. The data from literature were used to clearly define the problem and capture requirements for a solution design.
- **Solution Design Process Stage** - The research outcome is designed as a conceptual framework using qualitative approach of inductive concept analysis. The requirement for the design is captured from the analysis of the data collected from thematic analysis of the semi-structured interviews which formed the findings from the research study. The qualitative inductive data analysis was used to establish arguments for the technical requirements for the design.
- **Evaluation Process Stage** - The design artefact is evaluated on the basis of single case study demonstration using expert reviews and comparative analysis with other EMIS integration frameworks. The focus is to demonstrate and benchmark the effectiveness of the proposed framework as standard for developing an integrated EMIS that seamlessly exchange data. The evaluation is based on the identified requirements, from the research findings, for the design and development of integrated EMIS. Meanwhile, the expert reviews, using close-ended questionnaire, served as further source of data collection method to check the framework for effectiveness and relevance. At this stage, the quantitative approach of using statistical analysis to evaluate and discuss the findings from the expert review is applied.
- **Communication of the Solution:** The investigation part of this study was presented at academic conferences for review. The analysis of findings from this research study and the demonstration of the research outcome was presented at postgraduate seminars for constructive engagement and input into the final proposed framework – artefact. The ultimate is the communication of the research outcome in this thesis.



### 1.7.2. Conceptual Research Design

The flow of the research design and methodology for this study is based on the steps and approaches in the Design Science Research Methodology (DSRM). This is conceptualised and presented in Figure 1.4.

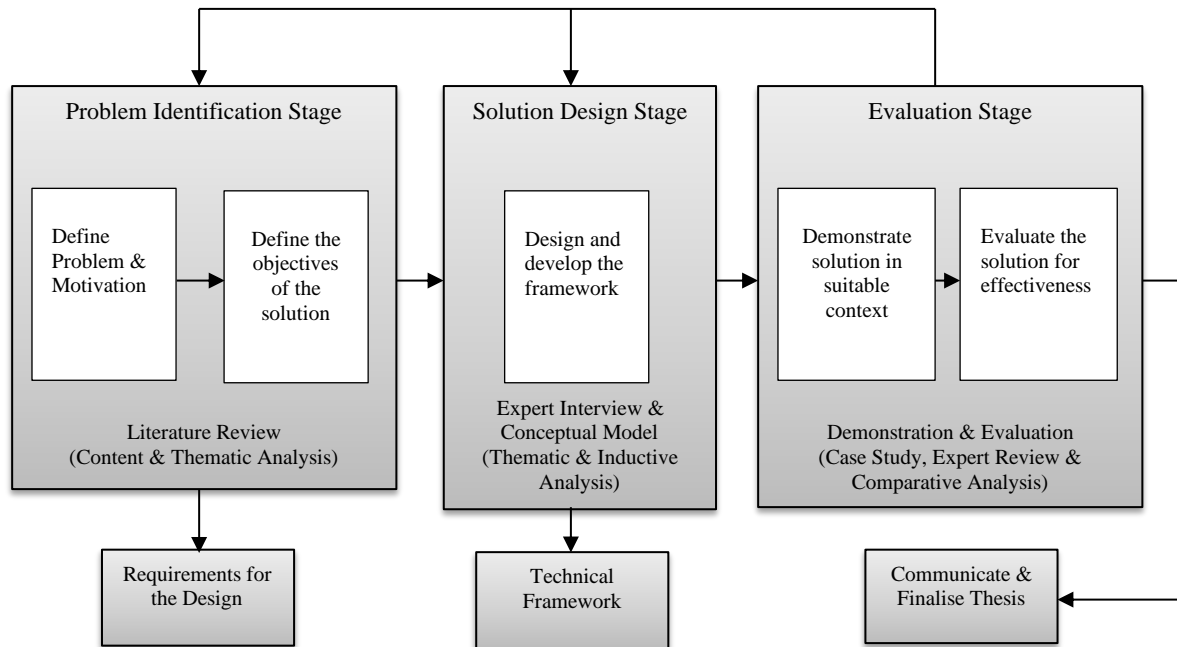

Figure 1.4: Conceptual Study Framework for Research Design and Methodology

The six steps in the DSRM were grouped into three (3) stages with clarifications on the applicable research methods and tools that was used at each stage. The Problem Identification stage comprised the Problem Definition and Solution Objectives steps; Literature Review was applied as research tools for data collection method using the content and thematic analysis as tools for data analysis. The Solution Design stage comprised the Framework Development step using the Conceptual Modelling approach; Inductive Reasoning Analysis was used as conceptual design tool based on Thematic Analysis of data that are collected from Expert Interviews. The Evaluation stage comprised the Demonstration and Evaluation of the Solution steps using the Case Study and Expert Reviews as tools for demonstration and evaluations. The final step involved the communication and presentation of research findings and knowledge contribution in this thesis. The structure of the thesis, in alignment with this conceptual research design, is presented Section 1.11 and the diagrammatic representation presented in Figure 1.5.

### **1.7.3. Sample Population and Design**

Clark (2013) argued that sample design has limited information, and that a well-designed sampling plan enhances the survey information. This research draw sample from a limited space on tertiary education institutions, specifically, Universities. The university is preferred sample space due to its status as the highest level of formal education with capabilities for distributed systems – using different EMIS at different levels of faculties and departments. Other tertiary education institutions model the university, in a way.

Collecting information requirements of Universities in Nigeria for use in the design and evaluation of a service-oriented technical framework for the development of an integrated EMIS require taking a sizeable sample of universities within an education district. The choice of Ogun State is adequate as the state occupies a central position in Nigeria as far as education is concerned.

A sizeable five (5) Universities in Ogun State, Nigeria was purposively selected for the sample space. The purposive selection was to focus on universities that use EMIS within the locality and to be a representation of all other universities since they share similar requirements and are regulated by the National University Commission (NUC), the regulatory Agency for university education in Nigeria. Participants, who are directors and application programmers at the selected university's ICT centres, were then chosen for expert interviews. The selection was done to ensure that the research study is focused on technology (design, development, demonstration, and evaluation) as it relates to the use of EMIS in the university system.

### **1.7.4. Case Study Approach**

The case study approach, which has the goal of providing detailed description of the study case (Marczyk, et al., 2017) and testing the viability of a research proposition in a case-study environment, is used in this research study to demonstrate the research outcome.

Gustafsson (2017) while citing Solberg Søylen & Huber (2006) argued that case study is widely used in research study but with no generally acceptable definition because there is no clear explanation on its description. However, Runeson & Höst (2009) described the characteristics of the case study approach to research in the context of its being flexible, evidenced-based and incremental approach to building knowledge.

The consideration and strength of these case study characteristics is based on its lack of experimental control and naturalistic method, which set it as a distinctive and valuable data collection method that complement research study and practice (Marczyk, et al., 2017). Thus, case study approach is adequate in supporting scientific research. However, its key objective and application to this research study is to demonstrate the functionality and effectiveness of the proposed framework.

However, Gustafsson (2017) raised argument on the use of single and multiple case studies as formats and approaches for the application of case study to research study base on the number of contextual cases that is being studied. Gustafsson (2017), however, argued further that the multiple case study is more convincing with larger empirical evidence but time consuming and expensive to conduct. Meanwhile, the single case study provides a basis for correlating the case study with existing studies to gain better depth of understanding, but the limitation is in the representativeness of the single case study to the phenomena that is being studied.

In the context of this study, the single case study approach is considered as a type of case study *“that allow for the examination of the detailed unfolding of events across time in the context of the case as a whole”* (Widdowson, 2011). However, the descriptive type of single case study (Baxter & Jack, 2008) or classical case study (Ridder, 2017) approach is adopted to describe the phenomena of the proposed framework within the context of the case study environment.

The Tai Solarin University of Education (TASUED), Ogun State, Nigeria was considered for the single case study environment to demonstrate and evaluate the proposed framework. The consideration is justified on the ground that the university is easily accessible to the researcher and use various EMIS that require integration to exchange data.

#### **1.7.5. Data Collection Methods**

Data collection in empirical research study could take the form of quantitative where the data can be numerical form or qualitative where the data can be of the descriptive form to exploratory purposes (Runeson & Höst, 2009). For this qualitative research study, literature review, interviews with expert reviews and observation formed the primary sources of data collection.

The process involved in each of the data collection method is discussed below.

**i. Literature Review**

Creswell (2009) argued that literature review enhances quality of research study by sharing knowledge of related studies, extend prior knowledge and providing a framework for comparing findings from studies. In this regard, a collection of literature (academic journal, conference proceedings and relevant books) and technical reports from related standard organisations on EMIS and SOA as Integration technology were carefully selected, read, reviewed, and analysed based on content and thematic analysis. The selection, review and analysis were done with focus on the research objective.

**ii. Experts Interviews**

The interviews were semi-structured; they were carefully chosen to guide the discussion while allowing the participants the flexibility to raise new and relevant ideas (Baharein & Noor, 2008) that were not captured in the initial interview questions and to carefully identify and strengthen argument for the research objective. This was considered necessary to enhance the quality and relevance of the data collected. The following steps were observed during the data collection process:

- Interview questions were prepared, in categories, to reflect all the thematic areas of the research – EMIS, Integration and SOA
- Separate interviews were scheduled with the target audience (directors and programmers at the University ICT Centres of purposively selected Universities in Nigeria), at their convenience, in different sample domains (Universities). A minimum of three (3) participants in each domain were scheduled together to avoid disappointment and full complement of knowledge sharing among participants.
- Familiarity with the interview question was ensured with the participants being briefed of the structure of the interview to allow for suggestions of new ideas.
- The interviews were conducted within the University environment of the participants to create a platform for them to demonstrate their technology in support of their arguments, when necessary and at their discretion.
- The interview process was carefully moderated and guided to keep the focus; every response of the participants to each interview question were carefully noted in writing to allow for reference. Additionally, there were video recording of the interview sessions to assist with playback.

### iii. Expert Reviews

As an added layer of data capture process and deliberate measure of the evaluation of the research outcome, the expert reviews through close-ended questionnaires were used by the researcher in the evaluation of the artefact. The expert reviews focused on practice experts to ensure that the reviews and recommendations are centred around the technical considerations on the effectiveness of the proposed service-oriented technical framework for the development of integrated EMIS. Ten (10) purposively selected practice experts in the design, development, and administration of EMIS in tertiary education institutions including Applications Programmers and Directors of Academic Planning were contacted to share their views of the proposed framework through the close-ended questionnaire that was shared. Feedbacks from the questionnaires were analysed on a Likert scale to evaluate the proposed framework.

#### 1.7.6. Data Analysis Technique

The data obtained from the review of literature, expert interviews and reviews of the artefact's evaluation were analysed using relevant qualitative research data analysis techniques: content and thematic analysis. Onwuegbuzie, Leech, & Collins (2012) established arguments for the relevance of content and thematic analysis for qualitative data analysis with these descriptions:

- Classical content analysis** Systematic reduction of contents in the literature to codes by deductive or inductive means and then counting the number of codes.
- Manifest content analysis** Describing the aspects of communication from observation by objective, systematic, and empirical means
- Thematic analysis** Searching for relationships among topical issues and how these relationships are linked to the overall objective

The classical approach to content analysis and thematic analysis were used to analyse the data that were collected from the review of literature. This is done by inductively coding some of the major points and arguments that were raised by authors in the literature documents and then arranged in topical or thematic category to align with the research study objective.

Meanwhile, the manifest content analysis approach was used to analyse expert review that were made during the evaluation stage of the artefact. The analysis was done by taking objective and

systemic view of the of the responses in the close-ended questionnaire from expert review and aligning it with the requirements obtained at the design stage to establish argument for concurrence with the study objectives.

However, recursive abstraction was used to analyse notes of discussions taken during the interviews with experts. The recursive abstraction method of qualitative data analysis is described in six (6) steps by Polkinghorne & Arnold (2014) and were followed in this research study to examine and analyse the interview data.

- i. The response of each participant to each question is written as a transcript and important points are highlighted
- ii. The question and the corresponding highlighted points from each participant are moved into separate column to form a table.
- iii. Each highlighted point of each respondent is reframed into concise bulleted points
- iv. Related questions on similar topical issue were combined to form a theme and repeated bulleted point removed
- v. Each bulleted point is coded as a simple word or phrase without losing meaning. Steps (iv) and (v) were repeated to condense and combine related themes and codes
- vi. The key issues in the table were then arranged against key theme to form a pattern of information.

The information from content, thematic and recursive abstraction analysis was combined with Requirement Analysis technique to examine the functional requirements for the design of a service-oriented technical framework for development of integrated EMIS. Meanwhile, quantitative statistical analysis was used to analyse and discussed the questionnaire feedback from expert review.

#### **1.7.7. Data Quality Control**

To ensure the quality of results in this study, consideration was given to the issue of reliability and validity of data collection methods and analysis. Golafshani (2003) argued that the issue of reliability and validity of data in qualitative research paradigm can be conceptualised as trustworthiness on the part of researcher, rigour and quality of data collection and analysis adopted in the research process.

This research study, therefore, considered and adopted some data quality control measures. These measures are stated thus:

- Data were collected from multiple sources to ensure the validity of arguments
- All data collected were continuously monitored and cross-referenced for consistency
- The research instruments were carefully selected to ensure their relevance for reliable and valid data collection and analysis
- The principle of research ethics considerations regarding informed consent, privacy, accuracy, and confidentiality was followed to align with the key features of qualitative research design.

The researcher's credibility was ensured by focusing on the objective truth of the research study.

### **1.8 Ethical Considerations**

This research study followed ethical considerations by applying for the UNISA ethical clearance. The interview with experts, as one of the sources of data collection, was conducted with respect for their privacy, confidentiality, and thoughts (UNISA, 2014). Some of the ethical issues that were considered are given thus:

- Confidentiality agreements
- Protection of participants' identity
- Consent and optional participation of participants
- Right to refuse to answer questions or discontinue interview process at any time
- Participant release agreements

### **1.9 Scope and Limitations**

This research study covered mainly the investigation, design, demonstration, and evaluation of service-oriented technical framework for the development of integrated EMIS that can seamlessly exchange data. In this regard, the scope of the research addressed the issue of using service-oriented approach to design a technical framework of integrated EMIS development to achieve seamless data exchange. The scope of the EMIS is to cover the tertiary education system; with a focus on EMIS for a University as a representation of tertiary education system. The framework was limited to addressing integration for interoperability with focus on data exchange while taking considerations for scalability but not performance and security.

## 1.10 Related Work

This research study examined the literature on recent studies in relation to the integration of EMIS as an information system that is used in the education system. The details of the design and architectures used by the different authors in the related work are discussed further in different subsections under the section 3.7 that reviewed the different case studies of the application of integration approaches and technologies to EMIS. In this section, we provide a summary of related work for purposes of highlighting relevance and significance of the research problem stated in this chapter.

Yunyun & Huakun (2010) argued, as discussed in Section 3.7.1, for a multi-tiered EMIS system based on web services with the use of the Zone Integration Server (ZIS) as provided for in the Education Management Information System Framework (EMIF), to integrate EMIS of different platforms and programming languages. The multi-tier system allows functional modules in EMIS to be wrapped as web services that interact with the database through the Open Data Base Connectivity (ODBC) middleware. This makes it easier for various EMIS to consume a service irrespective of its development platform and language. However, there is a complexity in the channels of communication across the multi-tiers: data model, web services and user layers.

In another perspective of using the EMIF, a service-oriented interoperability model using web services technologies, wrapped as software agents, to integrate various education management information systems was argued, as discussed in Section 3.7.2, by Dongdai, et al. (2010). The use of agents that are deployed at both ends of the EMIS and ZIS makes integration of EMIS achievable. However, the integration of EMIS is limited to agents' communication with the ZIS and a breakdown of the ZIS disrupts the EMIS integration.

Chandio, Zhu, & Sodhro (2012) also established an argument, as discussed in Section 3.7.3, for SOA with web services to design a system of interconnecting different information systems in a University. The Integration of Inter-connectivity of Information Systems (i3) was developed with an open-source SOAP engine as a project on the Apache software foundation for the implementation of web services. Integration is achieved with the system by connecting different system to the system i3, which acts as a middleware. However, there is an unhealthy dependency on the system i3 by other information systems in the University; any breakdown of the system i3 will disrupt the EMIS integration.



In the alternative, Enterprise Application Integration (EAI) is argued, as discussed in Section 3.7.4, by Aserey & Alshawi (2013) with the design of a Higher Education-EAI (HE-EAI) adaptation model as a mean of integrating multiple information systems in higher education to facilitate information access and re-use. The HE-EAI provides an integrated view of all the connected information systems with an EAI infrastructure serving as a middleware. However, there is a lack of standard and technical details on the data exchange mechanism in the EAI architecture.

In a recent effort, as discussed in Section 3.7.5, Bahaa, Sayed, & Elfangary (2018) proposed a secured interoperable model of data exchange across different educational institutions using RESTful API with standard data format for communication. The model also proposed a Cross Platform Web Application Interoperability Protocol (CPWAIP) for establishing communication between the internal and external components of the proposed interoperability model. While the model provided a simplified and secured communication standard for data exchange between services in different educational institutions, there is lack of details and standardization in the design and development of EMIS as integrated systems with extensible functionalities that capture the key tasks in the education system.

A cursory appraisal of these related work reveals the use of EAI and SOA as two possible underlying design approaches to EMIS integration. These two approaches are further discussed in Section 3.3. Noteworthy, the use of EMIF as standard framework using the web service and agent technologies for integration also takes prominence. Meanwhile, the complexity in the semantics of the EMIF and web service technology is a major challenge to EMIS integration.

## **1.11 Structure of the Thesis**

This research thesis is structured into three parts: preliminary part, main body, and the appendices. The main body of the thesis is arranged into chapters with each chapter addressing a key thematic issue in the research study. Each chapter is broken down into sub-themes to properly organise and strengthen the flow of arguments in the chapter, which are systematically linked with other chapters by front and backward argument connections. Meanwhile the appendices highlight all the important resources used in this thesis.

Chapter 1 (one) is the introduction to the research study and clarifies the proposal for the design, demonstration, and evaluation of service-oriented technical framework for the development of integrated EMIS. The chapter focuses on the background study of the research

and includes an overview of the research problem statement, purpose of the research study, research questions, research objectives, significance of the research study, research design and methodology, scope and limitation of the research study and examined some related research work.

Chapter 2 (two) contains a review the literature on Education Management Information Systems (EMIS) and its use in tertiary education systems. The chapter also raised arguments on some of the technical considerations in the design of integrated EMIS: development platform, data handling, programming language, design architecture; and then examined some of the benefits and limitations of using EMIS.

Chapter 3 (three) is a discussion on key considerations, design approaches and standard technologies for achieving the integration of various EMIS. The chapter also reviewed the two common integration frameworks and some selected case studies of EMIS integration.

Chapter 4 (four) discussed the procedure of the research findings and raised arguments on some thematic areas from the analysis of the research findings: Significance of EMIS; Structure and Architecture of EMIS; Process of EMIS Development; Data Processing and Exchange in EMIS; Platform for EMIS Development; Approaches to EMIS Integration; and Design Standard for Integrated EMIS.

Chapter 5 (five) raised argument on the principles and requirements for the development of integrated EMIS that can facilitate the design of a service-oriented technical framework. The identification of the principle and requirements were based on inductive reasoning analysis of the thematic areas of the research findings.

Chapter 6 (six) proposed the design of a service-oriented technical framework for the development of integrated EMIS that allows for seamless data exchange based conceptual abstraction of key concepts from the analysis of the research findings.

Chapter 7 (seven) discussed the case study demonstration of the proposed technical framework.

Chapter 8 (eight) raised discussion on the evaluation of the proposed framework on the strength of argument from the quantitative analysis of the responses from the expert review and qualitative comparative analysis of the proposed framework with similar existing framework.

The evaluation criteria are referenced within the context of the requirements that were established from the research findings.

Chapter 9 (nine) summarised the thesis with arguments connecting the research questions to the objectives. Arguments are also raised to justify the research contributions; and identified areas of future research work that justify the scope and limitation of the research outcome.

A diagrammatic representation of the chapters' layout in line with the three stages (Problem Identification, Design and Development, and Evaluation) of the research methodology (Design Science Research Methodology) that is adopted for this research study is presented in Figure 1.5 for clarity and brevity of purpose.

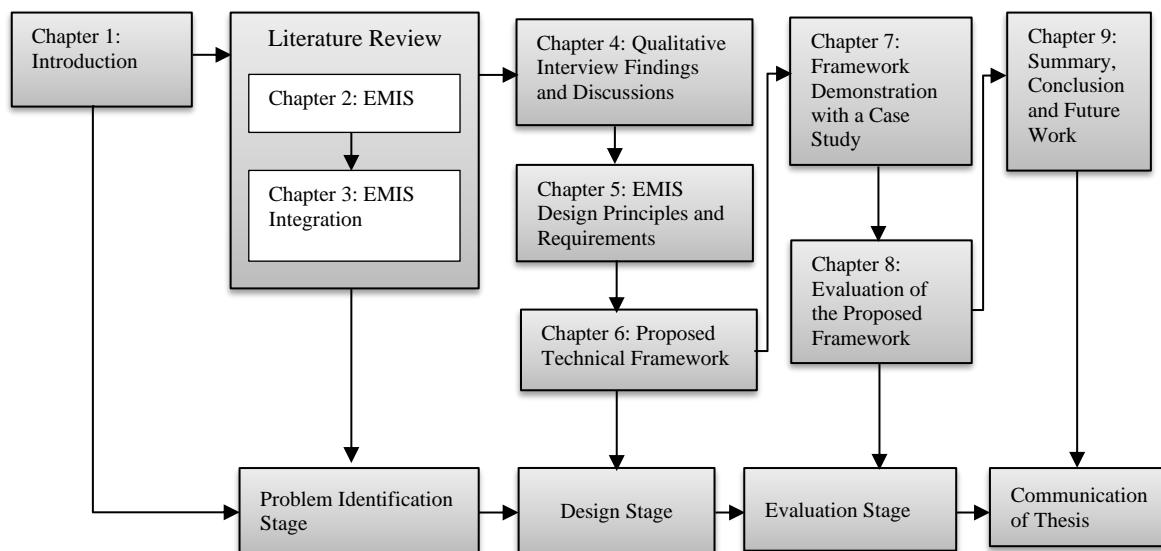

Figure 1.5: Structure of the Thesis combining Chapters and Stages in DSRM

## 1.12 Closing Remark

The arguments in this chapter focused on the significance of EMIS as an effective and efficient tool for managing the education system. The two possible options in ensuring that EMIS achieve its full potential was examined: as a unified application or enterprise solution. The option of the EMIS as an enterprise solution, which allows several applications with each application addressing specific academic activity, is argued as appropriate for being flexible and scalable. However, the issue of having each EMIS application being developed with different languages and platforms was identified.

The need to develop an integrated EMIS to achieve interoperability for data exchange was raised in the problem statement of this research study. The EAI and SOA were overviewed as possible integration technologies with SOA being preferred for its support for platform independence, re-usability and support for programming paradigm and standard technologies. The purpose of the research is set as: to investigate, design, implement and evaluate a service-oriented technical framework for the development of integrated EMIS in tertiary education in a bid to resolve the inherent interoperability challenge of achieving data exchange.

To expand the main research question and objective, four other research questions were raised with corresponding four research objectives as guide to the research study. The research design and methodology is argued in this chapter to focus on a qualitative approach of capturing data from review of literature and discussions with experts while using data analysis tools (content analysis, thematic analysis and recursive abstraction) to cross-reference the facts; on the strength of which the service-oriented technical framework, as the research artefact, is designed, demonstrated and evaluated with a case study demonstration.

An extensive appraisal of related work on EMIS integration was conducted. The review revealed that the argument on EMIS integration can be achieved from different technology perspectives. These include the use of SOA with Web Service, SOA with Agent Services, SOA with Middleware, EAI with Middleware and Interoperable Model with RESTful API. The summary of the review process identified the common use of SOA and EAI technologies to achieve integration for data exchange against their limitations. The review also examined the strength of SOA with web services for integration to include loose coupling of services and a standard support for data communication and serialisation.

However, the limitation on the absence of standardised procedure and complexity of services or agent communication, and limited focus of the design structure of EMIS that can easily integrate with others create a gap in the literature for the development of integrated EMIS that exchange data seamlessly.

## CHAPTER 2 : EDUCATION MANAGEMENT INFORMATION SYSTEM

This chapter examines the literature on Education Management Information Systems (EMIS) and identifies the technical consideration for its development. The objective is to describe EMIS and examine their challenges in tertiary education system, as represented in Figure 2.1.

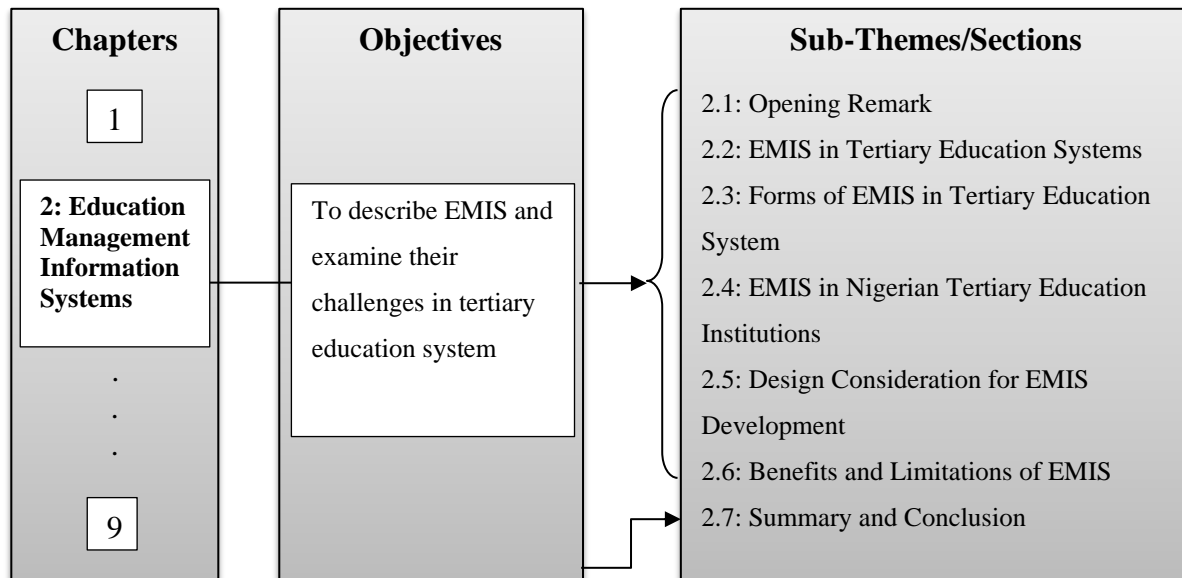

Figure 2.1: Objective Overview of Chapter Two

The chapter contributes to the research study by reviewing the literature and assisting in answering the first research question:

**i. What are EMIS and their integration challenges in tertiary education system?**

The arguments that are observed in the literature are presented in the following seven (7) subthemes; each focusing on specific topical issue.

The Opening Remark subtheme (Section 2.1) describes EMIS as a productive and proficient tool for managing the education system. The EMIS in Tertiary Education System subtheme (Section 2.2) takes a critical assessment of EMIS with particular focus on tertiary education system by examining the broad components of EMIS at the internal and external levels. The subtheme on Forms of EMIS in Tertiary Education System (Section 2.3) examines the forms of EMIS that are used in the tertiary education system with an overview of some specific EMIS that are used in some Nigerian tertiary education institutions. The EMIS in Nigeria Tertiary Education Institution subtheme (Section 2.4) examines the policy dimension to the structure of education in Nigeria and justify the effort at using EMIS to strengthen the education system.

The Design Considerations for EMIS Development subtheme (Section 2.5) reviewed the five (5) key technical considerations that are applicable to EMIS development. The subtheme on Benefits and Limitations of EMIS (Section 2.6) discusses some of the key benefits of EMIS to tertiary education systems and examines some of the EMIS challenges or limitations. Meanwhile, the Closing Remark subtheme (Section 2.7) summarises the arguments that are raised in this chapter and draws conclusions that provide answers to the salient research question that is connected to the objective of this chapter.

## 2.1 Opening Remark

As observed in every other area of human endeavour, the management of information systems is germane to the administration of education institutions. EMIS, as an education specific management information system, is found to be vital in modern day management of the education system. However, Hua & Herstein (2003) argued that the design essence of EMIS is its ability to make meaningful changes to the education system.

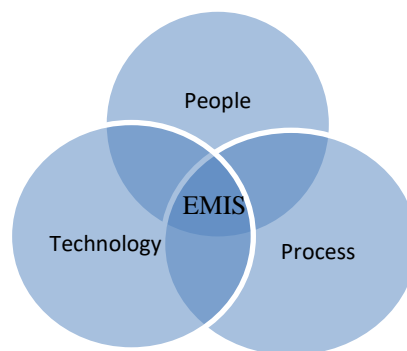

Figure 2.2: EMIS as a Support System

Kurt (2001) also argued on the critical importance of EMIS to the education system. It is regarded as a tool and comprehensive education support system that has the capacity of bringing people, process, and technology together. This is shown in Figure 2.2. The essence of EMIS is to ensure the provision of timely and cost-effective presentation of user appropriate information that is needed at whatever level of the education system. Thus, EMIS is an important factor in education system that should be given attention. It is, however, distinct, and not the same as other forms of Information Systems such as the Statistical Information System (SIS) or Decision Support Information System (DSIS) that could be used in the education system for some other purposes.

Within the context of reliability and timely processing of information, such as enrolment data that inter-connect students and costs analytics in education institutions, Kurt (2001) raised the argument that an integrated EMIS is critical to achieving this objective. This further establishes the significant importance and need for integrated EMIS to handle processes in education institutions.

Observing the above arguments on the description of EMIS, from the technology perspective, it can be argued that EMIS is a definite design tool and comprehensive system of interconnecting functionalities for managing processes and making meaningful changes that optimise activities in the education system. It is also arguable that several EMIS are used to manage several and separate education tasks, for instance, enrolment, course selection, result processing, student and staff profile management, among others. This argument is substantiated with the assertion from Mohd Hasan & Abdulmonem (2009), which posited that the use of different forms of EMIS to address each of the education activities has offered a productive and proficient tool for managing the education system.

The productivity and proficiency of EMIS to deliver reliable and timely information in the education system can be evaluated based on some carefully identified criteria. Hua & Herstein (2003) identified these criteria on the strength of EMIS' ability to provide basis for:

- i. Collection and processing of data for analytics and statistics.
- ii. Request handling for storage and retrieval of data
- iii. Interoperability of data from multiple integrated sources

It is therefore necessary to describe a productive and proficient EMIS as one that is technically designed on a standard framework to exchange data with several other integrated EMIS or other external information systems.

## **2.2 EMIS in Tertiary Education System**

The tertiary education system comprises all forms of post-secondary education, including but not limited to the university. The university, being the highest level of education system with layered structure of faculties and departments, requires an integrated EMIS to manage and coordinate the flow of information across the several Information Systems that are used at its different levels.

Meanwhile, Ekundayo & Ajayi (2009) classified the tertiary education system into two-level system and raised the argument that an integrated EMIS is required to address the two levels: the internal system that defines the structure of the education system and the external level that integrates the tertiary education with the external sources like the government and development partners. However, Ali (2013) expatiated the argument with identification of three (3) distinctive categorisations of EMIS at the internal level of tertiary education system:

- i. Higher Education Student Information System (HESIS) – The HESIS addresses connected information about students. It has two subsystems: teacher-student and student-management information exchange systems.
- ii. Internal Management Information System (IMIS) - The IMIS handles information flow and exchange across faculties and departments – academic and managerial divisions.
- iii. Open-Source Information System (OSIS) – The OSIS, such as the electronic Library Information Systems (e-LIS), provides platform for interactions and exchange of learning and research resources to education stakeholders: students, lecturers, and researchers.

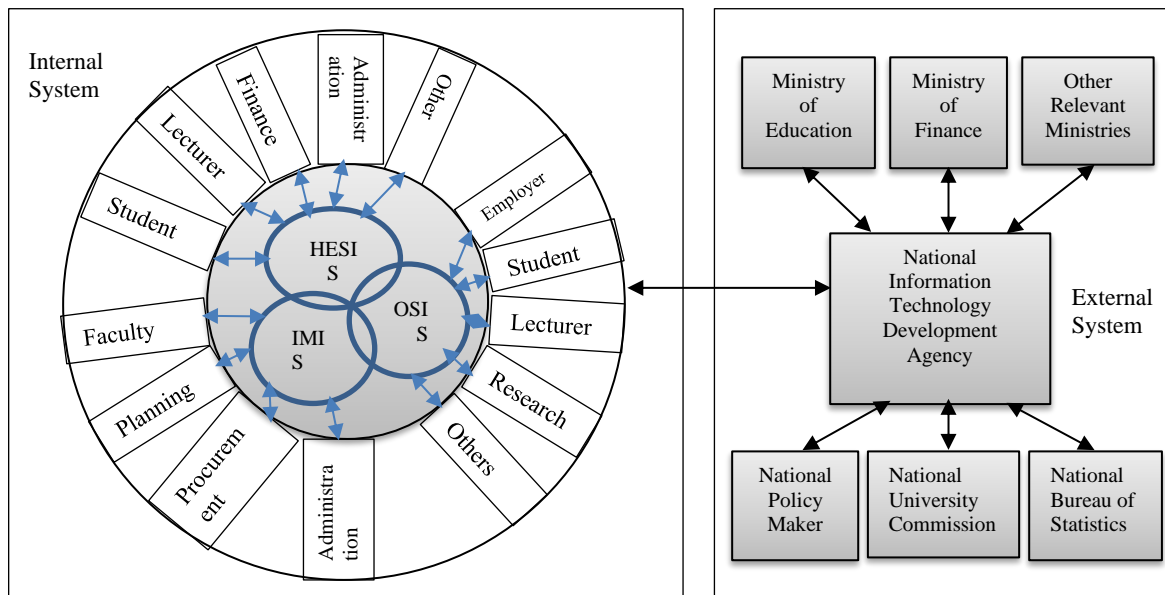

Figure 2.3: Information Flow across Levels in Tertiary EMIS adapted from (Villanueva, 2003)

The structure of EMIS that is used in the tertiary education system is, therefore, defined by an interaction between the information and exchange systems at its internal and external levels as represented in the Figure 2.3. Meanwhile, (Aserey & Alshawi, 2013) stressed the need for strategic technical considerations for the integration and coordination these systems to make



the EMIS accessible to all stakeholders in a comprehensive form (Villanueva, 2003). The interactions between the systems at the internal and external levels of the tertiary education system that is represented in Figure 2.3 is adapted for Nigeria context based on proposition from (Villanueva, 2003).

Taking a critical assessment of the components part of the internal system in the tertiary EMIS, it can be argued that the focus is the design of EMIS for academic and administrative purposes. The academic activities are related to the students and staff, with respective faculty or academic unit, in such functional areas of teaching, learning and research (Ali, 2013). Meanwhile, the administrative activities are related to the management of the cross-sectional information from the various academic activities for purpose of administration, planning and decision making.

Meanwhile, the external systems interact with the internal systems of EMIS to source information that can assist in their policy planning and decision-making relative to the education system. These external systems could be the functional ministries, departments, and agencies (MDAs) of government or donor agencies that require information on education statistics. For instance, the students' enrolment and graduation information, generated at the internal system of EMIS, can be coordinated by an external agent and shared across relevant MDAs. In the Nigerian context, such information from the internal layers can be shared or sourced by the National University Commission, Ministry of Education, Ministry of Finance, Department of Statistics, and other relevant MDAs for different purposes relating to national planning and development.

### **2.3 Forms of EMIS in Tertiary Education Institutions**

Guo & Song (2010) described EMIS, in tertiary education system context, as a complex system for managing education activities. These activities involve tasks such as processing and administration of teaching plans, teaching, and learning evaluation, staff and students' profile information, curriculum and course allocation to lecturers and its registration by students among other vital activities.

Besides, Aserey & Alshawi (2013) examined a typical case study of tertiary education system, King Abdulaziz University (KAU) at the Kingdom of Saudi Arabia and described the several forms of EMIS at the internal level of the institution. These forms of EMIS includes the University Bid System (UBS), Academic and Staff Services Systems (ASSS), Student Services System (SSS), Administrative Service Systems (ASS) and Other Extra Services Systems

(OESS). Aserey & Alshawi (2013) further submitted that varieties of EMIS are deployed by tertiary education institutions to support their education activities in a bid to provide reliable and relevant information for planning and decision-making.

Meanwhile, Bisaso & Visscher (2005) conducted a survey of tertiary education institutions to investigate the most common functional modules of EMIS and submitted on the findings to include Student Records and Student Assessment, Financial Monitoring and Planning with least common modules being Student Attendance and Library Management. The common modules, however, were found to be mostly used for decision-making by management team.

However, tertiary education institutions use different forms of EMIS, as shown in the Table 2.1 below, for different education task or challenge. These EMIS are developed as custom solution for specific purposes, while a few others are deployed as open-source solutions. For purpose of clarity and contextual understanding, the major forms of purposively developed EMIS that are used in tertiary education system for administrative and academic tasks management are identified and described in the Table 2.1 below.

Table 2.1: Forms of Purposively Developed EMIS in Tertiary Education Systems

<b>Education Tasks</b>	<b>Forms of EMIS</b>	<b>Development</b>
Enrolment and Admission	Online Enrolment and Admission Information System (OEAIS)	Custom
Academic Units Management	School Administration and Information System (SAIS)	Custom
Curriculum Administration	Course Curriculum and Registration Information System (CCRIS)	Custom
Bursary and Finance	Online Payment and Financial Reporting Information System (OPFRIS)	Custom
Teaching and Learning	OpenEMIS, Modular Object-Oriented Development Learning Environment (MOODLE)	Open Source

	Microsoft Team, Blackboard Learning Management Systems	Proprietary
Results and Records	Result and Record Processing Information System (RRPIS)	Open Source
Library Management	Publications and Research Information System (PRIS)	Custom
	Open Automated Library System (OPAL), Evergreen LIS, Koha Integrated Library Information System (LIS)	Open Source
Profile and Roles Management	User Profile and Permissions Management Information System (UPPMIS)	Custom

## 2.4 EMIS in Nigeria Tertiary Education System

The structure of education in Nigeria is captured in the 6th edition of the Nigerian National Policy in Education that was last published in the year 2013. The policy document identified four stages in the Nigerian education system to comprise: Early Child Care and Development that include Creche, Nursery and Kindergarten schools; Basic Education that include primary and junior secondary education schools; Post-basic Education that captures senior secondary and technical education schools; and the Tertiary Education that comprises the Colleges, Enterprise Institutions, Monotechnic, Polytechnics and Universities.

For this research study, the focus is on the tertiary education system. The activities and study programmes of the different categories of tertiary education institutions in Nigeria is regulated and accredited by the respective regulatory agencies:

- i. National Universities Commission (NUC) – For Universities and other degree awarding institutions.

- ii. National Board for Technical Education (NBTE) – For Polytechnics, Monotechnic, Innovation Enterprise Institutions (IEI) and Vocational Enterprise Institutions and other institutions that award National and Higher National Diplomas.
- iii. National Commission for Colleges of Education (NCCE) – For Colleges of Education that award National Certificate for Education (NCE) degree.

The Nigerian tertiary education institutions, with particular focus on the Universities that are regulated by the National University Commission (NUC), have adopted technology tools captured by Olaleye & Oyewole (2016) as computer-based Management Information System (MIS) as standard means of managing key activities in the tertiary education system, especially in areas of data processing for periodic study-programme accreditation. The NUC regulates the University activities by a periodic accreditation of study programmes (Iruonagbe, et al., 2015) to ensure that the quality and standards of teaching and learning facilities in all Nigerian universities or degree-awarding institutions are in line with the national Benchmark on Minimum Academic Standard (BMAS) (Olaleye & Oyewole, 2016).

Often, the accreditation exercise is contingent on data collections on students and staff records through the established unit of the universities on Academic Planning and Quality Assurance (APQA). This has necessitated the need for the NUC to deploy the Nigeria University System Management Portal (NUSMAP) for data collections and processing (Ise, 2014) from the several EMIS that are deployed by universities. The APQA offices in respective universities collect the requisite data, mostly from the several EMIS sources within the institution. Such institutional-wide data, in the format acceptable to NUC, is uploaded to the NUSMAP.

The increasing demand for reliable nation-wide education data by NUC through the NUSMAP has necessitated the need for design standard for EMIS development that could facilitate integration to achieve cross-platform data exchange.

## **2.5 Design Considerations for EMIS Development**

The development of EMIS, like other application development, requires consideration for the design structures and development technologies with focus on platform, programming languages and databases which are systematically structured to be re-usable (2001). It is only appropriate, therefore, to argue that the key design considerations and requirements for the development of EMIS can be described from the perspective that captures its mechanism for handling data, development platforms and design architectures. However, the network

infrastructure that serve the transport channel for exchanging data among various EMIS and the end-users, who interact with the EMIS, are extension of the design consideration and requirements for integrated EMIS development. The interaction among these considerable elements is represented in the Figure 2.4.

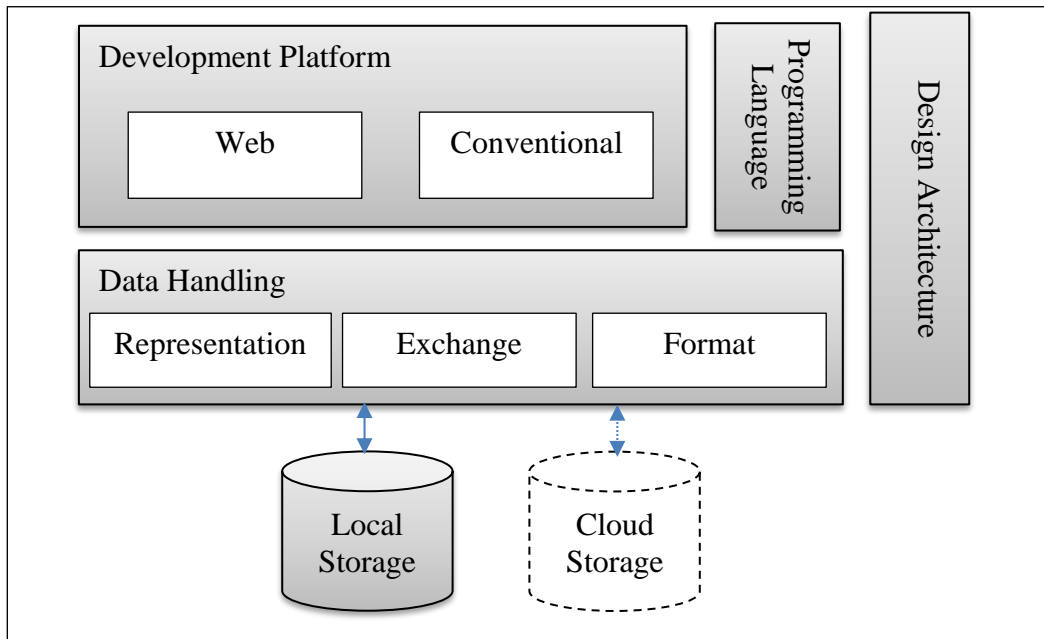

Figure 2.4: Design Considerations for EMIS Development

The foundation of EMIS is built on data that is represented by its data type, forms and model. The design consideration for these data representation and exchange affects the development of integrated EMIS of different platforms and the storage of the data on a local or cloud database infrastructure. Meanwhile, EMIS is developed using a programming language that is appropriate for the development platform base on a design architecture that ease the process of integration of various EMIS to achieve data exchange.

### 2.5.1. Data Representations

The structure of EMIS in the education system suggests that great volume of data, like in the big data model, is involved and form its core component. This data that is being generated and processed from different sources and at different stages of the education activities has different formats and models (Chen, et al., 2013). In the instance where data needs to be exchanged across EMIS, it is only appropriate to ensure a proper description and organisation of the data to aid the understanding of the techniques and technologies of data processing and

manipulation. Thirunarayan and Immaneni (2009) argued that these data can be grouped into three categories:

- i. **Human readable data** - HTML document, plain text and images, among others
- ii. **Machine readable data** - Web Ontology Language (OWL), Resource Description Framework (RDF), Resource Description Framework Schema (RDFS) documents, among others, and
- iii. Data that can be consumed by human and machine alike - HTML/XHTML documents.

The data concept of the EMIS can further be described and represented within the context of its types, forms and models:

- i. **Data Types:** In performing and delivering on its function, EMIS is made to manipulate different data objects, which can be classified or grouped by certain characteristics. The data can be grouped in the formats of document (text), media (images, audio, and video), characters (alphabets and numbers), List (items) and Options (highlights). However, there are built-in and user-defined data types that are supported by different programming languages that are used for the development of EMIS. The built-in data types are used to represent the format for storing the data at the physical layer of the data storage system. Meanwhile, user-defined data types are extensions in the programming language or development platform used by application developers to define special data type to enhance the logic and capability of EMIS development.
- ii. **Forms of Data:** This represents the structural organisation or categorisation of data relative to how they can be searched, accessed, or retrieved from the storage system. Meanwhile, EMIS can be described relative to the Big Data concept on the strength of its capacity to generate a huge volume of data from multiple sources with increasing complexity for analysing such data to assist in decision making. On the strength of variety and forms, EMIS data can be categorised thus:
  - **Structured:** This refers to data representation with a well-defined data model and semantic. Structured data can be easily processed, represented in a tabular form, stored in a relational database (using a Relational Database Management Systems – RDBMS) and retrieved or manipulated by a Structured Query Language (SQL).
  - **Semi-structured:** This refers to data representation that has no definite schema that can easily be stored in a relational database. Its data model is self-describing

as such that each data object describes its own data model. Storage and retrieval of semi-structured data representation can be easily achieved with the technology support provided by the Extensible Markup Language (XML) and Java Script Object Notation (JSON).

- **Unstructured:** This refers to a data representation that can neither be organised in relational form nor have pre-defined data model. Technologies like the Data Mining, Natural Language Processing (NLP) and Text Analytics are used to manage the unstructured data representation. However, non-SQL (NoSQL) database have evolved as a mechanism to manage the storage and retrieval of unstructured data.

However, Maier, Hädrich, & Peinl (2009) argued that there is no difference among these data representations, except for technical presentation, as all data can be manipulated and stored in the database. The author argued further that, while structured data can be easily manipulated with SQL, the semi-structure data can as well be easily manipulated with XML and JSON, among other data serialisation formats. Meanwhile, the unstructured data are difficult to analyse (Sagiroglu & Sinanc, 2013).

iii. **Data Model:** This represents the standard layered organisation of data elements and how they relate with one another. The data model is a critical stage in the preparation of EMIS for handling data storage and retrieval. In relation to the American National Standards Institute (ANSI) three-level architecture, the data model for EMIS can be argued and described along the perspective of these three levels:

- **Conceptual:** This is the top level of the data model and describes the important data entities and their relationships. The conceptual layer expresses the core concept, rules, and definitions of the data objects. For instance, the information requirements of EMIS, reflecting on the key education activities as entity and the processes as relationship, is represented with an Entity-Relationship Diagram, as a tool, at the conceptual level of the EMIS Data Model.
- **Logical:** This is the middle layer of the data model and expands the information provided in the conceptual model layer. This is done by providing further information on the attributes of the data entities and their relationships. The logical level is involved in the representation of the key entities and attributes in the information requirement for the design of EMIS as tables of rows and columns in the relational database system.

- **Physical:** This is the lowest abstraction level of the data model and describe the technical details regarding the data storage. This involves the specification of the data types and structures of the attributes of the data entity in the EMIS relational database.

It is important to note and argue that an assessment of the data model is critical to ensuring the design of a well-structured database for EMIS that can ease the process of achieving data exchange in EMIS.

### 2.5.2. Data Exchange Mechanism

Relevant to the design of integrated EMIS is the mechanism for exchanging data among EMIS that are used in the education system. The difference in the operating platforms, programming languages and underlying data models of the several EMIS that communicate, within and outside the education system, pose challenges to data exchange (Sayed, et al., 2016). The resultant effect of these challenges is manifested in data reliability and consistency across the different isolated systems. For instance, the records of students in the EMIS for managing the admission or enrolment may not be consistent with the profile of students in the institution because of the failure of data exchange mechanism.

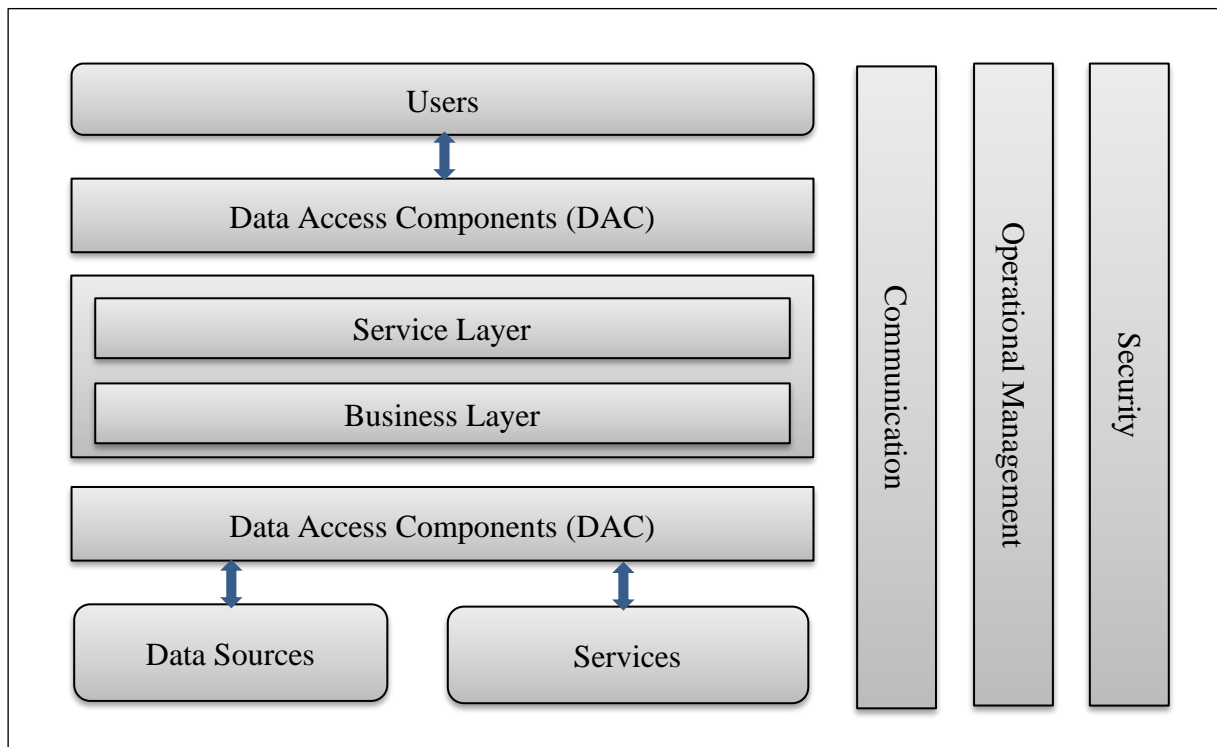

Figure 2.5: Data Exchange Mechanism

source: (Mikreyyohannes & Omer, 2013)



Resolving the inherent data exchange challenge requires a deliberate technical approach. Mikreyyohannes and Omer (2013) argued for the use of Web Services approach to create an architecture, as shown in Figure 2.5, that is based on three-layer service applications: the presentation layer that delivers the user friendly interface with the window form or browser; the business layer that handles the applications' business logic and functionality; and the data layer that provides access to the data sources. In this approach, the functionalities of the application are exposed as a service that can serve as an end point for other application to access local data.

Meanwhile, Al-Yaseen, Othmana and Nazri (2016) argued for the use of Multi-Agent Service using the Agent Communication Language (ACL) in the Java Agent Development Framework to achieve data exchange among agents that run in different platforms using three methods: exchanging data as an object that is embedded within the ACL; exchange data by creating new agent with the new message embedded; or exchange data as an object using the proxy agent controller of the receiving platform. The author concluded on the greater efficiency of this approach compared to the use of socket class in JAVA that is non-agent based and less secured.

### **2.5.3. Serialisation Formats and Standards**

Exchanging data across different EMIS requires the transformation of the format of the data objects that are in the source EMIS to a converted format that is acceptable to the target EMIS (Sayed, et al., 2016). This concept is regarded as serialisation, which is the process of transforming an object state into a stream (Sumaray & Makki, 2012) of data format that can be transmitted through a communication channel for storage in memory (Eriksson & Hallberg, 2011; Surbhi & Chawla, 2013). Deserialization, is therefore, a process of recompiling the stream of data into its original data object state at the receiving end. The process of data exchange to improve interoperability in EMIS (Sayed, et al., 2016) involves data serialisation using the standard technologies like XML, JSON, YAML, Binary Encoding, among others. This has made the selection of appropriate serialisation format an important choice to make (Sumaray & Makki, 2012). However, the JSON and XML are two widely acceptable serialisation formats (Wang, 2011; Sumaray & Makki, 2012).

Though, serialisation is supported by many object-oriented programming languages like PHP, Python, Ruby, Microsoft .NET Framework, JAVA (Eriksson & Hallberg, 2011), there is literature on the comparison between the XML and JSON, being the common standard serialisation formats, to justify the preference of one over the other. However, the fact has

remained that the two standard serialisation formats have similar functions but are used in different context (Wang, 2011) and can effectively handle serialisation. These two common serialisation formats are discussed thus:

### A. Extensible Mark-up Language (XML)

The Extensible Mark-up Language (XML) is such a mark-up language like the HyperText Mark-up Language (HTML) but with scalability and freedom for developers to define appropriate tags that can be used to enclose the data elements for transmission across different platforms (Haq, et al., 2015). Thus, XML is a flexible standard and natural language for resolving the challenge of data exchange in the integration of several EMIS (Mikreyyohannes & Omer, 2013).

The XML data structure is defined by its specifications in the Document Type Definition (DTD), which requires that every data or document in the XML elements are stored in closed labelled tags that has optional extension for attributes. During transmission for data exchange, the XML parser scan through the tags to recompile the XML object. Because the XML label tags are user-defined, there is the need for an agreement to the tag definitions in the DTD by sending and receiving applications to ensure a successful data exchange (Haq, et al., 2015). A data structure example of XML object format for representing student profile is provided thus:

**Table 2.1: Sample XML for Representing Student Profile**

```
1 <StudentProfile>
2   <Student>
3     <Name id = '20100204001'>Ademola Adenubi </Name>
4     <Programme>Computer Science </Programme>
5     <EntryYear mode='UTME'>2018 </EntryYear>
6   </Student>
7   <Student>
8     <Name id = '20100204002'>Olubunmi Mariam </Name>
9     <Programme>Statistics </Programme>
10    <EntryYear mode='DE'>2017 </EntryYear>
11  </Student>
12 </StudentProfile>
```

In the XML format example shown in Table 2.1 above, the label is the user-defined name that is in the angular bracket (tag). Each statement in the XML object is an element, with group of elements forming an XML object. Labels such as <Name> in lines 3 and 8 and <EntryYear> in lines 5 and 10 have extension with attributes 'id' and 'mode' respectively. It is important to

note that XML naming is case-sensitive, and its objects are analysed as Document Object Modes (DOMs) (Wang, 2011).

In the XML example, the label <Student> is repeated at same level of hierarchy for the two students, whose profile are given in the example. While this is semantically right in the XML data representation, it has the tendency to trigger an index error and data mismatch when it is transmitted to the JSON end for translation. The solution is to convert the two blocks of XML objects (<Student> ... </Student>) as array list in the same level of the JSON object ("Student": [ ... ]).

## B. Java Script Object Notation (JSON)

Java Script Object Notation (JSON) has evolved as a standard for data exchange in web services and it is similar to XML because of its support for hierarchical semi-structured data model (Chasseur, et al., 2013). However, JSON object uses a simple lightweight data serialisation technique that is based on the syntax of JavaScript object initialisation (Haq, et al., 2015). The fact that JSON can be parsed more easily has made it a preferred choice in data exchange format for Web Services (Peng, et al., 2011).

The semantics of JSON allows for two object forms to describe its data structure: the name or value pair and the ordered list of array values (Wang, 2011). The structure of JSON data representation allows another JSON object to be nested, just like in the XML, and this is interpreted as an array of values in most programming languages. On the strength of this JSON array representation during data transmission, Wang (2011) further argued that the difference and challenge in the data transmission to exchange data between XML and JSON as a possible index error will be triggered because JSON objects do not support the use of more than one array index at the same object level. A JSON object representation of the XML representation above is given thus in Table 2.2:

**Table 2.2: Sample JSON for Representing Student Profile**

```
1  {
2    "StudentProfile": {
3      "Student": [
4        {
5          "Name": {
6            "id": "20100204001",
7            "name": "Ademola Adenubi "
8          },
9          "Programme": "Computer Science ",
```

```

10     "EntryYear": {
11         "mode": "UTME",
12         "year": "2018 "
13     }
14 },
15 {
16     "Name": {
17         "id": "20100204002",
18         "name": "Olubunmi Mariam "
19     },
20     "Programme": "Statistics ",
21     "EntryYear": {
22         "mode": "DE",
23         "year": "2017 "
24     }
25 }
26 ]
27 }
28 }

```

Meanwhile, Wang (2011) raised argument for the joint application of XML and JSON as standards for data serialisation in Web Services and Asynchronous JavaScript and XML (AJAX). In a scenario that require data transmission among local and third-party applications, the author further argued for an architecture that combine the use of both XML and JSON and put preference for the use of JSON to transmit data within the local applications while the XML is used to transmit data with third-party applications.

**2.5.4. Design Architectures**

A key design consideration for the development of integrated EMIS is its design architecture, which defines the underlying principle and pattern of development. In essence, the structures

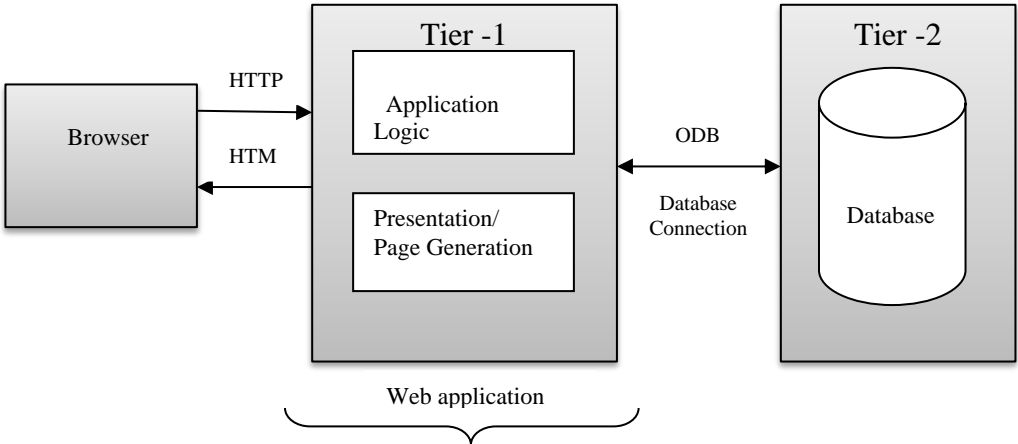

**Figure 2.6: 2-Tier Architecture**

and architectures of EMIS reflects its major characteristic of being a client-server (2-tier) application (Mendes, 2014) with components and functionalities residing on different tiers of the architecture (Casteleyn, et al., 2009). Meanwhile, Mendes (2014) argued that the transition to more than 2-tier architecture is motivated by desire to address the limitations of the 2-tier architecture, as shown in Figure 2.6, which put a huge workload, in terms of bundling the content and its formatting together on the clients (Jazayeri, 2007). To balance the load and ensure the effectiveness of the application, there is the need to separate the logic of data processing, clearly and logically, from the information presentation on the client.

However, in the 3-tier architecture, as shown in Figure 2.7, the EMIS, like other information systems, separates its application functionalities into manageable blocks of tasks: presentation, application logic and database management. The handling of the request for data storage and retrieval in a tiered EMIS application can be implemented with an appropriate programming or scripting language and a backend database storage system. Jazayeri (2007) described the client-side script to be a set of programming codes that runs on the client (browser) and interact with the user (example include AJAX and JavaScript), and the server-side script that process requests on the server and interacts with the database (example includes PERL, PHP, Python and Ruby).

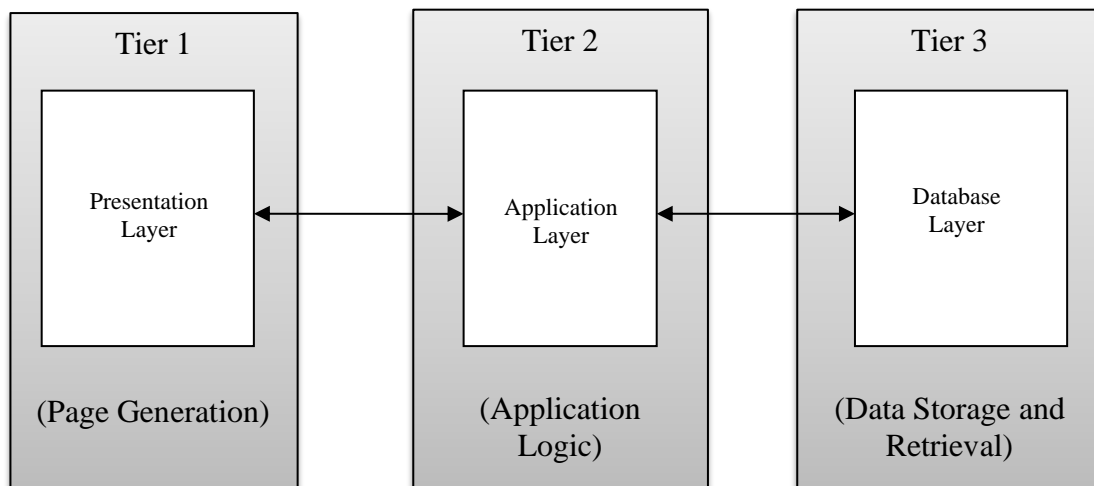

Figure 2.7: 3-Tier Architecture

Meanwhile, the ability of the 3-tier architecture to separate the page generation, application logic and the database into separate logical layers makes it efficient and easier for integrated EMIS to seamlessly exchange data. This also allow application developers to create integrated EMIS that can be easily managed; each tier can be modified without resulting in the overall

change of the EMIS. Thus, improving the potential of the integrated EMIS for scalability and performance.

### 2.5.5. Development Platforms

Another key design consideration for the development of integrated EMIS is the platform and framework on which it is developed. This can be argued from the software engineering perspective to be such that follows the fundamental design principles: abstraction, refinement, and modularity. This can be achieved using the conventional software or web application developments platforms, which are described by (Mendes, 2014) in an argument on an assessment and comparison of the two platforms. The comparison is provided in Table 2.2.

Table 2.2: Comparison of Web Based and Conventional Software platforms

<b>Criteria</b>	<b>Web Application Development Platform</b>	<b>Convention Software Development Platform</b>
Application Characteristics	Integrates numerous distinct components; support distributed, cross-platform applications	Integrate distinct component; supports single platform
Technologies	Scripting languages - JavaScript, XML, UML, databases, third party components and middleware	Object-Oriented languages - C++, Java; relational databases and CASE tools
Architectures	2-tier to n-tier	1-tier to 2-tier
Data Structure support	Structured and semi-structured information content	Structured information content

Thus, the design of integrated EMIS can be broadly described based on the development platform to be Web-based or Conventional Software Based application. For instance, EMIS for processing students' results can be developed on conventional software platforms like the Microsoft Excel Macro using the Microsoft Visual Basic programming language, while another EMIS for managing student profile can be developed with the Microsoft .Net platform using the C++ programming language. Meanwhile, an EMIS for course selection and registration can be developed as web-based application using any of the scripting languages: PHP, JSP, ASP among others. The appropriate choice of the development platform and language is based on

such consideration as the expertise of the developer, the intrinsic characteristics of the platform and the audience or environment where it will be used (Mendes, 2014).

Ali (2013) argued that tertiary EMIS requires a web-based technology for effective communication and integration. The web based EMIS have the capacity to efficiently adapt to the changing requirements of tertiary education systems by making the management of information flow across the integrated EMIS in each department to be easy (Duan & Zhang, 2007).

However, there are Rapid Application Development Environment (RADE) as functional platform with technology framework to ease and speed up the development process (Sasmito & Wiyono, 2017) of web based integrated EMIS. These RADE include Visual Studio, NetBeans, Eclipse with functional framework and extensions to support different programming languages and gives developers the latitude to explore the class libraries to develop different applications (Kralev & Kraleva, 2017). Meanwhile, there is growing popularity of the Laravel and Symphony as open-source RADE with framework that support PHP programming that supports demonstration of web applications with re-usable libraries of codes (Laaziri, et al., 2019).

## 2.6 Benefits and Limitations of EMIS

The tertiary education system has an open system of general administration where every functional department exhibits respective information requirement with information

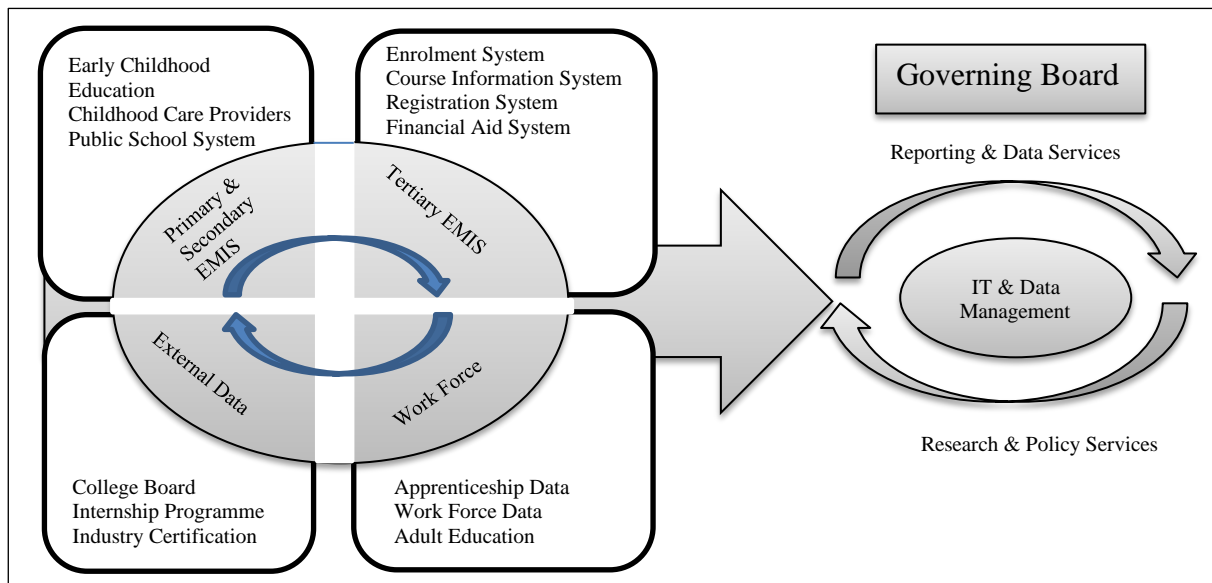

Figure 2.8: Potential of Integrated EMIS

connections among them diversified (Duan & Zhang, 2007). This puts restrictions on the capacity to share or exchange information. Indrayani (2013) cited Hanna (2003) in an argument that the effective use of Information and Communication Technologies (ICTs) in managing tertiary education system is hinged on a productive education management information system. A productive EMIS changes the tools and processes used in exchanging information (Kurt D, 2001) and remove the border of sharing information (Kaya & Dogu, 2013). Thus, EMIS is critical to the efficient and effective management of education system.

Abdul-Hamid (2014) in a World Bank Group report described the potential of EMIS with a framework of integrated EMIS that captures its possible outcome when effectively implemented, integrated, and sustained. The framework, presented in Figure 2.8, demonstrates the longitudinal data flow from different sources of EMIS: from the Primary and Secondary School EMIS to the Tertiary School EMIS, then integrating to the Work Force and External data sources. The argument in the framework established the critical benefit of EMIS, even beyond the education system.

### **2.6.1. Advantages and Benefits of EMIS**

The following arguments represent some of the key advantages and benefits of EMIS to the education system, particularly the tertiary education sector like the University. Thus, EMIS:

- i. Promotes the system of collecting, storing, classifying, processing, maintaining, disseminating and use of shared information within the education systems.
- ii. Allows accurate, timely and reliable data to be accessible and available to education stakeholders for planning and decision making.
- iii. Enhances the productivity and performance of key staff members of the institutions.
- iv. Promotes transparency and accountability through a platform that actively engages all stakeholders in the education system.
- v. Provides for an effective and efficient management of the education system at relatively low operational cost, in the long run.

However, the key benefits and advantages of EMIS are summarised by Damin, Kadry, & Hamed (2014) while citing Hua & Herstein (2003) to include “*timely and reliable production of data and information, data integration and data sharing among various EMIS offices and efficient use of data and information for policy decision*”.



### 2.6.2. Challenges and Limitations of EMIS

While it is argued that EMIS have great importance in the administration of an education system, there are considerable challenges and limitations to its key objective, which has *“shifted from focusing on access, expansion, maintenance and control to quality, development, efficiency, effectiveness, equity and performance”* of information (Damin, et al., 2014). Kurt (2001), however, argued that these challenges have technical elements that are primarily concerned with the use of information. The challenges are summarised by Sajjad & Awais (2010) and Damin, Kadry, & Hamed (2014) as thus:

- i. Lack of adequate information for sharing and exchange
- ii. Managing the inherent complex issues of scalability, security and robustness of the database that forms the backend of the integrated systems.
- iii. Financial requirements for managing the technical infrastructure in support of EMIS.
- iv. The need for expertise with requisite technical skills to manage EMIS

Abdul-Hamid (2014) summarised the limitations of EMIS with an argument that the “use of an EMIS could be limited due to incompatibility with existing systems, customization of new systems, the capacity of EMIS staff, limited financial resources, or limited government commitment”. Meanwhile, Wang & Shi (2012) argued for the limitations of EMIS from the technical point of view to include data redundancy, accuracy and normalisation deficiency that arise when several EMIS are integrated together to broaden the scope of EMIS in tertiary education system.

However, the degrees to which these challenges and limitations affect the use of EMIS in education systems differ between developed and developing country. Sajjad & Awais (2010) argued that the developing, as against the developed, countries are performing poorly in the integration of their EMIS to effectively manage data for EMIS activities at all levels.

Beyond the argument on the description of EMIS as an information system that is used in education system, there is the need to examine the related issues of designing and developing EMIS as an integrated system to achieve Its full potential in education. This requires an understanding of the underlying technologies that can assist to resolve the challenge of integrating new EMIS to existing systems and evolving a standard design framework for the development of integrated EMIS that exchange data seamlessly.

## 2.7 Closing Remark

This chapter raised discussions around EMIS with respect to its description as an education support system for connecting people, process, and technology together. On the strength of this background, the first research question is answered:

### **What are EMIS and their challenges in tertiary education system?**

In tertiary education system with layered structure of faculties and departments, EMIS is used to manage the flow of information within and across the internal and external levels; the internal level reflects the tertiary education structure and external level connects the tertiary education with the external agencies or organisations. The internal level is of concern in describing the various EMIS with three (3) identified categorisation: Higher Education Student Information System (HESIS), Internal Management Information System (IMIS) and Open-Source Information System (OSIS). However, the chapter raised argument that tertiary education institutions deploy several forms of EMIS for each education task or challenge such as Enrolment and Admission, Academic Units Management, Curriculum Administration, Bursary and Finance, Teaching and Learning, Results and Records, Profile and Roles Management. These EMIS are either custom built for specific purposes or open-source solutions for adaptation to meet specific education task.

The chapter further examined the related issues on the design considerations for the development of integrated EMIS within the context of its design architectures, development platforms, data representations, mechanism for data exchange and the serialisation formats and standards. Arguments were raised for the consideration of 3-tiered architectural design using XML and JSON as the two common technology standards for serialisation and data exchange, in the development of EMIS on a web platform using appropriate scripting language.

The chapter concluded on the key benefits and limitations of EMIS in tertiary education system. The benefit is hinged on the timely availability of reliable shared data for policy and decision-making in the education system. Meanwhile, the key limitation is in the inherent incompatibility challenge of integrated EMIS due to the absence of a standard design framework for the development of integrated EMIS that can interoperate to seamlessly share and exchange data.

## CHAPTER 3 : EMIS INTEGRATION

This chapter underscores the technical concept of EMIS integration. The objective is to review literature and examine the approaches, technologies, and frameworks for EMIS integration. Thus, assisting in answering the second research question:

- ii. **What approaches, technologies and frameworks are currently used for the development of integrated EMIS?**

In attempting to answer the above research questions, the requisite research objectives are addressed in sections as shown in Figure 3.1.

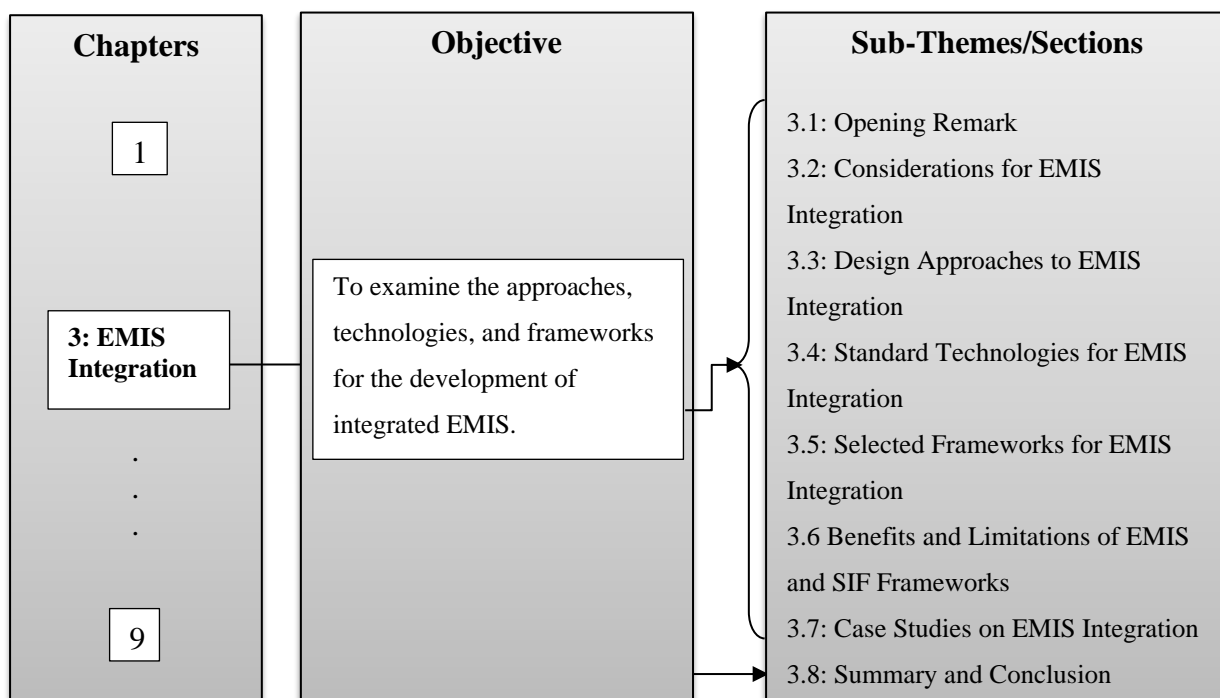

Figure 3.1: Objective Overview of Chapter Three

The arguments that are observed in the review of literature, subject to content and thematic analysis, are articulated in the following eight (8) subthemes.

The Opening Remark subtheme (Section 3.1) examines the basic needs, techniques, and challenges for the integration of various EMIS. The Considerations for EMIS Integration subtheme (Section 3.2) examines the arguments for the focus, purpose, and level of integration. The subtheme on Design Approaches to EMIS Integration (Section 3.3) identifies and discusses the design techniques for achieving integration of several EMIS. The Standard Technologies for EMIS Integration subtheme (Section 3.4) discusses the Web API, Web Services, and the

Semantic Web as technology options for achieving EMIS integration. The subtheme on Frameworks for EMIS Integration (Section 3.5) examines the School Interoperability Framework (SIF) and Education Management Information System Interoperability Framework (EMIF) as existing frameworks for the integration of several EMIS. The subtheme on Benefits and Limitations of SIF and EMIF (Section 3.6) discussed some of the benefits of using the frameworks and raised further arguments on their challenges and limitations. The Case Studies on EMIS Integration (Section 3.7) further reviews the literature for studies on the use of several technologies and approaches to EMIS integration. Meanwhile, the Closing Remark subtheme (Section 3.8) articulates the arguments that are raised in this chapter to answer the requisite research question.

### **3.1 Opening Remark**

The growing demand and requests for interconnection of several systems to access and exchange data has necessitated the need for integration (François, 2009). Therefore, integrating several EMIS is a technical approach of removing communication barrier to enhance the productivity and proficiency of the education system. This is substantiated by Panetto & Cecil (2013) with the argument that enterprise systems integration provides for efficient communication among the systems. Integration, therefore, can be achieved with the provision of data exchange interface or platform.

The goal of integrating several EMIS is to ensure that each system can access shared data through a layer of granted privileges (Panetto & Cecil, 2013). The author argued further that the consideration for application programming interface (API), standard data exchange format and common services for the execution environment are necessary for integration. Thus, integration revolves around services and technologies for handling data exchange across multiple data sources. This is corroborated by Maier, Hädrich, & Peinl (2009) that integration act as a service to ensure exchange of data across data sources, its meta-data that describe its functionality, the ontology that addresses the semantics of bringing data together, and the functions and services that describe the important integration technologies.

For instance, the possible deployment of Central Data Exchange Server (CDES) or an Application Programming Interface (API) can be a technology approach of adding new EMIS to existing systems to effectively achieve integration. The API interface, which can be regarded as a block of programming codes with data parameters that are wrapped in class objects, can

be exposed and consumed by EMIS to exchange data. Such API interface use standardised message format like the Java Script Object Notation (JSON) or Extensible Markup Language (XML) to exchange and process data requests. In the alternative, the use of the CDES considers the development of mobile agents for the transmission of data between the central EMIS server and the other EMIS extensions. Thus, achieving data exchange is through the CDES and the mobile agents.

Meanwhile, there is an inherent complexity of deploying the underlying integration technology to address the incompatibility challenge in adding new EMIS to existing systems at the different levels of the tertiary education system. This has posed a great challenge to EMIS integration that allows data exchange across heterogeneous platforms.

### **3.2 Considerations for EMIS Integration**

In the education system, where several EMIS are deployed to address several education tasks at different levels, integration is a required technology approach of removing communication barriers to allow for the interconnection of the various systems. This complements Section 4.9.1. There is, therefore, the need to clearly define objectives and identify the technical means of achieving integration. This is necessary with considerations for some issues such as focus, purpose and level of integrations.

#### **3.2.1 The Focus of Integration**

Maier, Hadrich & Peinl (2009) cited Merten (2001) with the argument that information processing requires consideration for some dimensions to EMIS integration. These dimensions include consideration for:

- i. **Data objects:** This relates to the data structures, methods, functions, processes, and programs that the integrated applications maintain.
- ii. **Direction of integration:** This can be integration of processes within a service provision (horizontal) or integration across service levels (vertical) or integration with shared services (common data).
- iii. **Scope and Range of Integration:** This relates to the integration of functions at the internal or external levels of integrated EMIS.
- iv. **Degree of Automation:** This considers the level of intervention that is needed to fulfil the functions of the integrated systems.

A holistic view and approach to the focus of EMIS integration is, therefore, appropriate for consideration. The horizontal integration that allows data exchange, with a degree of automation that is triggered by events, across different services within the internal levels of an enterprise system is considered the appropriate integration focus for this study.

### 3.2.2 The Purpose of Integration

With the education system pushing for technical approach to achieving the integration of EMIS, there is the need for the examination of key purpose\ of integration. The technical approach to EMIS integration can be argued, on critical assessment, to be for three (3) key purposes. This is represented in Figure 3.2.

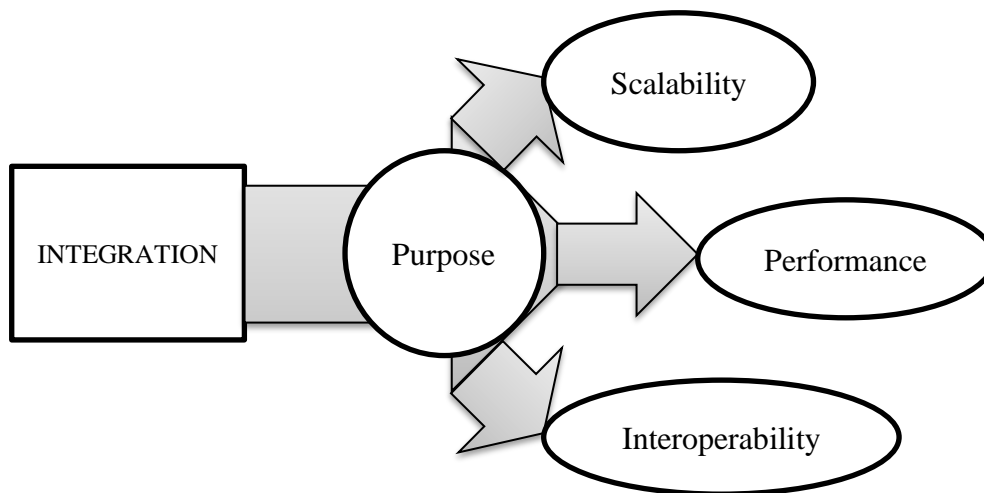

Figure 3.2: The 3 Key Purposes of EMIS Integration

- i. **Scalability:** This involves the need for the integration of several EMIS with the purpose of extending its functionalities and scope of operations. In this regard, scalability can be achieved by upgrading EMIS with new module extensions (horizontal scalability) or by connecting new functional EMIS to existing structure of EMIS (vertical scalability)
- ii. **Performance:** This involves the need for the integration of EMIS with the purpose of enhancing or optimising its functionalities. In this regard, for instance, the performance of EMIS can be optimised by extending access and processing of information from different sources to provide a greater depth of information. Thus, performance can be achieved with scalable EMIS, but scalable EMIS may not address performance purpose.

- iii. **Interoperability:** This involves the need for providing technical standards with the purpose of achieving communication and exchange of data across platforms of different information and communication semantics.

In this research study, integration is focused as technology and methodological approach to achieve interoperability; exchange of data across several EMIS. For an education system, integration of EMIS has the potential to allow for the exchange and sharing of data across several EMIS being used for different purposes. Thus, relative to the direction of integration, EMIS integration can take vertical and horizontal dimensions. For instance, an EMIS that is being used for User Profile Information System (UPIS) can be integrated with the EMIS on Course Curriculum and Registration Information System (CCRIS) to exchange data and obtain information on students' course registrations and performances. Alternatively, the integration could be within an EMIS of multiple functional modules; each module being required to interoperate by exchanging data with one another.

### 3.2.3 The Level of Integration

The main objective of integrating different enterprise application systems, within the context of achieving interoperability, is to ensure that each system can access shared data (Panetto & Cecil, 2013). Integrating EMIS, therefore, requires a depth of understanding of the layers of EMIS structure to determine the level at which the integration can be achieved. The levels of integration in enterprise application, like EMIS, are raised in argument by Tariq & Abrar (2012). These levels are discussed as thus:

- i. **User-Interface Level:** This approach to integration is primitive. It achieves integration at the user interface level. For instance, integration of several EMIS can be achieved with the use of usual menu platform on the application window to access and exchange data across several functional EMIS. The benefit of achieving integration with this approach is defined by its simplicity in synchronising and conveying information across several EMIS with uniform channel at the user interface. Meanwhile, user-interface level integration is a last resort as it becomes difficult to maintain especially when the logic is embedded in the client and there is need for frequent changes to the programming logic (Fenner, 2011). Thus, a functional standardization is required for user-interface level integration (He & Xu, 2014).
- ii. **Application Interface Level:** With this approach, integration is achieved at the level of the Application Programming Interface (API). Each EMIS can expose and

consume API for the purpose of accessing and exchanging data across functional modules. Thus, several EMIS are integrated to share data and logic. Meanwhile, the use of Service Oriented Architecture (SOA) and Enterprise Application Integration (EAI) are two common technology approach for achieving integration at this level. These technology approaches to integration at the API level are discussed in Section 3.4 of this thesis. The benefit of integration at the API level is defined by the availability of standard technologies and re-usable shared services that offers effective means of integration. Thus, the API integration is considered as the best level for EMIS integration owing to its mode of implementation that preserves data integrity as it only invokes the services of other EMIS at the logic layer (Fenner, 2011). However, its complexity of administration, especially when single purpose interfaces are exposed to other EMIS, is a major limitation (Laftsidis, 2000; He & Xu, 2014).

- iii. **Method Level:** This level of EMIS integration requires that processes and methods of functional modules in several EMIS are synchronised and re-used. The methods are instances of a block of programming logic that can be exposed and consumed to process data. This approach requires that methods can be shared and re-used across functional modules of EMIS using standard tool for the programming paradigm. Thus, integration of EMIS can be achieved by accessing and re-using methods of other EMIS to exchange data. However, there is a challenge with the method level integration owing to the difference in the requirements and logics of each EMIS (Tariq & Abrar, 2012). Thus, the re-use of methods is limited due to the lack of consistent and standard technology, architecture and central control (Laftsidis, 2000).
- iv. **Data Level:** Integration at this level requires the process or technology of exchanging data at the database level of EMIS. This is achieved by extracting, manipulating and storing data in one database and granting access to other EMIS, with required access rights, to manipulate the data and returning the updated copy to the storage location. This approach to EMIS integration ensures that a single source of common data is available for several EMIS to share. The key benefit of this approach to EMIS integration at data level is its capacity to reduce data redundancy and ensuring data consistency. It is crucial, however, to note the argument of Hua & Herstein (2003) that the *“key to data integration is the process of standardizing data structures, types, formats, and coding schemes, as well as creating institutional agreements to share and mine data for policy-making purposes, including monitoring the present, evaluating the past, and projecting the future needs of the education system”*. While data level



integration is best with availability of standards on syntax for data exchange, there is still the challenge with semantics of recognising and validating exchanged data (Vujasinovic & Marjanovic, 2006) with additional requirements for developers to continually review the underlying data schema for any changes to update their applications (He & Xu, 2014).

Table 3.1: Comparison of the Levels of Integration

<b>Comparative Factors</b>	<b>User-Interface Level</b>	<b>Application Interface Level</b>	<b>Method level</b>	<b>Data level</b>
Shared Interface	Yes	Yes	No	No
Shared Data	No	No	No	Yes
Shared Services	No	Yes	No	No
Standards/Technology	No	Yes	Yes	No
Administrative Complexity	No	Yes	Yes	Yes
Scalability/Expansion	No	Yes	Yes	Yes

With the arguments that the integration of several EMIS, within the context of interoperability, can be achieved at the User-Interface, Application Interface, Method and Data levels, it is important to note and appreciate the effectiveness of achieving seamless data exchange at the Application Interface level. This argument on the Application Interface level as the most effective level of integration is premised on a cursory appraisal of analysis of comparative factors, as presented in Table 3.1. The comparison shows that integration at the application interface level has greater support for shared services that guarantee data integrity. The integrity of each EMIS data is maintained as each functional module or service is able to manipulate its own data, taking cognisance of its own underlying data model, before sharing the processed data through its interface with other EMIS. This is achieved with standard technologies for data exchange that simplify the complexity of achieving integration of EMIS. This research study, therefore, is focused on the integration of EMIS to achieve interoperability at the application interface level.

### **3.3 Design Approaches to EMIS Integration**

With increasing need to integrate EMIS of different platforms, choosing the right level and approach to integration is such a great decision to make considering the proliferation and

rapidly changing technology choices and options (Péči & Važan, 2014). There are arrays of technology approaches to achieve integration, which include the use of Business Process Management (BPM), Enterprise Service Bus (ESB), Enterprise Application Integration (EAI), Service Oriented Architecture (SOA), among others. However, the use of EAI and SOA are considered as two possible design paradigms for EMIS integration (Jakimoski, 2016). This argument is premised on the submission by Mohammad & Goknur (2010) that the EAI and SOA support for standard technologies: HyperText Transfer Protocol (HTTP) and Extensible Markup Language (XML), is responsible for their use in cross-application development and integration. The two design approaches are discussed thus:

### **3.3.1 Enterprise Application Integration (EAI)**

Enterprise Application Integration (EAI), which can be described as a middleware of technologies and services, is argued by Fazlollahi, Franke, & Ullberg (2012) as an approach to system or application integration. Middleware, providing enhanced support for EAI (Bertino, et al., 2010), is described as a technology stack that provides a platform for information exchange between applications in a distributed environment (Emmersberger & Springer, 2013). Mohammad and Goknur (2010) argued that the whole idea of EAI is about interoperability and synchronisation of information across multiple platforms. This was corroborated by Aserey & Alshawi (2013) while trying to establish an argument for the use and benefit of EAI to higher education institutions, that the main objective of EAI is “to integrate separate applications into one”.

EAI adoption in application integration is architected on two possible paradigms: Direct Point-to-Point and Middleware based integration (Fenner, 2011; Patil, et al., 2014; Jakimoski, 2016). However, in the argument of Tariq & Abrar (2012) EAI architecture can be point-to-point, bus or hub topologies depending on the approach for implementation. Irrespective of the architecture, nevertheless, the focus is to adopt EAI as a strategic approach to achieving data and process integration (Fazlollahi, et al., 2012).

The Direct Point-to-Point architecture of the EAI, as shown in Figure 3.3, achieve integration by providing separate end-to-end connections for each EMIS to integrate with others. With relatively few EMIS in the integration loop, this approach is simplistic and effective with good communication speed between the two integrated EMIS but get complex with increasing number of EMIS to integrate (Patil, et al., 2014). While this is a primitive idea and approach to integration (Jakimoski, 2016), its tight coupling and increasing integration points, with

attendant complexity, are major limitation in scenarios where additional EMIS are to be integrated with existing ones (Fenner, 2011).

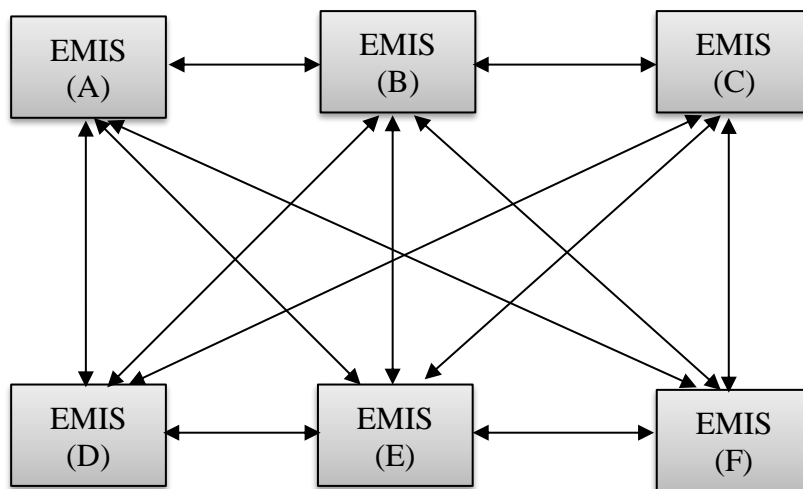

Figure 3.3: Direct Point-to-Point EAI Architecture

Meanwhile, the Middleware based EAI, as shown in Figure 3.4, uses a centralised middleware messaging system that connects and routes messages across multiple integrated applications through a generic interface (Patil, et al., 2014; Jakimoski, 2016). This reduces the integration points to the number of systems to be integrated and thus makes integration of heterogeneous applications feasible and simpler. However, there is a complexity configuring the middleware platform and adapting the systems to connect to the middleware interface (Fenner, 2011).

However, Güner (2005) as cited by Mohammad & Goknur (2010) made suggestions on some

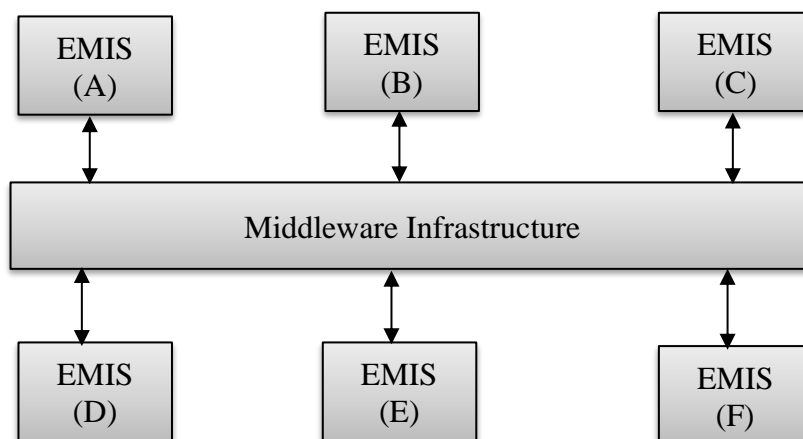

Figure 3.4: Middleware based EAI Architecture

technologies that are used in EAI to include Java Message Service (JMS), Remote Method

Invocation (RMI), Component Object Model (COM), Distributed Object Model (DCOM), Common Object Request Broker Architecture (CORBA), and Web Services. There is therefore the need to integrate these technologies (Aserey & Alshawi, 2013) when considered in different deployment scenarios that have different EMIS using any of these technologies.

With the EAI providing flexible and convenient mechanism for processing integration of systems with heterogenous data sources and platforms (Xu, 2011), educational institutions using several EMIS can share services and interconnect several systems to improve security, privacy and standards of sharing data (Aserey & Alshawi, 2013). However, the relative higher cost and time of development, complexity of deployment and administration, and high skill requirement to manage the EAI architecture to reflect the changing requirements of integrated systems are identified by (Tariq & Abrar, 2012) as the challenges of EAI.

### **3.3.2 Service-Oriented Architecture (SOA)**

The SOA paradigm was evolving (Nicolás, et al., 2007), and its popularity has grown in both academia and industry (Yang & Joy, 2008). The survey conducted by Geric (2010) also established a positive future trend for SOA adoption.

There is no generally acceptable definition for SOA (MacLenna & Belle, 2014) as different researchers have looked at SOA from three different perspectives. From a business perspective, SOA is seen as a set of services; from an architectural perspective, SOA is a set of architectural principles, pattern and criteria; and from an implementation perspective, SOA is a complete programming model with standard, tools and technologies (IMS Global Learning Consortium, 2009).

In this research study context, SOA is seen in the perspective of an architectural design, corroborating the argument of Pedrinaci, Domingue, & Sheth (2011), which has “a flexible set of design principles used during the phases of systems development and integration” (Kaur, 2011).

Meanwhile, the key principle of SOA is a ‘Service’ (Dongdai, et al., 2010) in which case the functional parts of EMIS are wrapped up as service, which is described as a self-contained processes (Papazoglou & Dubray, 2004) and a re-usable component in business process (Chang & Hsiao, 2011) that can be shared and configured through standardised service interface (Dongdai, et al., 2010).

It is pertinent to note the argument of Kaur (2011) that SOA extends beyond the view of services from a technology perspective, but also involves the policies and practices that guide the way services are provided and consumed. Though there is limited academic research on SOA adoption (Geric, 2010; Lohe & Legner, 2010; MacLenna & Belle, 2014), it is widely used by organisations as an effective architecture for integrating information systems (Vukmanovic & Kalpic, 2012).

As SOA becomes relevant in an education system, education institutions have to redefine their processes and the design architecture for the development of their EMIS to make it easier for several EMIS to integrate. IMS Global Learning Consortium (2009) argued that the starting point for the use of SOA in achieving integration is for education institutions to adapt the EMIS to expose their 'Information' as a 'Service' by creating a standard information format to make information available and accessible to all applications within the institution. However, the IMS Global Learning Consortium (2009) argued further, that the process of exposing information as service is easier for new services but may be complex to get legacy applications to expose their business capabilities.

Services in the SOA paradigm are regarded as "self-contained processes – deployed over standard middleware platforms, e.g., J2EE – that can be described, published, located and invoked over a network" (Papazoglou & Dubray, 2004). In essence, services are better described by their functions and characteristics of being interoperable, stateless, loosely coupled, flexible, re-usable, providing functionalities to systems and distributable over network as argued by (Yang & Joy, 2008; Chang & Hsiao, 2011). However, Yang & Joy (2008) argued further that a service can be described as well-defined when it satisfies all the aforementioned characteristics.

While it can be said that the main benefit of SOA is its ability to build interoperable application by integrating loosely coupled services, Kumar, Sujatha, & Kumar (2013) established the following arguments, which are considerably related to implementation, as drawback to SOA:

- Poor response time for processes
- Challenges with testing and absence of service level for critical function
- Non-compliance with regulations by industry and government
- Breach of security and poor service management

Also, Wilde, et al. (2013), argued that achieving integration with SOA brings about increased complexity and certain degree of loss of control. This argument is premised on the observation that the characteristic of SOA that provides support for loose coupling of services allows for a variety of components with different technologies on data handling to be integrated together. Thus, maintaining SOA will require an understanding of the changing nature and improvement in the different technologies of services that are coupled together. Wilde, et al. (2013) posited further that there is the need for the creation of support tool that will allow SOA to adapt just as the applications also adapt.

Table 3.2: Comparing SOA and EAI

<b>Evaluation Parameters</b>	<b>SOA</b>	<b>EAI</b>
Maintenance/Administration	Low	High
Complexity of Implementation	High	High
Scalability	High	Low
Platform Dependency	Low	High
Standard Technology Support	High	High
Re-Usability	High	Low
Programming Support/Paradigm	High	Low
Security	Low	High
Coupling	Loose	Tight

The information provided in Table 3.2 above is to compare the two possible integration techniques: SOA and EAI against some evaluation parameters that are relevant to this study. This is to examine the appropriate means of integrating the different EMIS that are used in Education Institutions.

As can be observed in Table 3.2, there is a high complexity in the implementation of SOA and EAI. However, the two techniques have high support for standard technologies to be adequate for applications and systems integration. But the relatively low support of EAI for scalability, platform dependency, re-usability, maintenance, and programming paradigm makes it inadequate for use in integrating several EMIS that are used in education institutions. Thus, SOA is a preferred technology approach for the integration of EMIS, especially for its high scalability level that allows new EMIS to be integrated to existing systems. However, the high

complexity of administration of the SOA requires technical refinement to simplify its design and deployment for wider acceptability in the education system.

### 3.4 Standard Technologies for EMIS Integration

The integration of EMIS that eases communication in the most effective way (Panetto & Cecil, 2013) is expected to allow each EMIS to “function independently and in cooperation with existing systems” (Jain, et al., 2008). This is, however, premised on the use of appropriate standards that ease the associated complexity in the underlying integration technologies. Such technology standards include the use of Web Services, Web API and Semantic Web for achieving the integration of EMIS that are used at different levels of the tertiary education system.

#### 3.4.1 Web Services

While it is argued that the concept of SOA is a design approach to integrate different applications that use multiple implementation platforms (Kaur, 2011), its implementation in distributed environment is mostly achieved through Web Services (Sahin & Gumusay, 2008; Bloebaum & Lund, 2012; Kumar, et al., 2013). Achieving integration with SOA is in consideration with Web Services (WS), which is gained through the standard XML, or other serialisation formats, that defines the interactions among the components, operations, and protocols in SOA. This is strengthened by the argument of (Chang & Hsiao, 2011) that the capability for cross-platform and expandability characteristics of the XML makes it possible for WS to interface with heterogeneous databases with different data format and architectures.

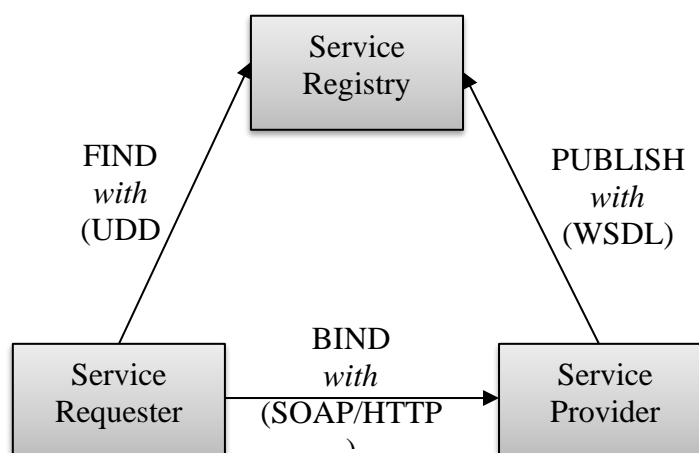

Figure 3.5: Web Service Components, Operations and Protocols Interactions

The Web Service model, as shown in Figure 3.5, has three components: Service Provider, Service Registry, and Service Requester; three operations in web service: publish, find, and

bind; and three XML based standard protocols: WSDL, UDDI and SOAP (Sahin & Gumusay, 2008; Dongdai, et al., 2010; Kaur, 2011). The interaction between the service components, operations and protocols can be viewed with a scenario where the Service Provider publishes services to the Service Registry using the WSDL; the Service Requester then finds the published service by performing service discovery operation on the service registry using the UDDI protocol; once the service is discovered, the Service Requester then bind and invoke the appropriate service from the Service Provider using the SOAP over HTTP.

However, there are other styles of software architectures that are alternative to the use of SOAP, which include the Extensible Mark-up Language-Remote Procedure Call (XML-RPC) and Representational State Transfer (REST) among others (Ploscar, 2012; Sayed, et al., 2016). While SOAP is a traditional standard based web service technology, conceptually complex with a steeper learning curve and relatively “heavy-weight”, REST lacks standard support for security and unusable in a distributed computing environment (Castillo, et al., 2011).

Meanwhile, the XML-RPC requests are stateless, synchronous and its use of HTTP protocol to transport XML data makes it less secured and relatively heavier than the XML (Ploscar, 2012). In the same vein, the Web Service Inspection Language (WSIL) is an alternative standard to the UDDI technology (Oracle, 2014; Verborgh, et al., 2013). It is promoted by IBM and Microsoft as a complement, since WSIL is designed to focus on distributed service discovery (IBM, 2013).

The WS being an implementation standard for the SOA (Geric, 2010; Pedrinaci, et al., 2011) defines interfaces for each service in terms of protocol and functionality, as presented in Figure 3.5. The interface describes the service functionality using the open standard technologies provided in the WS (Kaur, 2011). Thus, systems that are developed on heterogeneous platforms can be easily integrated (Chang & Hsiao, 2011). Meanwhile, Stephen, Blue, Irene, Ben, & April (2005) argued that WS is beyond being an integration technology for achieving interoperability but also a technology means of describing, publishing, locating, and invoking web services.

Sahin & Gumusay (2008) however argued that the concept of the service interface makes WS to be loosely coupled, providing support for applications that support XML messaging protocol to communicate regardless of the difference in their platforms and programming languages. However, achieving integration with WS requires complex technology (Wilde, et al., 2013)



and is limited to applications that can be integrated with service interfaces, which can be configured to support XML messaging protocols.

### **3.4.2 Semantic Web Services**

In addition to the Web Service (WS) as a technology for achieving integration of disparate systems, Semantic Web (SW) also achieves the same objective (Wilkinson, et al., 2011). Meanwhile, Staab et al. (2014) argued that the SW has emerged has a new way of dealing with data, allowing data to be shared and re-used across platforms. This is possible with the approach of the SW in presenting data in a format that makes it easier to be described and read by machines. In essence, the SW “creates an environment in which content can be well defined in order to make it more accessible to computer software agents” (Carapina, et al., 2013). Thus, SW addresses the limitation of the WS by extending the frontier of data description beyond its structure and syntax that is defined in the WSDL to addressing the meaning and semantics of data that is being exchanged.

The Semantic Web Services (SWS), therefore, is a realisation of the vision of the Semantic Web (Berners-Lee, et al., 2006) and a technology extension of the Web Service (WS) (Mahmoud, et al., 2016). It has the main characteristic of using languages with well-defined semantics such as Resource Description Framework (RDF), Web Ontology Language (OWL) and Web Service Modelling Language (WSML) among others (Pedrinaci, et al., 2011) to represent and describe information that can be easily found, shared and integrated (Khamparia & Pandey, 2013). In essence, SWS can be argued as a technology standard with provision for conceptual model and languages that explicitly and formally describe the semantic and behaviour of relevant data that are encoded in the service description language in a bid to automate the process of discovery, invocation, composition and execution of web services (Kang & Park, 2013).

Relative to the same integration architecture of the WS, the SWS enhances the discovery system to make provision for better information retrieval and integration of heterogeneous information systems. A service requester sends a query to the service registry through the discovery engine of the SWS. The discovery process involves keyword search for a list of services that matches the identified information requirements of the requester’s query (Bitar, et al., 2014). From the list of returned requisite services, the service requester can make a selection of service that is suitable for the particular task (Khamparia & Pandey, 2013). This is

then delivered by the service provider with the exchanged data described in a semantic mark-up with three parts: service profile part that described the functions of the service; the process model part that described the operations and how to use the service; and the grounding part that described the specifications for the message format and communication protocol (Kang & Park, 2013). Thus, SWS integrates disparate systems and achieve data exchange through an enhanced discovery system that support meaningful semantic description, discovery, and invocation of data.

The technology of the SWS allows enterprise application developers to explore the standards in the semantic data to process or exchange data across different sources or services without any loss of meaning. This is achieved with the ability of the SWS to address the difficulty of interpreting and comprehending XML messaging, which stressed the syntax and not semantic, by providing a declarative and ontological framework that describe services, messages and concept in a format that can facilitate logical reasoning (Wanga, et al., 2012).

However, the discovery and selection process in SWS is not automatic but requires manipulations by the application developers to refine the results of query and manually scan the list of returned services for selection of appropriate service (Bitar, et al., 2014). This affects the efficiency of the discovery and selection processes with some elements of delay in discovery and error in selection.

### **3.4.3 Web Services API**

The use of Application Programming Interface (API) for the integration of heterogeneous systems is gaining prominence in modern-day computing with its systematic approach of providing an extensible platform for integrating new services into existing systems (Espinha, et al., 2014). In the API context, methods and functions of an application are exposed as a service that can be accessed by other services through a shareable endpoint connection as opposed to the publication of such service as Web Service Description Language (WSDL) file in a registry as used in Web Services. This allows third-parties application to consume and re-use data from other diverse services (Maleshkova, et al., 2010).

Depending on the type of platforms, API can be classified as local or web for desktop or web-based applications respectively. For the considered web platform, the Web Services API or simply Web API (Li, et al., 2014) or RESTful Services (Maleshkova, et al., 2010) make use of the Representational State Transfer (REST) technology approach in providing an integration

interface for other systems to make a single HTTP request for data (Espinha, et al., 2014). Meanwhile, Li, Xiong, Liu, & Zhang (2014) argued on the use of SOAP and XML-RPC as other technology approaches, protocol formats or methods that are applicable in Web API but concluded that most Web API are RESTful services that are provided at either the HTTP level or wrapper libraries level to achieve integration.

The use of the Web API for integration of EMIS to exchange data at the HTTP level is an interaction between the client that is making a HTTP request and the server that is processing the request and sending required data as response message in return.

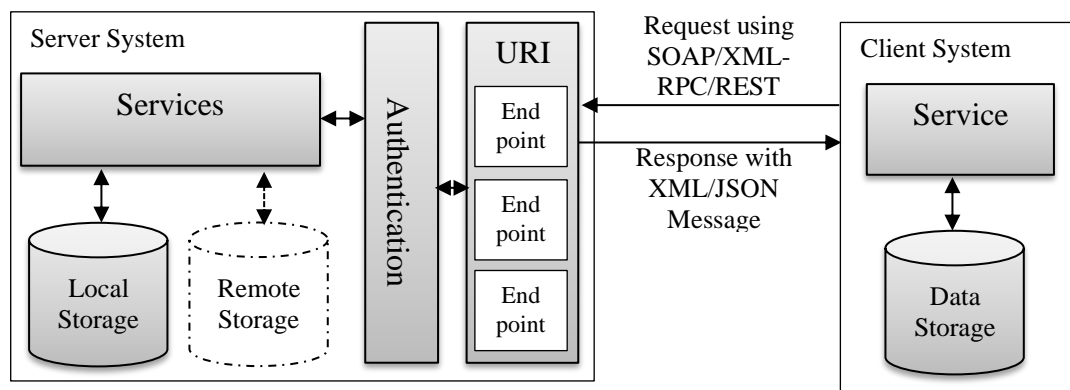

Figure 3.6: Web API Architecture

This interaction is conceptualised and shown in Figure 3.6. The processing of the request involves the execution of the operations, functions and methods that are defined in the requisite services on the server. Services are accessed through the exposed Uniform Resource Identifier (URI), which is its address on the server and its endpoint connection is passed as a parameter value in the HTTP request.

This is to confine the HTTP method to execute only the service operation that is defined by the parameter value (Maleshkova, et al., 2010). To secure the service against unauthorised access, request for consumption of such service may require authentication credentials like an access key or token to be passed along with the HTTP request (Li, et al., 2014). In essence, therefore, the details and architecture of Web API as an integration technology can be described within the context of its HTTP method, Uniform Resource Identifier (URI) invocation and authentication credentials (Maleshkova, et al., 2010).

Besides, the Web API has evolved as an end-to-end service paradigm for the integration of heterogeneous system to exchange data. Its suitability for the web and relative simplicity in

terms of its connections and communication channel for data exchange has remained the basis for the proliferations of Web API in modern day computing (Maleshkova, et al., 2010).

Application developers are at liberty to easily define the structure, functionalities, and documentation of their Web API. This relative freedom of development and use has endeared application developers to the use of Web API for integration.

However, the absence of a common Interface Development Language (IDL) and any semblance of industry standards (Maleshkova, et al., 2010; Espinha, et al., 2014) have limited the use of Web API for integration. In addition to these, application developers are constrained to create profiles to obtain API keys for authentication to access requisite Web API, expend effort at finding and understanding documentation on the use of an API and manually make changes to their client system in response to possible changes in the Web API of the server system

### **3.5 Selected Frameworks for EMIS Integration**

EMIS, as an information system, is used at different levels in the education system with such differences that are better defined by their objectives and functionalities, development platforms and languages, design structures and architectures, among other differentials.

The integration of these diverse EMIS that are used to support academic and administrative services, creates basis for meeting the needs of the education system (Aserey & Alshawi, 2013). Critical to achieving the integration of the several EMIS is the mechanism and standard for data exchange and its efficient management has raised challenges for research study (Al-Yaseen, et al., 2016). To address this challenge, (Dongdai, et al., 2010; Jakimoski, 2016) argued on the proposition of the:

- **School Interoperability Framework (SIF)** as an industry initiative by the SIF Association to activate the process of interoperability and data sharing among educational institutions in the USA and now being adopted by other countries like Canada, UK, Australia, etc, and
- **Education Management Information System Interoperability Framework (EMIF)** as an Educational Information Technology Standardisation by the Ministry of Education of the China Government to aid the integration of different EMIS used by Colleges and Departments of educational institutions.

However, Leal & Queiros (2010) had argued on a survey of several initiatives for the education system that birthed other standard frameworks for the integration of disparate systems that are found in the education institutions, focusing, and addressing issues around such key concepts as:

- **Service Vocabulary:** Description of all possible and available services to a domain
- **Reference Model:** Combination of services for specific education requirements
- **Design Approach:** Specification of all standards for combining services
- **Implementable Artefact:** Implementation (software, process, workflow) of the design

The author further argued on a highlight and survey of other common integration frameworks for education system to include:

- **IEEE Learning Technology System Architecture (LTSA):** The LTSA is a technical standard of practices and guidelines for the development and implementation of education related e-learning technology and it is produced by Learning Standard Committee of the Institute of Electrical and Electronics Engineers (IEEE) Computer Society Standard Activity Board (Isiaka, et al., 2016). The LTSA is designed as a high-level architecture with system interfaces for integrating e-learning systems by making provision for:
  - Processes that describe the system functionalities for managing input and output data.
  - Storage that described the data storage and retrieval system; and
  - Flows that described the inter-connectivity of data across systems.
- **Open Knowledge Initiative (OKI):** The OKI is an extensible and open standard, based on the concept of Open Service Interface Definition (OSID) framework (OKI, 2021) for higher education system that is promoted by the Massachusetts Institute of Technology (MIT). The framework defines standard interfaces for integrating several e-learning systems. The interfaces are used by an e-learning system for exchanging data and accessing functionalities of other e-learning systems. The architecture of the OKI framework has four (4) layers:
  - Educational Application layer that defines the various educational software that is used in an education system
  - Educational Services layer that describes the different services that is exposed by the various education software

- Common Services layer that defines the shared objects such and permissions and authentication services among the services of the various education software
- Institutional Infrastructure layer that describes the infrastructure such as security and database support that is provided by an education institution to support the integration and data exchange communication of the various educational software.
- **IMS Abstract Framework (IAF):** The IAF, as presented on the website of (Consortium, 2021) is an initiative of the Instructional Management System (IMS), which is a global organisation that comprises academic, commercial and government organisations as members with the aim of setting standards and defining architecture for integrating learning systems in education sector. The IAF is a layered abstract representation and specifications of the services and interfaces for integrating various learning systems. The specification of the four (4) layer model of the IAF is in context with the OKI framework.
- **Open University Support Systems (OpenUSS):** The OpenUSS is promoted by the North Rhine-Westphalia State of Germany under the Campus Source Initiative that is targeted specifically for universities to integrate various education software. The architecture of the OpenUSS is a component-oriented framework that specifies extensible Java-based API references that can be called and consumed by the various education software (Leal & Queiros, 2010; OpenUSS, 2021). The two components of the OpenUSS are:
  - Foundation component that describes the core components and functionalities of the education software like the student, faculty, subject, administrator, security among others
  - Extension component that describes the plug-able functionalities that can be installed to extend the functionalities of the foundation components. These components can be lecture, archive, chat, discussion components, among others.
- **e-Framework:** This is a software analysis and design initiative for education and research that was promoted by four (4) partner organisations in different countries: UK-JISC, Australia-DEEWR, Netherlands-SURF and New Zealand-MoE (Kelly, 2006). The e-Framework adopts an approach that defines a service-oriented framework for the development, exposure and re-use of education software services that can be called and

consumed by other education software. The services components of the e-Framework are:

- **Service Genre:** This is a generic specification of the behaviour, rather than function, of services; that is, service genre specifies what a service does and not how it does it.
- **Service Expression:** This specifies the standard and interfaces that is used by a service genre.
- **Service Usage Model:** This is a model specification of the requirements, needs, workflow, process, and policies for the e-Framework.

For this research study, the EMIF and SIF are further reviewed based on their broader approach to integration of EMIS of different platforms and languages.

### **3.5.1 School Interoperability Framework (SIF)**

The School Interoperability Framework (SIF) is an industry initiative and open standard specification supported and promoted by the SIF Association, which is now known as Access for Learning Community (A4L). The framework defines the “architecture requirements and communication protocols for software components and the interfaces between them” (Access 4 Learning Community, 2018).

Thus, the SIF serves as standard guide and rules for integrating and sharing data among different solutions that are used in educational institutions, specifically the kindergarten up to the Grade-12 schools (Leal & Queiros, 2010; Jakimoski, 2016). It however does not specify requirements for any hardware, software, or middleware compliance for developing SIF-enable applications (Access 4 Learning Community, 2018). The descriptive entities in the SIF requirements relate primarily to the elementary up to the high school level.

Since the year 2000 when it was first released, the SIF has been reviewed severally for newer versions that introduce new functionalities and deprecate unused functionalities in older versions. Up to its latest release, Access 4 Learning Community (2018) argued that every version of the SIF specification has consistently focused on two key components:

- **Data Model:** Specifies the architecture for common XML schemas and format for data exchange. It makes provision for rules of interactions among various SIF-enabled applications through a Request/Response model that allows events to be published by

an application for others to subscribe to it. XML formatted data is securely encrypted and exchanged through the HTTP channel using the Secured Shell Layer (SSL). However, the SIF Data Model Specifications have different versions and releases for different regions that have adopted the SIF: version 2.0 was released in 2014 for the United Kingdom; version 3.4.3 was released in 2018 for Australia; and version 3.5 was released in 2017 for North America. However, newer version 3 of the SIF Data Model Specification has additional support for JSON and Representational State Transfer (REST) technology for data exchange and events handling over the Transport Layer Security (TLS).

- **Infrastructure Implementation:** Defines the specifications for technology and infrastructure support to implement the SIF in terms of the messaging functionalities and transport protocol that are required for the exchange of data among the SIF-enabled application objects. In the previous versions, the SIF Infrastructure Specification was built on a middleware topology for inter-connecting various SIF-enabled applications with support for XML as the only standard data exchange format for asynchronously transporting messages over HTTP post using the SSL or TLS security support. Meanwhile, the current version 3.2.1 that was released in the year 2017 redefined the SIF Infrastructure Specification on a client/server with broker architecture that uses lightweight RESTful web services to support the transportation of JSON formatted messages over the HTTP using the inherited TLS security.

Relative to the underlying technology and the domain of application, the two key components of SIF can be argued to be the XML specification for modelling the various forms of data that are specific to various education district; and the SOA specification that is concerned with technology implementation standard for sharing data among various EMIS within and between institutions in a district or geographical zones (Leal & Queiros, 2010; Jakimoski, 2016). With the SIF, therefore, the interoperability challenge of integrating various EMIS in different schools within and across education districts is resolved by leveraging on the SOA and the XML technology standards.



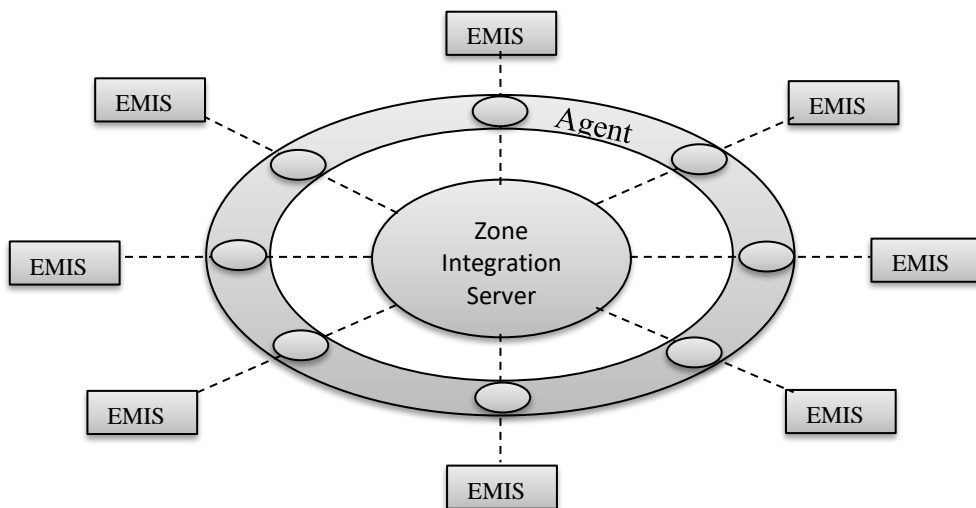

Figure 3.7: Architecture of the SIF (adapted from Jakimoski (2016))

The SIF architecture for achieving integration of various EMIS of different platforms is represented in the Figure 3.7 above, which model a SIF zone that represents an education district. Education data objects are exchanged among the various EMIS through interactions between the SIF Agents or SIF-enabled software applications that are attached to each EMIS and the Zone Integration Server (ZIS) that serves as central coordination and communication point for the SIF Zone. Each EMIS is connected to the ZIS through the publication of its SIF Agent that handles its data request and response activities. Participation in the data exchange activities by any EMIS is through a subscription to the services of other SIF Agents that are registered with the ZIS.

### 3.5.2 Education Management Information Interoperability Framework (EMIF)

The Education Management Information Systems Interoperability Framework (EMIF) is an open technical blueprint, released by the China's National Ministry of Education in 2002 as a component of the China e-Learning Technology Standards (CELTS-40), but as a close imitation of the integration architecture and message format of the SIF specifications (Wang Yanfeng, 2009; Yunyun & Huakun, 2010). The EMIF is considered as a standard for the integration of EMIS of heterogeneous platforms to share and exchange data (Wang Yanfeng, 2009; Dongdai, et al., 2010; Sayed, et al., 2016; Jakimoski, 2016). It is noteworthy that data exchange with the EMIF standard specification is similar to that of the SIF and it is based on the XML as a standard data exchange format over the HTTP transportation protocol and the SOA with WS as technology for design and implementation.

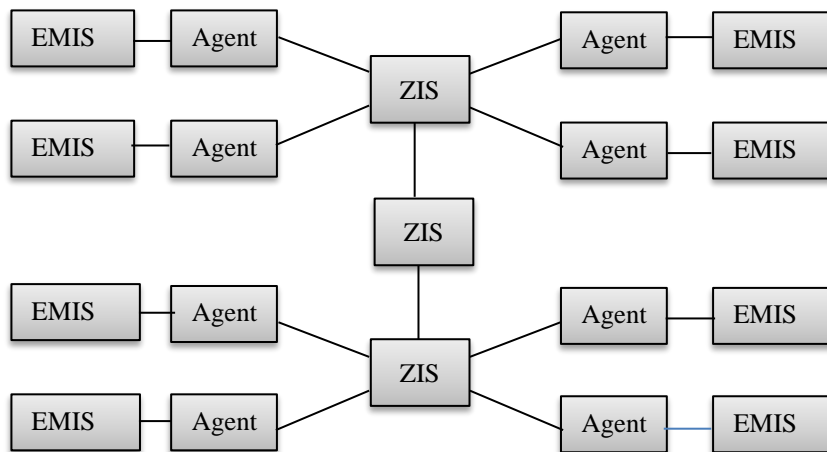

Figure 3.8: Structure and Architecture of EMIF

source: Wang Yanfeng, (2009)

The EMIF specification makes use of the Zone Integration Server (ZIS) as the central communication server, connecting and exchanging data objects among various EMIS through their respective Agents as shown in Figure 3.8. Integration of and communication among various EMIS is by the attached Agents that are registered with the ZIS. The Agents, therefore, acts as application interface that respond to data object request from other EMIS through the ZIS (Wang Yanfeng, 2009) and resolves data exchange by serialising and de-serialising XML messages between EMIS of different platforms (Dongdai, et al., 2010).

Unlike the SIF specification with two key components, the EMIF standard specification is composed of three sections (Yunyun & Huakun, 2010):

- **EMIF Architecture:** Describes the basic concepts, assumptions, models and requirements that are related to EMIF data objects and infrastructure. The structure and architecture of the EMIF, as shown in Figure 3.8, describes an interaction among the various EMIS and their agents that serves as a WS interfaces through the ZIS that act as the pivot for data exchange over the network (Wang Yanfeng, 2009; Dongdai, et al., 2010). This architecture allows EMIS of different platforms and languages to communicate and exchange data within and across schools in same or different education district.
- **Message Format:** Describes the XML-based messaging system that detailed the action to be performed by Agents when exchanging messages through the ZIS. This is captured by a set of messaging standard with defined functions relating to

acknowledgement, registration, subscription, request, event actions and provision of data objects. The transportation of each standard XML message format over the HTTP has two basic elements it carries: the root element that is the main data object being exchanged and the head element that contains descriptive information about the root element (Wang Yanfeng, 2009).

- **Data Model:** Defines the XML structure and exchange model of common data objects and elements that are related to entities in the EMIF structure, which is a considered procedure for sending and receiving data among various EMIS within an education district or region. The EMIF specification defines two data exchange models: Request/Response model that specify the standard for Agents to send and receive messages through the ZIS and the Publish/Subscribe model that specify procedure for Agents to subscribe to services of other Agents through the ZIS and thus receive update data object event when such is triggered by the originating Agent (Wang Yanfeng, 2009).

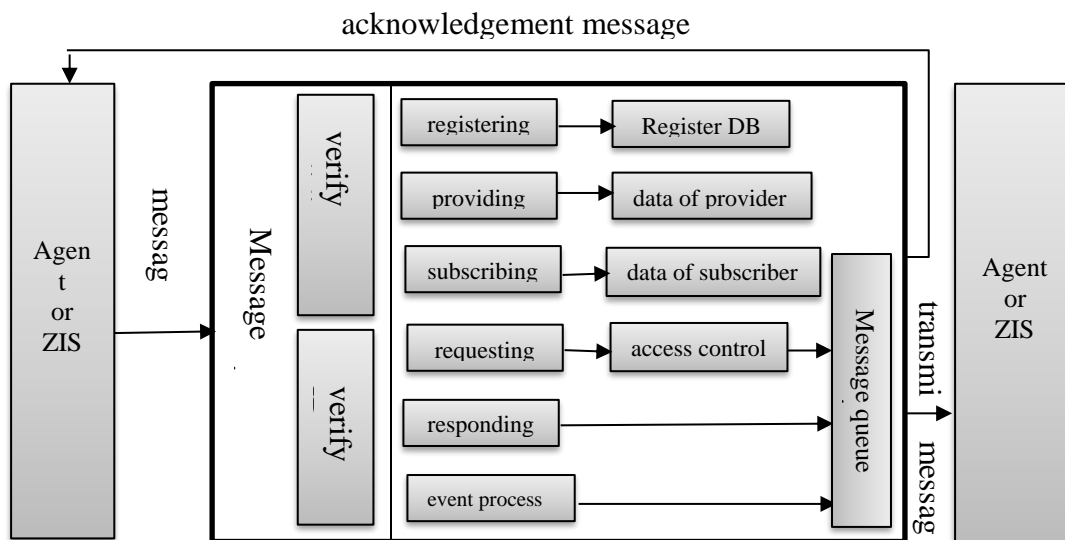

Figure 3.9: ZIS Mechanism for Message Processing and Exchange source: Wang Yanfeng (2009)

The implementation of the EMIF specification for achieving the integration of various EMIS of different platforms and languages is, however, based on the internal mechanism of the ZIS and the Agents interaction for handling messages. In the instance of the ZIS, which acts as information exchange hub in an EMIF, Wang Yanfeng (2009) provided argument on the description of the mechanism for message processing in the ZIS, as shown in Figure 3.9.

The ZIS receives a message and pre-process it to validate the ID and ensure conformity with the EMIF standard message format and to ensure the validity of the sender. The message is then processed by the corresponding processor by a way of registering, providing, subscribing, requesting, responding and event processing. The processed data is then stored in the database or sent into the message queue by the corresponding processor pending transmission to other ZIS or Agents.

Meanwhile, Dongdai et al (2010) classified the message handling activities in the ZIS into four functional modules:

- i. Service module that aggregates the message processors.
- ii. Security Management module that handles the authentication, verification and validation of messages and agents.
- iii. Message Handling module that handles the message queue and forwarding activities.
- iv. Log Management module that logs event activities relative to handling information and operations into the database.

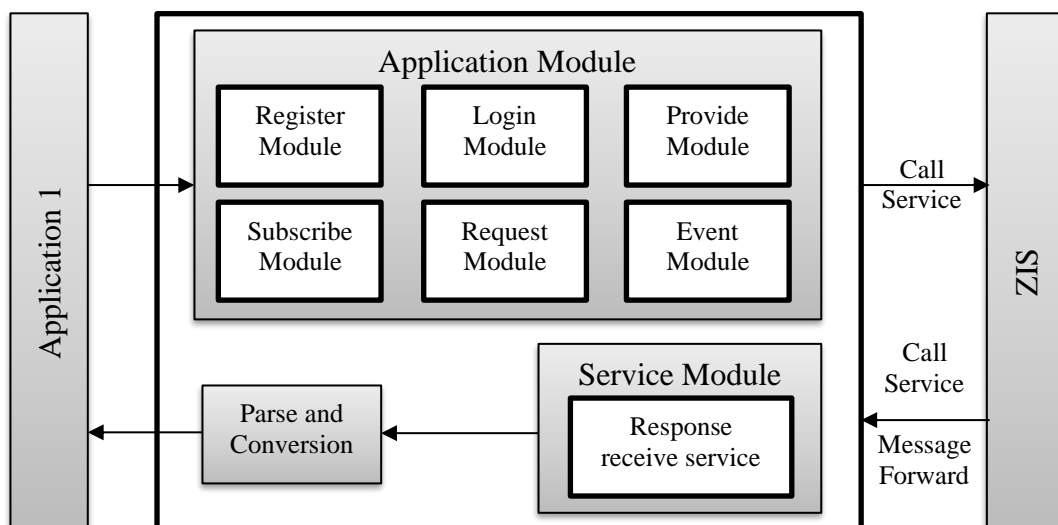

Figure 3.10: Agent Mechanism for Message Processing and Exchange source: Dongdai et al (2010)

In the instance of the Agent, however, Dongdai et al (2010) provided a model of the EMIF specification, as shown in Figure 3.10, for message processing mechanism that specified three functional modules in the EMIF Agent:

- i. Application Module that comprises the register, login, provide, subscribe, request and event services for communicating with the ZIS service for data exchange.

- ii. Service Module that comprises the Response and Receive services for making and responding to requests of the ZIS through the Parse.
- iii. Conversion module that transforms the standard data format to local data format of the receiving Agent.

### **3.6 Benefits and Limitations of EMIF and SIF Frameworks**

The SIF and EMIF implementations and architectures for the integration of various EMIS are scalable to allow for the extension of the ZIS to connect more zones in the education districts. Thus, providing broader views and perspectives to aggregate education data from different local sources.

The exchanged data from different data sources can be cross-referenced for valuable statistics and information to assist top-management in education system to take informed policy decisions.

In context therefore, the key benefits of the SIF and EMIF frameworks can be highlighted thus:

- i. Provision of a standard integration guideline and specifications for data exchange that can be implemented by application developers to expose functional module of an EMIS as services that can share data with other EMIS, within or across education districts.
- ii. Recognition and adoption of standard technologies like the WS with support for XML in EMIF and RESTful Services with support for lightweight JSON in the latest released version of SIF, which simplify and ease the process of data exchange across various EMIS.
- iii. Consideration for flexibility and scalability of the frameworks to allow for extension with possible plug-in of new EMIS to the integration framework.

However, the interaction between the SIF Agents through the ZIS in the course of exchanging data is through a complex connection and communication channels with closely coupled information semantics and low efficiency in transmitting large data volume (Dongdai, et al., 2010; Jakimoski, 2016) that might require higher level of expertise at higher cost of deployment to integrate several EMIS following the SIF and EMIF standards.

In context therefore, the challenges and limitations of the SIF and EMIF for achieving integration of EMIS is also the absence of clear specification for the design structure of EMIS that can further standardise its development and integration for data exchange.

### 3.7 Case Studies of EMIS Integration

In recent past, the integration of EMIS, especially in adding new EMIS to existing systems of different platforms and standards, to expand the scope and functionalities of the entire EMIS infrastructure in education system has received greater attention.

Different researchers have explored the different approaches and technologies to achieve the integration of EMIS; their research studies are themed, based on the approach and underlying technology, and discussed as related work in the following subsections.

#### 3.7.1 SOA with Web Services

Yunyun & Huakun (2003) argued for the use of SOA with WS using the EMIF framework to integrate EMIS of different platforms and programming languages. The integration is designed, as shown in Figure 3.11, as a multi-tier open architecture of three layers: data and model layer, web services layer, and the user layer.

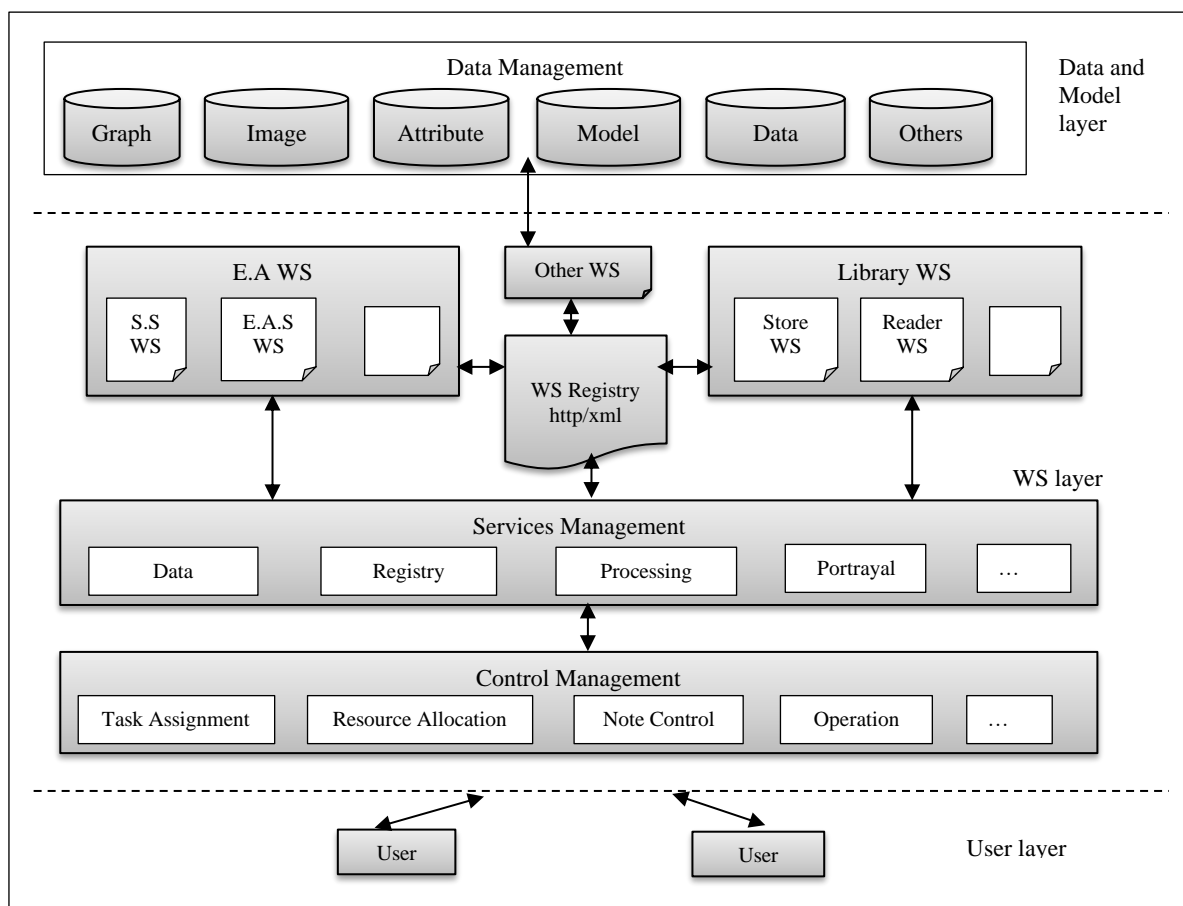

Figure 3.11: Multi-tier EMIS Integration Framework

source: Yunyun & Huakun (2010)

The data and model layer store all forms of public and private EMIS data that can be used by authorised web services. The web service layer represents the core of the interoperability framework handling activities that surround service, control and web service registry managements.

The web services at this layer performs the functions of Agents and ZIS as specified in the EMIF by wrapping each of the EMIF functions as web service that can be shared and re-used for ease of integration. All the web services send and receive data via HTTP and SOAP (with XML) and can call other services. Meanwhile, the user layer provides a platform for end-user and other computing resources with different technical capability and role to access the web services.

### 3.7.2 SOA with Web Services Using Agent Systems

Dongdai, et al. (2010) relied on the EMIF blueprint to argue for a SOA with WS using agents that are embedded in each end of the EMIS and the ZIS server. Integration of EMIS, as shown in Figure 3.12, is made possible by the interaction between the Agents' capabilities of sharing data through the ZIS information exchange centre in two forms: Publish/Subscribe model, with which Agents publish data by sending EMIF Event messages to the ZIS and the Request/Response model with which Agents request data from each other by sending EMIF Request and EMIF Response messages.

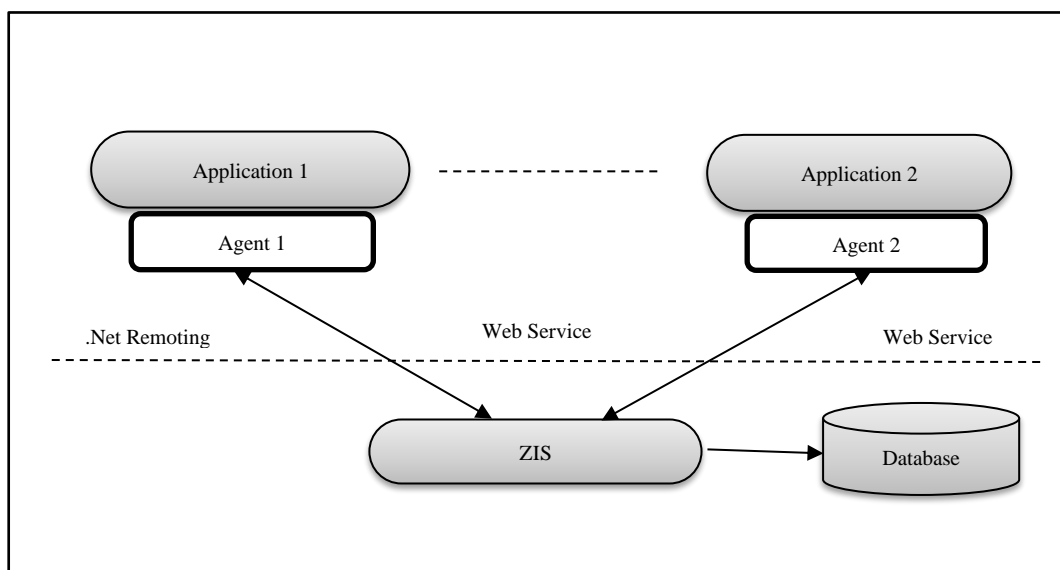

Figure 3.12: SOA with WS for Integration using the ZIS.

Source: Dongdai, et al. (2010)

The interoperability model used the SOA framework to encapsulate the business logic of each EMIS as services that can be shared, reused, and configured to be linked up through standardised service interface.

The model as shown in Figure 3.12 is composed of the Zone Integration Server (ZIS), which act as information exchange centre, and Agents, which bind the data in the EMIS into standardised XML message that can be sent and received through the ZIS. The Agents are integrated in each of the EMIS and communication with each other is by calling the appropriate services of the ZIS. This model achieves interoperability by integrating several applications of different information and communication semantics using web services-oriented agents and middleware in an SOA framework.

### 3.7.3 SOA with Web Services Using Middleware Platform

Chandio, Zhu, & Sodhro (2012) also established an argument for SOA with WS to design a system of interconnecting different information systems in a university. The system i3 was developed with an open-source SOAP engine as a project on the Apache software foundation for web services implementation. Integration is achieved with the system by connecting different system to the system i3, which acts as a middleware.

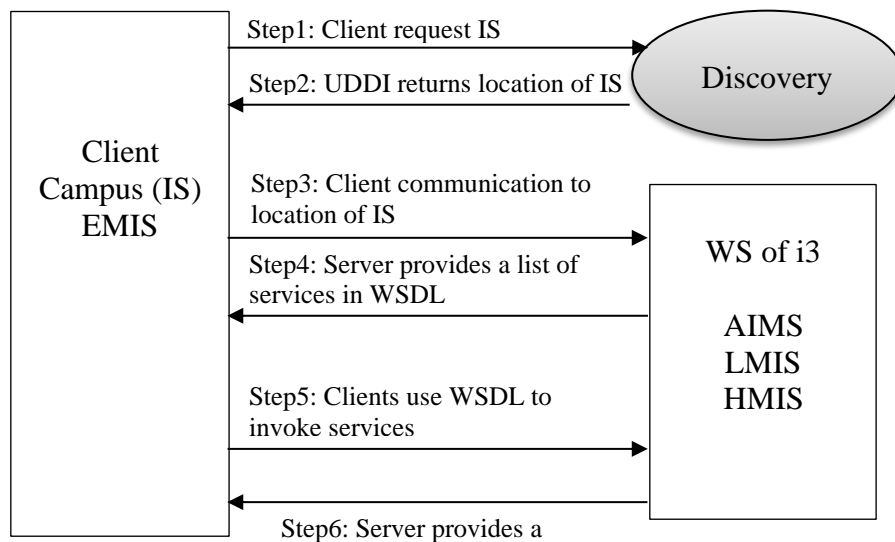

Figure 3.13: SOA with WS for Integration using System i3

Source: Chandio, Zhu, & Sodhro, (2012)

The implementation of the System i3 to demonstrate the interoperability of heterogeneous applications of different platforms in an educational institution is shown in Figure 3.13. It



works with demonstrable five (5) functional modules: Administration Management Information System (AMIS), Library Management Information System (LMIS), Hostel Management Information System (HMIS), Campus Information System (Campus IS) and Examination Management Information System (EMIS). Each of these modules are developed with different programming language and platforms and are tightly coupled together for interaction and integration.

### 3.7.4 EAI with Middleware Infrastructure

In the alternative, EAI is argued by Aserey & Alshawi (2013) with the design of a Higher Education-EAI adaptation model as a mean of integrating multiple information systems in higher education to facilitate information access and re-use. The conceptual model, as shown in Figure 3.14 considered the interaction between the broad classifications of technical and social issues, which are viewed as factors that influence the adoption of EAI in higher education.

At the centre of the HE-EAI adaptation model is the EAI infrastructure, which acts like a middleware where all other information systems connect to. The integration is possible with the EAI infrastructure as each information system connects to it to exchange information with other information systems.

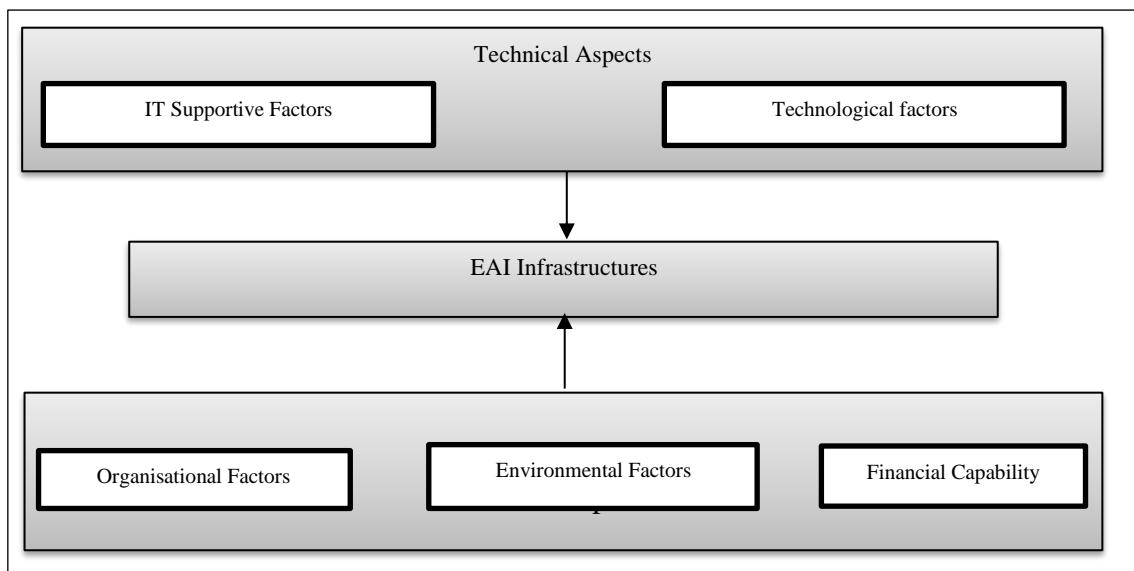

Figure 3.14: Higher Education EAI

Source: Aserey & Alshawi (2013)

### 3.7.5 RESTful API Interoperability Model

Bahaa, Sayed, & Elfangary (2018) proposed an interoperable model of exchanging data across different education platforms using the Representational State Transfer (REST) Application Programming Interface (API) approach. The model is divided into internal and external sections of eight (8) interacting components as shown in Figure 3.15. The components in the internal divide are services that drive the EMIS platform while the components in the external divide are services that are used to communicate with internal services of another platform.

The internal components comprise the Message Queue for asynchronous messaging across external components; Web-Based API/Services communicating message responses between internal and external through service endpoints; Web Service Endpoints that define interface for handling data requests; Cross Platform Interoperability Application System that standardize and facilitate the data transportation and communication between the internal and external services; Directory Services that stores central information about the educational institution; and the Data Base that store the education data.

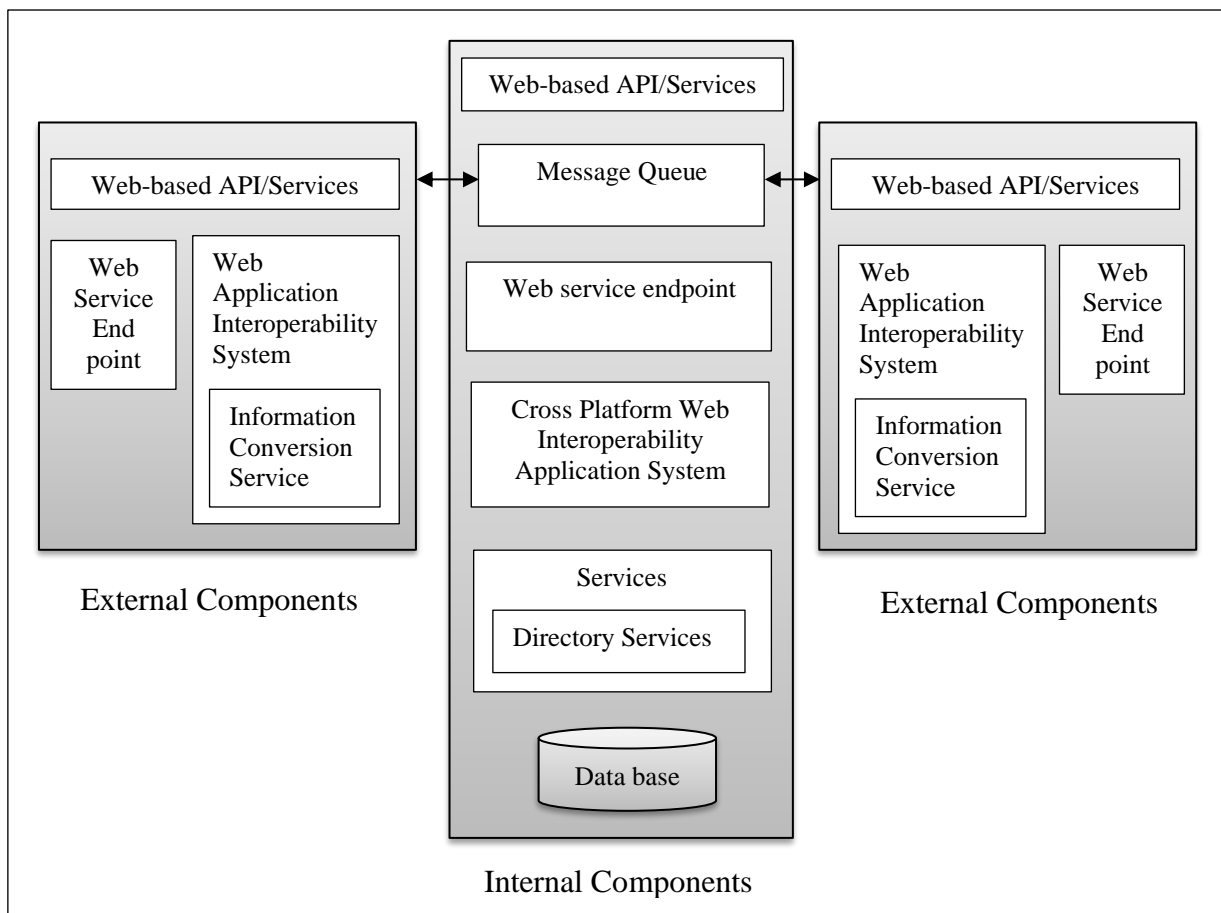

Figure 3.15: RESTful API Interoperability Model.

Source: Bahaa, Sayed, & Elfangary (2018)

Meanwhile, the external divide of the model comprises the Web Application Interoperability System that handles communication of response messages at the internal components layer and the Information Conversion Service that use the JSON standard to serialise and de-serialise data for exchange.

A table of comparison of the related work is presented in Table 3.3 to compare the capabilities and challenges in the arguments of different authors mentioned in the literature.

Table 3.3: Summary and comparison of related work

<b>Parameters</b>	<b>Yunyun <i>et al</i> (2010)</b>	<b>Dongai <i>et al</i> (2010)</b>	<b>Chandio <i>et al</i> (2012)</b>	<b>Aseray <i>et al</i> (2013)</b>	<b>Bahaa <i>et al</i> (2018)</b>
Integration Technology	SOA	SOA	SOA	EAI	-
EMIS Integration	Tight	Tight	Tight	Loose	Loose
Middleware Platform	ZIS	ZIS	System i3	Infrastructure	-
Data Communication	Service	Service	Service	Middleware	Service
Data Serialisation	XML	XML	XML	-	JSON
Communication Channel	HTTP	HTTP	HTTP	-	HTTP
Data Storage	Single	Single	Single	Multiple	Single
Service Discovery	UDDI	Agent	UDDI	-	Directory

While the EAI as exemplified in the work of Aseray & Alshawi (2013) may not be the best approach for addressing the challenges of integration of various EMIS of different platforms due to its lack of details on the data serialisation and communication channel, its support for loose coupling and multiple data storages from different EMIS is a good advantage to consider.

However, the use of SOA in the work of Yunyun & Huakun (2010), Dongdai, Ling, Pan, Zhuo, & Hongyan (2010) and Chandio, Zhu, & Sodhro (2012) offers a better approach on the information and communication semantics of EMIS by providing standard means of addressing the details of data exchange. However, their assumption of a single data storage for EMIS and the inherited complex communication channel for data exchange limits their effective application in integrating EMIS of different data storages.

For the work of Dongai et al (2010) and Yunyun et al (2010) based on the ZIS interoperability framework, the architecture is designed as such that the inclusion of any new EMIS will require the integration of new Agent and the exclusion of any EMIS will equally require a careful removal of the corresponding Agent. Agents' interactions with the EMIS and the ZIS is through complex communication channels and requires manual integration of Agents in EMIS before it can be plugged to the framework.

The complexity in the implementation of the framework coupled with the requirements for man-power efforts in plugging and unplugging EMIS affect its integration, which also impact on its performance and security of information exchange.

Also, from the work of Chandio et al (2012), the tight coupling of the services in each module to the system i3 hinders the effectiveness of the interoperability model. Also, a breakdown of the system i3 would have meant a total breakdown of the integration system. Thus, the challenge of interoperability that was attempted to resolve would resurface.

However, the lack of standard integration technology in the work of Bahaa, Sayed, & Elfangary (2018) is a major limitation to its application in the design structure of EMIS that can scale on integration with other EMIS.

### **3.8 Closing Remark**

The need to create a platform for information exchange across different units in the education system has raised the challenge of integration of several EMIS. The issue of integration becomes more prominent with the observation that different EMIS are developed with different programming languages and platforms. This chapter reviewed literature and raised arguments to answer the second research question:

#### **ii. What approaches, technologies and frameworks are currently used for EMIS integration?**

The integration of several EMIS is to achieve certain objectives, which can be argued to be in consideration of the focus, purpose and level of integration. In the context of this research study, the main purpose of integration at the application level is to focus on data objects to achieve interoperability or data exchange among several EMIS.

The EAI and SOA, aside other techniques, are two possible design techniques for achieving integration. While the EAI approach relates to the use of middleware infrastructure to interconnect various EMIS, the SOA integrates various EMIS by exposing their functional modules as services using such technology of the WS and Web API with support for XML based standard data exchange format or the SWS that uses the RDF and OWL to represent and describe information that can be easily found, shared, and integrated.

To standardise the development of EMIS to achieve integration, the SIF is proposed as an open standard industry initiative in the USA and EMIF is proposed as an open technical blueprint by the Government of China. The two integration frameworks have specifications that defines the architecture and XML formats for data exchange using the SOA with WS technology.

However, the interaction of the services and agents in the SIF and EMIF in achieving integration uses complex communication channels for data exchange. Thus, there is the need to investigate the design of a service-oriented technical framework that will redefine the development of EMIS as an integrated system that uses lightweight and simple communication channels for data exchange. The process of investigation and findings are discussed in the next chapters: Chapter 4 and Chapter 5 of this thesis.

This chapter concludes on a review of some of the case studies of integration of EMIS of different platforms using the EAI and SOA approaches and web service technology. The review considered their significance and challenges in achieving integration of various EMIS.

The next chapter enhances the literature by interrogating the use of EMIS and associated integration challenges through semi-structured interviews with participants from purposively selected universities in Nigeria

## CHAPTER 4 : QUALITATIVE INTERVIEW FINDINGS AND DISCUSSIONS

This chapter presents and discusses the research findings from this study. The findings are based on the responses of participants to semi-structured interview questions that are contained in APPENDIX 1. The participants are selected from five (5) purposively selected Universities in Nigeria. The objective of the interview is to demonstrate a data collection method to investigate the use and challenges with EMIS integration.

The research findings are presented in eleven (11) subthemes, as shown in Figure 4.1.

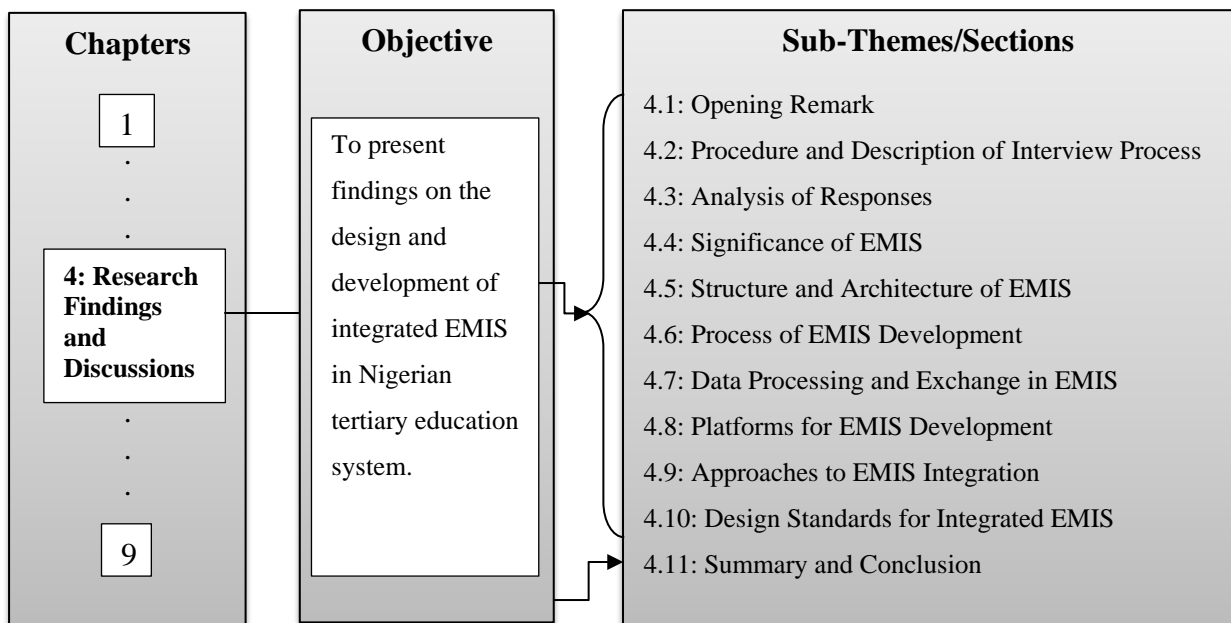

Figure 4.1: Objective Overview of Chapter Four

The Opening Remark subtheme (Section 4.1) provides basis and re-emphasise the approach for the research findings. Procedure and Descriptions of Interview (Section 4.2) details the procedure that was followed in conducting the interviews and the description of the research questions and the respondents that participated in the research study. The subtheme on Analysis of Responses (Section 4.3) describes the findings. The Significance of EMIS subtheme (Section 4.4) discusses the findings on the purpose and benefits of integrated EMIS to the Nigerian tertiary education institutions. The subtheme on Structure and Architecture of EMIS (Section 4.5) discusses the findings on the different forms of design architecture of EMIS and the challenges that are associated with the design approaches. The Process of EMIS Development subtheme (Section 4.6) discusses the findings on the procedure, approaches, modes and implications of the EMIS development process. The Data Processing and Exchange

in EMIS subtheme (Section 4.7) discusses the findings on forms and approaches for processing data and achieving exchange in integrated EMIS. The Platforms for EMIS Development subtheme (Section 4.8) discusses the findings on the technical approaches and platforms for EMIS development. The subtheme on Approaches to EMIS Integration (Section 4.9) discusses the findings on the technical approach and challenges of achieving EMIS integration and the benefits of integrating EMIS for achieving data exchange. The Design Standards for Integrated EMIS Development (Section 4.10) discusses the findings on the practice and challenge for the use of standard design framework for EMIS development. Meanwhile, the Closing Remark subtheme (Section 4.11) aggregates and articulates arguments from the research findings.

#### **4.1 Opening Remark**

Aside the data collection from the review of literature on EMIS and its integration as respectively presented in Chapter 2 and Chapter 3 of this thesis, this research study also collects qualitative research data from expert interviews to present the analysis of the findings from this research study in this chapter.

As indicated in Chapter 1 (Section 1.7.1), this research study is a qualitative research study that adopts the Design Science Research Methodology (DSRM) with clearly defined three (3) distinctive stages: problem identification, solution design and evaluation stages.

To prepare the basis for the solution stage, this chapter presents the primary research findings on the use of EMIS and its integration approaches and techniques in Nigeria's tertiary education institutions. The focus is to gain insights into the challenges and generic requirements for the design of a technical framework for the integrated EMIS development.

The semi-structure interview approach is used to collect data on the research findings. The semis-structure interview approach is considered appropriate for this study because of its ability to afford the participants the latitude to express their opinions to the structured interview question. This, inevitably, impact the quality and reliability of the research findings.

The semi-structured interviews involved the engagement of sixteen (16) participants from five (5) purposively selected tertiary education institutions in Ogun State of Nigeria base on their accessibility and knowledge relevance to the study. Pseudonyms are created for the participants and their institutions, as represented in Table 4.1, to ensure the privacy of their identities as

stated in the ‘Letter of Informed Consent’ that is contained in APPENDIX 2 of this thesis. The procedure and rationale for the interview process is discussed in the succeeding Section 4.2.

The findings from this study are organised and discussed into two (2) parts, as presented in Table 4.2. The first part is aimed at raising questions that bothers on the use of EMIS in Nigerian Universities relative to its significance, forms and challenges. The other part focuses on raising questions that bothers on the design and development of integrated EMIS within the context of its development approaches, data exchange techniques and design framework.

The discussion of the findings from this study is based on the thematic analysis of responses of the participants to question guides in the semi-structured interview, as shown in the attached APPENDIX 1 of this thesis.

## **4.2 Procedure and Description of the Interview Process**

The findings from this research study follows a process of research methodology as articulated in the arguments that are raised in Section 1.7 of this thesis. The approach is to collect and analyse data from the semi-structured interviews with participants in tertiary education institutions that engage in the use and development of EMIS.

The interview questions prepared as guide and the participants were able to provide responses from their individual perspectives as it relates to their use and development of EMIS in their education institution. Responses from the participants are collated to raise arguments for the presentation of the research findings.

### **4.2.1. Interview Procedure**

To begin the process, the participants were contacted by a visit to their respective university with the Letter of Consent (attached as APPENDIX 2) to schedule an appointment for the interview. A copy of the interview questions (attached as APPENDIX 1) were shared with the intended participants in each institution to allow them to prepare for their responses and ensure the quality of the data collection. The number of participants per school is implied in the Table 4.1 below. The data collection process took two dimensions: five (5) participants filled their responses in the interview questions paper and returned as their respective interview response, while the remaining eleven (11) respondents participated in physical interview process of which six (6) participants personally recorded their responses in the interview questions paper



during the physical interview process. The researcher took the recording of responses, on paper and video, for the remaining five (5) participants that were involved in the physical interview.

The dates of the interviews were fixed at the convenience of the participants with the consent and approval of the head of the ICT Department of each institution, who is the administrative and technical head of the department that is concerned with EMIS development. The Head of the ICT department of each institution makes available a special room for the conduct of the interview activities to avoid distractions during the interview process.

Meanwhile, the procedure for the interview considered the following key issues:

- i. **Venue of the Interview:** The interview took place at a designated room space within the ICT department, which is provided by the lead participant at each of the sampled institution.
- ii. **Timing of the Interview:** The interview sessions were conducted in the morning, before the commencement of the daily official activities at each of the sampled institution, to allow the participant to have chance to participate in the interview session without much effect on their daily official task.
- iii. **Length of Interview Session:** The interview across each institution takes an average duration of sixty (60) minutes with all participants in an institution being interviewed at the same time.
- iv. **Interview Approach:** The same question is posed to the group of participants in each of the sampled institutions and they are made to provide separate responses but were allowed to shared views and interject. This is deliberate to strengthen the quality of response and data collection.
- v. **Recording and Transcription:** The interview session in each of the sampled institution was recorded with video camcorder and the responses of each of the participants were transcribed manually in English Language, which was the language that was used during the interview process. The consent of each of the participants was sought in accordance with the ethical considerations (as discussed in section 1.8) and provisions in the Letter of Consent (attached as APPENDIX 2).

#### **4.2.2. Profile of the Respondents**

For purpose of this study, sixteen (16) participants were purposively selected from a cross-section of five (5) purposively selected universities in Nigeria to respond to twelve (12) semi-

structured interview questions, as shown in Table 4.2. The participants are technical staff in the Information and Communication Technology (ICT) department of the selected Nigerian universities. The ICT department in each of the universities is responsible for the design, development and administration of EMIS to drive academic and administrative processes in the universities. These set of participants were chosen on the strength of their accessibility and knowledge relevance to the research study to ensure the quality of response that is required for the analysis of the research findings.

Each of the participants has a depth of technical expertise, using specific programming languages and development tools, to design and develop EMIS as forms of software solutions for use in their respective education institution. They are full-time employee of the respective institution with varying length of years of experience; none is below three (years) of working experience. They work to develop EMIS and provide technical support to end-users in their respective institution.

To conform to the confidentiality provision in the ethical consideration and to properly articulate the arguments from the research findings, the respondents from the purposively selected tertiary education institutions are coded as shown in Table 4.1.

Five (5) Universities were sampled; they are presented in the Institution column, and in no particular order. The University Code and Respondent Code columns are short names to reference each of the sampled universities and respondents respectively. Meanwhile, the Profile Remark column categorises the participants based on their job description and rank in the respective institution as thus:

- **Director:** The head of the EMIS development team and top-level management staff.
- **Assistant:** The assistant or deputy head of the EMIS development team.
- **Programmer:** Application developer and member of the EMIS developer team

Table 4.1: Coding and Identification of Respondents

Institution	University Code	Respondent Code	Profile Remarks
First University	U1	R111	Director
		R112	Assistant
		R121	Programmer
		R122	Programmer
Second University	U2	R211	Director
		R221	Programmer

		R221	Programmer
Third University	U3	R311	Director
		R321	Programmer
		R411	Director
Fourth University	U4	R421	Programmer
		R511	Director
Fifth University	U5	R512	Assistant
		R521	Programmer
		R522	Programmer
		R523	Programmer

It is important to note that all the participants are technical members of the EMIS development team but with administrative hierarchy and rank. The distribution of the participants creates wide basis for robust views of respondents. Thus, the participants are qualified to be described as experts in EMIS development.

#### 4.2.3. Description of the Interview Questions

The semi-structured interview approach is used as a tool and instrument of data collection from experts in EMIS development. Questions were prepared and categorised into two (2): Use of EMIS in Nigerian Universities and Design and Development of Integrated EMIS. The questions were administered on the participants through an approach of semi-structured interviews.

Table 4.2: Description of Interview Questions

Category	Interview Questions
Use of EMIS in Nigerian Universities	<ul style="list-style-type: none"> <li>• What are EMIS?</li> <li>• How are EMIS used in your university?</li> <li>• How will you describe the forms of EMIS that is used your tertiary education system?</li> <li>• Does the development of EMIS as an integrated system assist data exchange?</li> <li>• What are the challenges with the integration of EMIS to achieve data exchange?</li> </ul>

	<ul style="list-style-type: none"> <li>• What are the challenges with the integration of EMIS?</li> </ul>
Design and Development of Integrated EMIS	<ul style="list-style-type: none"> <li>• What technologies and techniques are being used for the development of integrated EMIS?</li> <li>• what factors do you consider for the development of integrated EMIS that can exchange data seamlessly?</li> <li>• What are the approaches and techniques that are currently being used to achieve data exchange in EMIS?</li> <li>• Do you observe any standard design approach for the development of integrated EMIS?</li> <li>• How will you describe the current design approach for integrated EMIS development process?</li> <li>• What are the limitations and challenges of this EMIS design framework</li> </ul>

The categorisation of the interview questions, as shown in Table 4.2 above, is to assist in directing the focus of the research findings.

### 4.3 Analysis of Findings

The responses from the semi-structured interviews were analysed using thematic analysis, which is described as a method of qualitative data analysis (Clarke & Braun, 2013) used to process and identify themes, ideas or pattern of meaning from an array of qualitative data (Maguire & Delahunt, 2017; Caulfield, 2019).

The use of thematic analysis, unlike other qualitative data analysis methods, becomes relevant for this study because it is not tied to any epistemological or theoretical frameworks (Maguire & Delahunt, 2017). Thus, allowing researchers the flexibility of using the inductive or deductive approaches to process data and identify themes based on semantic or latent interpretation (Maguire & Delahunt, 2017; Caulfield, 2019).

This study is interested in the responses and views of participants to each of the research questions. Thus, the inductive approach of the qualitative research methods that allows for

theoretical framework for themes to be formed from analysis of data from research findings (Khazaei & Zalaghi, 2016; Sukma & Saragih, 2017) is adopted using the semantic representation that base interpretation and discussions on the opinions and views of respondents.

Maguire & Delahunt (2017) while citing Braun and Clarke (2006) identify six (6) steps for undertaking thematic analysis, which were adopted and followed for this study:

### **Step 1: Become Familiar with the Data**

This involved the process of transcribing and collating the interview data. An approach of tabulating the responses of the participants against each of the interview questions is adopted to gain a better insight of respondents' views and opinions on each question.

### **Step 2: Generate Initial Code**

The responses of the participants were highlighted in different coloured text to identify the related opinions or ideas that require attention. These highlighted texts were then grouped and given a code to express the main or central idea that were muted in the opinions of the respondents to each interview questions. Open coding is applied because of the inductive approach adopted to allow the data to create the themes to be used for discussion.

### **Step 3: Search for Themes**

Several and related codes across the different questions were re-arranged and re-grouped to form a descriptive theme that implies the generic and relational information about the codes. This process involved the creation of a new table to list all identified codes and related codes were grouped under corresponding theme.

### **Step 4: Review Themes**

This step involved the process of re-mapping the identified themes with the initial codes from the related responses to interview questions to re-establish their relevance and appropriateness in describing the initial ideas and opinions of the respondents. Modification was made to themes to make them more descriptive in nature to capture the generality of the ideas in the related codes. Themes were then modified and divided into subthemes with more descriptive themes to connect them.

### **Step 5: Define Themes**

In this step, the themes were grouped together to connect them with the focus of the research study and form sections for discussion in this thesis.

### **Step 6: Writing-up**

This step involves the presentation of the arguments from the codes to raise discussions for each theme and subthemes.

The thematic analysis of the findings, as shown in APPENDIX 3, further provided basis for clear arguments and discussions around the reviewed themes, which forms the Section 4.4 to Section 4.10 of this chapter.

## **4.4 Significance of EMIS**

The views and arguments of the respondents, relative to the description and significance of EMIS in Nigerian tertiary education system, are discussed in the context of its uses and benefits. These are captured and cross-referenced in the succeeding subsections on Purpose and Usage of EMIS and Functions and Benefits.

### **4.4.1. Purpose and Usage**

Analysis of the responses from all participants in the study shows that EMIS, in the Nigeria tertiary education system, serves diverse purposes and usages. This is corroborated with the argument of Damin, Kadry, & Hamed (2014) as discussed in Chapter 2 Section 2.6.2. Respondents from all the sampled institutions shared the views that EMIS is used to collect, process and manage all the data in the education system. R421 shared the views that EMIS *“helps in data collection system including demographic information of all the stakeholders within an institution, student attendance, course information, result processing and management of financial data within an institution”*. The use-case perspective is further expressed by R522 with the views on the use of EMIS for *“processing and generation of revenue reports from the back-end payment data.”* Meanwhile, R222 summarised the use-case perspective with the view that EMIS is used to *“oversee record keeping within an education institution”*. In essence, therefore, EMIS has evolved as a technology tool that is used by Nigerian Universities to collect, process and store shared data from several EMIS data sources.

The views of respondents also showed that EMIS is used for generating report and providing analysis of the data or information generated from several data sources in order to facilitate

quick and effective decision-making process within the university. For instance, R521 expressed the views that EMIS is used *“to generate report and analyze data to monitor the students’ performance in academic programmes that are offered by the institution.”*. Meanwhile, R523 further articulated the use of EMIS by officials of the Nigerian tertiary institutions to be *“for purpose of performing their user-defined roles in the university”*. However, these views are summarized in the expression of R511 that *“EMIS is used to provide the necessary information needed to support all the activities within an institution”*.

#### **4.4.2. Functions and Benefits**

Participants from the study have convergent views on the functional application of EMIS as a tool to support the activities of the diverse users within the Nigeria tertiary education system. These activities range from generating, sorting, processing, sharing information and decision-making processes. The essence is to use EMIS to carry out their various functions in order to ensure smooth running and easy administrative process.

To substantiate the above argument, participants shared the views that EMIS functions as a tool for making quick and informed decision from the multiple sets of information or data that are captured within the institution. This is evidenced in the response of R411 that EMIS function as a platform for *“providing real-time digital statistics of their institution.”* The information that is provided in the statistical data is, in the views of R311, used to *“make good, informed decision based on the data”*. The capacity of the EMIS to process the data for decision making purpose is evident in the view of R512 that EMIS function as a solution for *“generating, sorting, processing and sharing information within an institution”*.

The views from the respondents also showed that EMIS functions as a tool for communicating and sharing information among all the different academic and administrative units within the institution. Thus, EMIS benefit the education system by serving a platform for managing and coordinating the processes in the education institution. R221 substantiated this with the view that EMIS is used *“to ensure smooth running of the whole process”* This is achievable with the use of EMIS by all forms of users to gain access to data to deliver on their task. This is argued by R511 in the view that EMIS *“supports different users within the education system”*.

## 4.5 Structure and Architecture of EMIS

The analysis of findings from this study reveals that the structure and challenges of EMIS in the Nigerian tertiary education institutions are related to the functions that they are made to perform. This is captured and discussed under the Structure of EMIS in the Nigerian Universities and Challenges with EMIS Design Structure subsections.

### 4.5.1 Structure of EMIS in Nigerian Universities

EMIS in Nigerian tertiary education institution are mainly designed as a web solution with standalone or enterprise architecture to support separate but several functions. In the context of the views and responses of R111, EMIS are structured as separate stand-alone application with each performing specific functions within the university. Meanwhile, R511 shared a divergent view that the university *“uses a locally developed integrated EMIS solution to manage all the academic processes in the institution”*. This is further corroborated with the view from R512 that *“the various EMIS we have in the institution performing specific functions are able to communicate and share information with each other seamlessly through the Integrated EMIS structure adopted”*.

The analysis of findings also showed that the structure of EMIS adopted in the Nigerian tertiary education institution is designed to facilitate internal data and information exchange. This is substantiated in the argument of R121 that EMIS is architected as an education solution with structures that support exchange of *“information across all the various segment or platforms of the institution”*. This structural capacity for data exchange support is further substantiated with a use-case scenario by R211 in the argument that *“we use EMIS to capture, process and share student information seamlessly”*.

In another context, EMIS is structured and architected as a web-based solution with capability for data exchange with external data sources. This is captured in the expressed views of R111 that *“EMIS is fast becoming a standard platform for institutions to meet the National Universities Commission’s requirement by providing the electronic data needed for periodic accreditation of academic programmers in the University”*. The necessity for EMIS to be structured as an education solution with support for internal and external data exchange requires the standardisation of the design framework.



#### **4.5.2 Challenges with EMIS Design Structure**

Respondents from all sampled universities shared the views that there are challenges associated with the design structure of EMIS to deliver on the expected functions. However, these challenges differ from one tertiary education institution to another depending on the capabilities of the EMIS development team in the institutions. This conforms with the argument of Wang & Shi (2012) as seen in Chapter 2 Section 2.6.2

Demonstrating limited knowledge in enterprise solution development, participants from U1 and U2 shared the views that integrating the various EMIS within the institution would make the design structure of EMIS too complicated. In this regard, R121 shared the view that *"the integrated EMIS development increases the complexities of EMIS design structure and over-centralize the back-end database"*. This challenge is further expressed in argument by R222 that developing an integrated EMIS require *"a complex layer of data integration and communication channel that is required to develop and deploy integrated solutions"*. However, respondents from U3 and U5 that used integrated form of EMIS expressed the views that the design and development of EMIS as an integrated system assist and ease the process of seamless data exchange among functional modules. Thus, the extent of this challenge is limited to the extent of technical know-how of the EMIS development team that work with the extensive structure of integrated EMIS.

Meanwhile, for participants from U5 and U2, the changing information requirement of the university system is a great challenge affecting the design structure of EMIS. This is substantiated in the views of R523 that *"the changing information requirement of the institution in most cases leads to the redefinition of the EMIS structure to capture the new development"*. The implication, therefore, is that the request for changes in the information requirement limits the required stability that is needed for use of a standard design framework for EMIS development.

#### **4.6 Process of EMIS Development**

Analysis of the findings from the responses of the participants showed that the EMIS development process begins with setting plans and procedure to deciding on the mode and approach of the development process. However, there are factors and implications for consideration during the development process. These are discussed in the next five (5) subthemes.

#### 4.6.1 Plans and Procedures for Development

The analysis of responses showed that EMIS development process is a two-stage approach that starts with requirement gathering and ends with development activity. However, the respondents shared the views that there is implicit consideration for evaluation at each of the two stages of the development processes to ensure that the EMIS delivers on its key functions.

With respect to the requirement stage, all respondents expressed the views that requirements analysis is critical to the development of EMIS or its integrated functional modules. The analysis of the requirements involves detailed understanding of the data entities and attributes to model the functions and characteristics of the EMIS. From the analysis of responses, participants indicated that the development process of EMIS begins with the requirement analysis, which is contained in a project specification document that act as a guide for the EMIS development team. This argument is captured in the response of R211 that *“we start first by defining the requirement analysis for the EMIS”* and corroborated by R321 that *“in our own case, we first carry out a requirement analysis which is presented as ‘project specifications’”*. This is further addressed in the view from R521 that *“the first thing that we do when we receive a call for new solution to be plugged into the EMIS is to call a meeting of EMIS developers to review the functionalities of the new module”*. These responses emphasize the significance of Requirement Analysis in the EMIS development process. However, R111 underscore the implicit consideration and application of evaluation of the development outcome to reconnect with the requirement stage with the view *“that we keep abreast of what is going on in the field of EMIS and then see to what extent we can bring in useful technologies”*.

Relative to the coding and development stage, R511 expressed the view that *“once we conclude on the analysis of the functionalities of the EMIS modules, the task of development of the solution is assigned to the appropriate programmers to begin the software development process”*. This view on the approach for the EMIS development process is corroborated by respondents from U1 and U2 with the emphasis that there are employed software programming staff to design, develop and deploy EMIS solution once the requirements have been defined.

However, respondents from U3 expressed the view that the development of EMIS is approached from a multi-layer point of view. In this instance, the outcome of requirement analysis is presented as ‘project specifications’ for review and transformation to ‘software codes’ by some external experts and then reviewed and deployed by internal EMIS developers.

This approach of programming code review by external experts strengthens and standardise the coding style within the sampled institution.

The internal standardisation and uniformity of coding enhances EMIS development and ease the process of integrating new solution. However, this standard is local to the institution and do not represent the information requirements and processes of other institutions.

#### **4.6.2 Approaches to Development Process**

The views of respondents are convergent on the approach to the development of EMIS either as a standalone application or integrated solution. In the context of the standalone approach, several EMIS are developed as separate solution to handle separate education task within the tertiary education institutions. R121 shared the view that “*we adopted the stand-alone EMIS approach*” with R211 emphasising the use of several standalone EMIS with the view that “*we have different EMIS that handles separate task*”. In another context, respondents from U3 and U5 shared the views on integrated EMIS as an approach to the development of EMIS that meets the need of the education institution. With the integrated approach, EMIS is developed as an integrated solution with inter-connected module extensions that manage the various education tasks within the education institution.

In either context, the development process of EMIS follows different technology approaches depending on the peculiarities of the education institutions. The extent of peculiarities is within the context of convenience and technical know-how of the EMIS development team within the education institution. In institutions with open-source EMIS as part of the EMIS application suits, the development process of EMIS follows the approach of adaptation of the existing EMIS to model new development.

This is evident in the view of R111 that “*we also make use of the open source and re-modify the source code to suit our own development interface. We can also redesign the whole process*”. This view is further supported by R321 that “*we rely on the existing technologies of the off-the-shelf EMIS that is acquired by the university*”. The adaptation of the existing technologies eases the development process but limit its capacity.

Another technology approach is the development of EMIS on a tiered architecture that separates the design structure of EMIS into separate layers. R522 shared this view on the adoption of “*tiered programming logic for the development process*”. The layered approach

redefines the programming pattern of EMIS development process to focus each layer on specific task: the presentation layer focuses the front-end development that handles the page generation and delivery while the logic and database layers handle the programming logic and database retrieval system approaches.

Meanwhile, the demonstration of this layered EMIS architecture is based on the programming style of using Model-View-Controller approach. This is the view of R512 on the argument that the EMIS development team in the University used *“combination of the object-oriented approach with the Model-View-Controller (MVC) as our choice of coding style in the development process of our integrated EMIS following the tiered programming architecture design”*.

However, the EMIS development team use various technology tools and platforms to deliver on the front-end development process. Such technologies ease the development process and enhance the quality of the programming style. On the choice of the technologies, R222 shared the view that *“I use front-end technologies like HTML, CSS, JavaScript and Angular for developing the front-end interface of our EMIS”*.

Meanwhile, the back-end development that deals with the logic and database is handled by such common programming language like the PHP and the MySQL that are open sources. This is evident in the response of R311 that *“we use open-source technologies like PHP for logic and programming and then use MySQL for the back-end”*.

The view on the use of different technology tools for programming the EMIS front-end and back-end is further strengthened by R522 with view on the use of *“open-source technologies of the PHP as scripting language to handle the logic layer; we use the MySQL to handle the database and then rely on the front-end technologies that is embedded in the Bootstrap to handle the page presentation and loading”*.

In essence, EMIS development process takes the technology approach of using tools and platforms that ease the development process. It also requires the application of a pattern of programming style that enhance the quality of the development process.

### **4.6.3 Considerations for Development**

The Analysis of the findings from participants showed that EMIS are developed based on factors that gives considerations for the specific needs and capacity of each institution.

To underscore the consideration for cost and the specific needs of an education institution in the development process and approach to EMIS, R111 shared the view that *“because of the cost and peculiarities of our institution, we used the custom developed EMIS to run our system”*.

This is further supported by R121 with additional perspective on consideration for capacity to bear the cost in the view that *“I don’t believe in off-the-shelf application, as it mostly does not fit into our own context, as such our EMIS is built by us base on our need and capacity”*. Meanwhile, R522 emphasised the consideration for local requirements in the development of EMIS that meets the need of the institution with the view that *“in order to effectively meet our local requirements as an institution, we use an integrated EMIS that is custom built”*.

The analysis of findings also showed that the competence and technical-know of EMIS development team is an essential consideration in the EMIS development process. This is captured in the view of R211 that the institution opted for the development of standalone EMIS as against the integrated EMIS on the constraint that *“most of our EMIS programmer don’t have the proper technical know-how for such development process”*.

This signifies that the success of the EMIS development project is contingent on the competence of the members of the development team that handle each part of the EMIS development process.

#### **4.6.4 Modes and Approaches to Development**

The EMIS that are used in Nigerian tertiary education institutions takes two modes and approaches: custom-developed or off-the shelf. This is captured in the argument of R523 that the forms of EMIS used in Nigerian universities are either *“stand-alone or integrated which could either be custom made or off-the-shelf”*.

In the instance of the custom-developed approach, the EMIS development process is undertaken by the development team of the education institution. Meanwhile, institutions with limited technical capability employ the services of technical consultants to develop and deploy EMIS as off-the-shelf solution for their use.

In trying to describe these mode and approach to the development and acquisition of EMIS, respondents from U3 identified a form of off-the-shelve integrated EMIS as University Management Information System (UMIS).

The UMIS is a scalable open-source EMIS with integrated functional modules that captures some of the basic tasks in the institution like Self-Service Desk, Courses and Classes Registration, Admissions, Finance Management, Lecturers Management, Student Management, Student Grading Management, Semester Management and Residences Management. However, respondents from the U5 described another form of custom-developed integrated EMIS that is being used in the institution as a web-based integrated EMIS with such integrated functional modules as: Admission, Registration, Payments, Result Processing and Users Profile Management.

The difference in the acquired open-source and custom-developed integrated EMIS that are used by these institutions is in the need and effectiveness to meet local requirements. This is captured in the views of R522 that *“it is usually the best practices to build a locally developed EMIS that suits your institution”*. In essence, education institutions make the choice of approaching the use of EMIS from the perspective of off-the-shelf or custom development based on the need and convenience of the development process.

#### **4.6.5 Implications of Development Approach**

Nigerian tertiary education institutions use different approaches to develop EMIS that meets their requirements. The choice of the development approach has implication on the quality of the EMIS in terms of its functionalities and efficiency in meeting the set objectives.

The analysis of findings shows that the approach to EMIS development that provides for a layer of review of the work done by the development team helps to strengthen and standardize the development process. This is captured in the response of R523 who shared the views that *“in our case, after the requirement analysis have been conducted, transformed to software codes, the codes are then subjected to review by head of the development team in order to strengthen and standardize the coding style”*.

#### **4.7 Data Processing and Exchange in EMIS**

The approach to data processing and exchange in EMIS reflects the forms of EMIS that is used in the education institutions. However, the analysis of findings revealed that the participants use a combination of one or more techniques for data processing and exchange to transport data across the different forms of or modules in EMIS.

The views and arguments of the respondents, relative to the data processing, connection and exchange of EMIS in the Nigerian tertiary education system are captured in the succeeding subsections below

#### **4.7.1 Forms and Structure of Data**

The views of the respondents from U2 and U3 are expressive that EMIS is used for seamless communication and interaction between all the inter-connected modules that are used in the education institution. This process involves the exchange of data across the various forms of EMIS within the institution with different data formats and structures. This is argued by R222 that there is *“difference in data format for each of the various EMIS”*. This view is substantiated with the argument of Panetto & Cecil (2013) as seen in Chapter 3 Section 3.2.1

Meanwhile, the difference in the data format is as a result of the representation and structure of the different data generated in the education institution and processed by the EMIS. The different forms of data for processing are captured in the view of R211 that data being processed by EMIS *“could be structured or semi-structured”*.

The structured data represents the entities and attributes of key education data that is organised in format that can easily be stored in the back-end relational database, while the unstructured data represents such data, like images and videos, that can be much easily stored and referenced from files.

#### **4.7.2 Data Processing and Control**

EMIS is used as a tool to manage large sets of data that is generated within an institution for easy administration of the education system. The growth in the volume of the data is contingent on the configuration of EMIS as a platform that, in the view of R523, *“is made accessible to all the various categories of users within the institution”*, with each user generating a chunk of data.

The increasing volume of data is complicated by the multi-campus structure of the Nigerian tertiary education institutions. Data is generated from the various campuses and is expected to be annexed for processing to generate wide analytics to support decision making process. R122 strengthen this with the view that *“all the various multi-campus sets of information and data in the education”* is handled by EMIS. This conforms with the argument of Hua & Herstein (2003) as seen in Chapter 3 Section 3.2.3

Meanwhile, the huge volume of data that is generated within the education system is processed and analysed with the EMIS to control internal processes within the university. This is captured in the views of R523 that *“we use EMIS to generate data for several purposes such as Admission overview, payment statistics, result and student performance analysis, final year pass list”*.

In another perspective, data processing within EMIS is used to gain insight into user behaviour to guide decision-making process, especially on disciplinary action. This is captured in the views of R121 in the response that *“we use EMIS to reduce to the barest minimum the bad behaviour of students all over our campuses, because we have their full information and details at our fingertips”*.

However, achieving the seamless data processing and control in integrated EMIS is challenged by the difference in the development platforms and the underlying difference in the data structure. This challenge is captured in the view of R121 that *“when management requests data that requires cross platform data processing”* then a number of technical approaches are used to access and exchange data from the various EMIS.

### **4.7.3 Database Connections**

EMIS is connected to a backend database system that stores the data elements that are generated within the education institution. The architecture and connection to the backend database is dependent on the forms of EMIS that is used by the education institution. For institutions that use several standalone EMIS, each EMIS is connected to its separate database.

This is reflected in the opinions of respondent from U1, U2 and U4 but clearly captured in the views of R111 that *“the technique is to keep separate database for each EMIS”*. This is further substantiated by R211 with the response that *“we use several EMIS with each having its own database because integrating our various EMIS would not rally facilitate seamless data exchange”*.

On the contrary, for respondents from U3 and U5 where integrated form of EMIS is used, the several functional modules of EMIS that are used at different units of the institution have a shared connection to the centralized database system.

Retrieval and exchange of data across the several EMIS modules is by using the Structured Query Language (SQL) for various data manipulation activities. This is captured in the views



of R321 and R511, who shared the perspectives that the SQL is used to manipulate data to achieve seamless integration and exchange of data across all the functional modules within the university system.

In the instance where there are several forms of EMIS with separate database sources and connections, there is always a challenge of data integrity as data from these sources, when required for cross-reference purposes, are inconsistent, unreliable, and lacking in integrity. The inconsistency is to the extent that different EMIS at different units of the university system updates their respective data source separately at different time. This is better captured in the view from R121 that *“there would always be challenges with trying to integrate all the various EMIS within an institution especially when management requests data that require cross platform data processing”*.

#### **4.7.4 Data Exchange Approaches**

Regardless of the forms of EMIS that is used by the university, there is convergence of opinion by respondents on the need to integrate several EMIS to exchange data across different units of the university system.

The need for data exchange, in the views of R321, is the basis for integrating EMIS as the respondent argued that *“integrating the various EMIS helps to capture, process and share information easily across all the various segment in the university”*.

Relative to the techniques of achieving data exchange, it is found out that respondents use a combination of one or more of the three techniques described below to achieve data exchange across several EMIS or within functional modules of an integrated EMIS:

A common technique for data exchange across various EMIS involves the use of file export and import. By this technique, data is queried or downloaded from one EMIS and the record is exported, in the requisite format, and then imported into the database of another EMIS, either through a backend database schema or a front-end interface that is developed for such purpose.

A substantial example is given by R111 that shared the view that *“payment information about students of the institution is downloaded in Comma Separated Values (CSV) format from the EMIS on Students’ Fees Payment System and then uploaded, through a file import interface, into the Students’ Result Processing System which requires the students’ fees payment status as condition for processing individual student’s results”*.

This technique for achieving data exchange is common in tertiary education institutions that are using several standalone EMIS systems to drive the tertiary education institution's system. However, a cross-section of respondents in U5 that uses integrated EMIS system also agreed to using the File Import and Export technique to achieve data exchange with sample case provided in the instance of exporting the students' result data from the EMIS on Computer Based Testing (CBT) solution and then importing it into another EMIS on Result Processing System.

Another data exchange technique is the use of shared back-end database. This technique relates to the design and development of the EMIS as an integrated system with shared data source. This technical approach is argued by all the respondents from U3 and U5 as a technical mean of achieving seamless data exchange among functional module of the integrated EMIS. By this technique, data exchange is handled at the logic layer of the integrated EMIS using Structured Query Language (SQL) to seamlessly select and join data elements together.

Meanwhile, the use of Application Programming Interface (API) Connection has evolved as another data exchange technique. The use of API connection is seen as a technical means of achieving data exchange between EMIS of different platforms. With the use of API, an EMIS connects and share data with another EMIS through a defined endpoint channel.

Data is exchanged in a defined format and then re-processed for further use by the receiving EMIS. Instances were provided by respondents on the use of API for data exchange between EMIS. Such instance is provided in the example of R523 where *“API is defined to retrieve the student basic data elements, in real time, from the EMIS that is managing Admissions and consume such data in the proprietary Health Information System called “Smart Doctor” that is used at the Medical Centre of the University”*.

## **4.8 Platform for EMIS Development**

The analysis of responses showed that integrated EMIS is developed on a technology platform that open wider access to users and ease the development process. The development platform and its benefits are discussed in subsequent subsections.

### **4.8.1 Development Platforms**

The analysis of respondents' views showed that EMIS in Nigerian tertiary education system is developed on internet platform as a web-based solution. This is better captured in the

expressive view of R512 that *“the EMIS used in our institution is a web-based”*. This is supported by R311 that *“we have a web portal that handles the student information promptly, both academic and financial records”*.

Meanwhile, to underscore the support of the internet platform for integrated structure of EMIS, R523 shared the view that EMIS is developed as an *“an integrated web solution”*. The choice of developing EMIS to run on the internet platform is hinged on its ease of support for remote access to the platform. It thus provides a basis for consideration of EMIS development to focus on the cloud system to achieve integration.

However, R421 shared the view that the development process, either as standalone or integrated EMIS, is aided with the use of Integrated Development Environment (IDE) like the NetBeans application using object-oriented programming language like the PHP and MySQL as backend database management system.

#### **4.8.2 Benefits and Limitations**

The benefit of using the IDE is shared by R112 and R121 in the view that it helps to ease the development process and makes it easier for a re-use of codes blocks across several EMIS that share the same logic. This view on the benefit of using the IDE is extended by R511 with the response that the platform is *“to make it easy for EMIS to be developed as an integrated system that can easily be scaled with new functional module”*. However, the internet-based approach to EMIS development using the cloud system eases the process of achieving integration of EMIS across institutions.

However, respondents from all the sampled institutions shared the view that the technology and platform difference in the EMIS development constitute a major challenge towards achieving integration across multiple EMIS. This is argued in the response of R322 who shared the view that *“the difference in data format between the various forms of EMIS to be integrated would always pose a challenge due to the underlying technologies of the off-the-shelf EMIS and the custom developed module that is integrated to it”*.

Meanwhile, R321 extended the argument further with the view that *“the inconsistency in the data format and standard between the institutional EMIS and the external government agency requesting for education data is a major challenge to contend with towards achieving integration in the EMIS development process”*.

However, the challenge of technology and platform difference in the EMIS development process is as a result of the absence of development and integration standard to be followed by the EMIS development team of each institution.

## **4.9 Approaches to EMIS Integration**

For EMIS to deliver on its values to the education system, respondents shared the views on the need to integrate several EMIS to exchange data in order to obtain a cross-platform data analytic to support decision-making process. To achieve EMIS integration, several technical approaches are used.

The choice of the approach to achieving the integration is dependent on the technical know-how of the EMIS development team in each education institution. This presents a challenge and limitation to the EMIS integration process. However, the integration of EMIS to achieve seamless data exchange is without some benefits. The issues of approaches, challenges and benefits are discussed in the sub-sections under this section.

### **4.9.1 Achieving EMIS Integration**

In Nigerian tertiary education system, the design approach to the development of EMIS is faced with the challenge of integration to achieve data exchange across the various forms of standalone EMIS or the functional modules in integrated EMIS. These are expressive in the view of R111 that *“there are numerous challenges that come with integrating the various EMIS within an institution”*.

In another perspective, R521 shared the view that the integration challenge in EMIS is *“between the core module and the various functional module extensions”*. In either perspective, achieving EMIS integration requires technical considerations and approaches.

Across different institutions, achieving the integration of EMIS is viewed in the context of the underlying technology and platform for implementing the EMIS development process. For instance, R112 and R121 raised the arguments along the line of the use of Object-Oriented Programming Language (OOPL) as a technical approach of using the coding practice and style to develop EMIS with blocks of re-usable codes that can ease the integration of EMIS to achieve seamless data exchange.

In another perspective, the design practice of developing EMIS as a system with interfaces for interacting services is another approach to achieving EMIS integration. This is captured in the view of R211 that *“one of the techniques that we adopted is the API approach”*.

Meanwhile, respondents across the sampled institutions shared the views that there are key factors for considerations in implementing the technology approach to achieving EMIS integration. These factors include the considerations for the operational mode and framework of the university, format and structure of the shared data elements that are being exchanged, and the connection interface of the main EMIS with the functional extensions. However, the key consideration for these factors is captured in the view of R121 on *“how best to harmonise them”*.

Nonetheless, there is considerable implication for the technology approach to achieving EMIS integration. This implication is focused on the purpose and benefit of the integration process. The key focus is that the EMIS integration approach is to facilitate data exchange. This is captured summarily in the view of R122 that the EMIS integration process is *“to extract necessary information that is required”* to be shared.

#### **4.9.2 EMIS Integration Challenges**

Achieving the integration of EMIS, for the purpose of data exchange, is faced with varied challenges across the tertiary education institutions in Nigeria. These challenges, in the view of R111 *“affects the level of integration that can be done”*. Meanwhile, R221 expressed the view that integration challenge in the context of integrated EMIS limits the capacity of its functional modules to inter-operate with each other.

Meanwhile, achieving EMIS integration in Nigerian tertiary education institutions is constrained by the inconsistency in data format request from the external agency of government. A case scenario of this challenge is shared by R112, who expressed the view that *“external request of information from the National University Commission, which is the regulatory body within the education system, would always pose a challenge of integration”*.

Achieving EMIS integration in the above context requires greater technical competence from the EMIS developers, which is another major challenge. This challenge of low technical skill and competence of EMIS development team is expressive in the view of R511 that in the

absence of *“proper technical skill or up to date programming knowledge, integration in such cases would be very difficult and sometimes impossible”*.

The implication of this challenge is expressive in the form of EMIS design and development approach that is adopted by the development team in each tertiary education institution. This view is strengthened by the response of R112 that *“we adopted the stand-alone EMIS approach in order to avoid the technical complexities involved in the shared database of an integrated EMIS”*. This argument is further supported by R411 that the standalone form of EMIS is adopted *“for us to avoid the complexities that usually comes with sharing and integrating all these data”*.

Another challenge is the changing information requirement of the Nigerian tertiary education institutions that requires the development of new modular extension or changes to the existing module of integrated EMIS. The extent of implication of this challenge is captured in the response of R411 that *“in most cases warrants for re-development in the design structure of EMIS”*. This view is supported by R411.

More so, a case scenario of this challenge was presented by R522 that *“Sometimes, a module is designed and developed based on some specifications and after a while, the specification is changed by the university policy, especially when there is a change of administration”*

However, respondents from all institutions, irrespective of the forms of EMIS that is being used, expressed the views that the differences in the technology platform of the EMIS is a key challenge and limits the ease of integration for data exchange.

This is categorical in the response of R112 that *“the difference in the technology platform for each of the various EMIS”* affects the integration. This view is also put in context by R321 with a case scenario that there is integration challenge due to *“the difference in the underlying technologies of the off-the-shelf EMIS and the custom developed modules”*.

### **4.9.3 Benefits and Limitations**

EMIS in Nigerian tertiary education system is designed and developed as either standalone or integrated systems. In either form, achieving integration of the functional modules of integrated EMIS or the various standalone EMIS is limited by the depth of knowledge and the available time to achieve integration by the EMIS development team.

This is evident in the response of R112 that *“we could not implement due to the structure of EMIS we inherited, and we have the responsibility to manage it till a convenient time to re-develop”*. The response is further supported by the response of R411 that *“we have to keep maintaining the one we have now as developing an integrated EMIS would require a lot of time and effort, which we currently don’t have”*.

Meanwhile, explaining the key benefits of integrated EMIS to the operations of the tertiary education institution, R512 shared the view that the integration of EMIS *“has helped made running the day-to-day activities of the various sectors easier and also facilitate effective decision-making process within the university”*. The ability of EMIS to support effective decision-making process is hinged on the ability of the integration approach to support data exchange across various EMIS.

#### **4.10 Design Standards for Integrated EMIS Development**

The views and arguments of the respondents, relative to the awareness, practice, and challenges of using standard design framework for EMIS development process are captured in the succeeding subsections below. Participants argued that there is a very low awareness about standard design approach for EMIS development in Nigerian tertiary institutions.

They further stressed that this is accompanied with diverse challenges and limitations. However, diverse alternative approaches are adopted in place of a standard design framework for the development of EMIS in Nigeria tertiary institutions. The arguments of the respondents are captured and cross-referenced in the discussions under each sub-theme in this section.

##### **4.10.1 Awareness on Standard Design Framework**

The development of EMIS on a standard design framework is to ensure that every member of the EMIS development team, either within or outside an education institution, can follow a standard procedure for EMIS development. This enhances the efficiency and effectiveness of the integration process to achieve data exchange.

While the use of design standard framework is significant to the development of integrated EMIS to ensure seamless data exchange, the level of awareness on its significance and application is low among the EMIS developers in Nigerian tertiary education institutions. A categorical statement to this regard is shared by R421 that *“we don’t have any design*

*framework for our EMIS development process activities of the various sectors easier and also facilitate effective decision-making process within the university.”*

However, respondents from U5 expressed sense of awareness on the significance and need for standard design framework to guide the EMIS development process. R511 and R522 shared the view that the development team adopted an internal design specification that is prepared by the Director, who is the head of the EMIS development team. A major constraint to this framework is that it is changed as the development progresses and as new requirements for a functional module in the integrated system are being developed. Meanwhile, another means of getting to use a design specification is in alignment with the standard development procedure of outsourced EMIS. This is expressive in the response of R311 that “*we liaise with our external consultants on some guidelines for developing some EMIS module that align with existing solution*”.

In essence, it is safe to align further with the view of R311 that “*there is no generally accepted design standard for the development*”, either for standalone or integrated EMIS solution, in Nigerian tertiary education system. This is an expressed challenge as the design standard evolves with the development process in each institution.

#### **4.10.2 Between Practice and Standard Framework**

The development of EMIS is guided by a design framework to ensure standardisation and consistency in the development approach. The need for the design framework, in the view of R411, is evident “*due to the dynamism involved in EMIS development process*”.

However, R311 shared the view that “*there is no generally accepted design standard for the development*” of integrated EMIS. The absence of a generally acceptable standard design framework for the EMIS development process remains a challenge to achieving EMIS integration, especially for the purpose of achieving data exchange across EMIS platforms.

In the absence of generally acceptable standard design framework for development, EMIS developers in most Nigerian tertiary education institutions explore alternative approaches to ensuring that their application development process is standardised. Such alternative approach includes the use of specifications for EMIS design framework that is prepared and shared by the lead programmer to other members of the EMIS development team.



This is much evident in the response of R411 that *“design standard is majorly based on the thinking or specification of the lead EMIS programmer”*. This statement is further affirmed by R522 that *“there is a form of design standard used in the development process of our integrated EMIS”*. Meanwhile, such specifications, in the views of R121 and R211 are a representation of the depth of understanding of the lead programmer on the requirements for the design and development of EMIS that suit the need of the education institution.

In another perspective, the other alternative practice to the use of standard framework for the development of integrated EMIS is the adaptation and concurrence with the design standard of the open-source solution or external off-the-shelf solution that are used by the education institution. This, in the view of R311, is to ensure that the development process *“key into the existing framework of the off-the-shelf EMIS that is adopted by the university”*.

In essence, the education institution that used standard design specification used what best suit their needs, which in the responses of R511 and R521, shows the inter-connections among the EMIS functional modules and endpoints for data connections. The use of this design specification enhances the understanding of the development team to develop EMIS that can easily integrate with each other. But the standard is local to the education institution and lacks standard development approach that can be adopted by other education institutions.

#### **4.10.3 Challenges and Limitations**

The analysis of the views of the respondents are expressive on the challenges and limitations to the use of standard design framework for EMIS development in Nigeria tertiary education institutions. These are defined within the context of the structure of information requirement of the education institutions and the depth of understanding of the EMIS development team to model the structure for development of integrated EMIS on standard platform.

The information structure of Nigerian tertiary education institutions is represented in the forms of EMIS that are used by the individual institutions. These are, however, subjected to regular changes to reflect new information requirements that, in the views of R511, requires that *“additional functional modules are integrated with increasing potential for data redundancy and inconsistencies in the underlying data structure”*.

The respondent, R511, further shared the view that regular changes to the information requirements, introduces a challenge with *“the complexities in the structure and administration*

*of the integrated EMIS*". The complexities in the EMIS structure due to the changing information requirements of the education institutions limits the standardisation of the EMIS design framework.

This is captured in the response of R522, who shared the view that the framework is evolving and *"requires extensive study to map out a framework that standardize the development process of the integrated EMIS"*.

In education institutions where a local specification is defined as standard framework for EMIS development, the standardisation of such specification is limited by the knowledge of the EMIS development team and the design standard that is used by the outsourced EMIS solution.

This is evident in the response of R521 that the EMIS design standard is *"mostly based on the knowledge of the lead programmer, who coordinates the EMIS development process"* and further emphasised in the response of R311 that *"we liaise with our external consultants on some guidelines for developing some EMIS module that align with existing solution"*. This limitation in knowledge creates challenges in the standardisation of an EMIS design framework that is generally acceptable to the Nigerian education institution.

Relative to the Use of EMIS in Nigerian Tertiary Education Institutions, the findings show that EMIS can be described as an education support system that is majorly developed on web platform and accessible over the intranet or internet. Its significance is majorly to collect and process data, generate data analytics for decision-making and as a requirement for education data exchange during programme accreditation by government regulatory agency.

Findings also shows that some Nigerian universities use some forms of standalone EMIS while others use integrated EMIS that is developed as an enterprise solution with capability for scaling to extend the EMIS functionalities. The design and development of EMIS as an integrated system is, however, considered as a technical approach of achieving data exchange in EMIS.

Meanwhile, analysis of findings show that the process is limited by some identified challenges that are defined by the technology difference in the EMIS development platforms that limits integration; limited technical know-how of the EMIS developers that constrain the development of EMIS as integrated system; difference in the underlying data format of EMIS that affects data exchange; the changing information requirements of the EMIS that

occasionally demand changes to the EMIS structure; and the compelling requests from external sources that are inconsistent with the design structure of the EMIS. These challenges underscore the need for a standard design approach to EMIS development.

Meanwhile, the findings from analysis of respondents' views with regards to Integrated EMIS Design and Development Approaches show that the EMIS development process is collapsed as a two-stage process focusing on requirements analysis and solution development. While the requirement analysis stage articulates the critical elements of analysis and design of functional modules in the EMIS, the solution development involves the programming activities using technology approach that is in the context of the EMIS developers' technical know-how. This limitation affects the development of EMIS as integrated system that can easily exchange data.

Findings show that different technique are used to achieve data exchange such as file export from an EMIS and import into another EMIS; use of shared back-end database to ease data exchange in integrated EMIS and use of API connections to send and receive data through a defined endpoint irrespective of the EMIS design architecture. The API is such a common technique among the sampled institutions but with no standard format for data exchange as it varies across institutions.

The findings from this research study establish the fact that EMIS is significant to the tertiary education system and its development as an integrated system to achieve data exchange is limited by the technical standard for the development process. Thus, a design framework is required for the development of integrated EMIS with standard technical approach for achieving data exchange. The requirements for the design of this proposed framework are presented in the next chapter - Chapter 5.

#### **4.11 Closing Remark**

This chapter provides discussion on the findings from qualitative research study approach that uses semi-structured interview questions to collect data from sixteen (16) purposively selected participants from five (5) purposively selected universities in Nigeria. The findings are analysed using coding approach to thematic analysis. The discussion is presented with inductive approach to present arguments based on respondents' views.

The findings from this research study establish the fact that EMIS is significant to the tertiary education system and its development process requires technical considerations on

architecture, platforms, and integration approaches to achieve data exchange. These considerations require the use of standard technology approaches for the development process. Meanwhile, the analysis of findings also shows that there is no generally acceptable framework for EMIS development that can standardise the development process to achieve seamless data exchange in Nigerian tertiary education system.

Thus, a generally acceptable design framework is required for the development of integrated EMIS with standard technical approach for achieving data exchange. The requirements for the design of this proposed framework are presented in the next chapter - Chapter 5.

## CHAPTER 5 : EMIS DESIGN PRINCIPLES AND REQUIREMENTS

This chapter identifies the underlying design principles and requirements of a standard technical framework for the development of integrated EMIS. The approach, therefore, is to examine and review the research findings in order to provide basis to answer the third research question in this study:

### iii. What are the generic principles and requirements for the design of a service-oriented technical framework that could facilitate the development of integrated EMIS?

The answer to this research question is articulated in the arguments that are provided in the sections under this chapter as provided in the Figure 5.1.

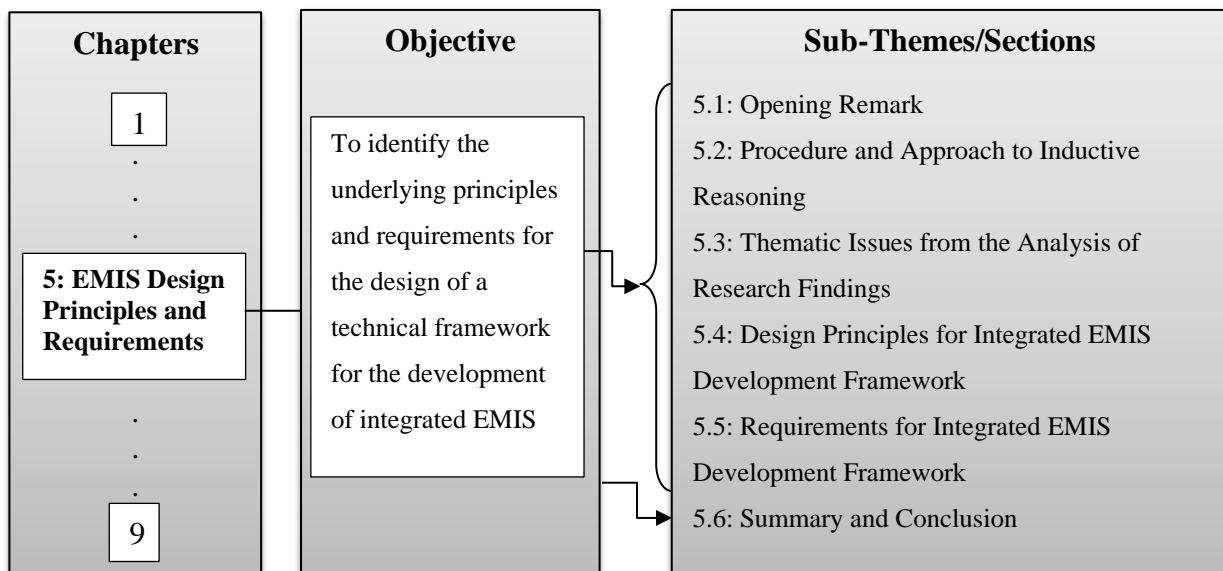

Figure 5.1: Objective Overview of Chapter Five

The Opening Remark subtheme (Section 5.1) set the basis for the review of the research findings and provides basis for this chapter. The Procedure and Approach to Reasoning subtheme (Section 5.2) raises arguments on the procedure for the use of inductive reasoning approach to analyse thematic from the research findings. The Thematic Issues from Research Findings (Section 5.3) subtheme reviews the analysis of findings in this research study to identify the thematic issues that set the basis for the principles and requirements for the design of a technical framework for the development of integrated EMIS. The subthemes on Design Principles for Integrated EMIS Development Framework (Section 5.4) and Requirements for Integrated EMIS Development Framework (Section 5.5) identifies and discusses, respectively,

the principles and requirements that define the design of framework for the development of integrated EMIS that allow data exchange. The Closing Remarks subtheme (Section 5.6) summarises the arguments in this chapter and articulates the answer to the third research question.

## **5.1 Opening Remark**

The analysis and discussion of research findings, as presented in the preceding Chapter 4, provided the basis for this chapter. This chapter, therefore, identifies and examines the key issues that formed the basis of discussions in the analysis of the research findings. These issues are presented as thematic for review.

The application of inductive reasoning, as identified in Section 1.7.2, to extract inference from the review of thematic issues forms the basis for identification of some guidelines for the design and development of integrated EMIS that seamlessly exchange data. These guidelines are identified and generalised as the basic principles to be observed in the design of a service-oriented technical framework for the development of integrated EMIS. Besides, the identified principles are substantiated with evidence from the research findings and the literatures to justify their validity and reliability.

However, a further review and analysis of the identified principles presents some factors for consideration in the design of a service-oriented technical framework for the development of integrated EMIS. These considerable factors are identified as requirements and discussed within the context of factors and conditions to be considered in the design of a technical framework of integrated EMIS development. These requirements form the basis for evaluation of the effectiveness of the proposed technical framework.

## **5.2 Procedure and Approach to Inductive Reasoning**

To make a meaning and draw conclusion out of the review of the thematic issues, inductive reasoning approach that allows researcher to design reasoning approach that suit a study context (Stojanov, 2016) was considered.

This reasoning approach that allows researcher to make observations and form conclusion (Khazaei & Zalaghi, 2016) is applied to the analysis of arguments that are raised in the review of the thematic from the research findings. Meanwhile, Sukma & Saragih (2017) while citing Johnson (1996) argued that “inductive reasoning does not necessarily guarantee that the logical

premises will finally form true conclusion”. However, the conclusions made in this context followed a systematic procedure that enhances its reliability and appropriateness to the research study.

For purpose of this study, the four-step procedure of conducting inductive analysis as argued by Stojanov (2016) is used to analyse the review of the thematic issues from the research findings. The steps and procedure are discussed thus:

**Observation:** This involves the identification of key arguments that are raised in the review of the thematic.

**Analysis:** This step involves gaining understanding of the pattern of argument and identifying the key issues that require considerations.

**Inference:** This step is an extension of the step 2 and involves the generalization of the pattern of arguments to identify issues that need required actions.

**Principle:** This concluding step involves drawing guideline, as design principles, for action to be taken on the inferred arguments.

In the context of this study, the step 1 and step 2 are combined as a stage in the inductive analysis procedure. Meanwhile, the inductive analysis is applied to the review of argument in each thematic from the research findings to identify the principles for the design and development of integrated EMIS.

This is in alignment with the argument of Fu, Yang, & Wood (2016) that inductive reasoning involves processes in which “data are collected first, patterns are extracted, and a theory is developed to explain those patterns”.

### **5.3 Thematic Issues from the Analysis of Research Findings**

Reviewing the research findings and performing a thematic analysis of issues raised by respondents reveal seven (7) thematic areas of concerns as indicated in the APPENDIX 3: Significant Value, Design Structure, Development Process, Data Processing and Exchange, Design Standard, Development Platform, and Integration Approach. These thematic areas are identified and further discussed in the following subsections.

Besides and by inductive reasoning approach to thematic analysis as emphasised in Chapter 4 Section 4.3 of this thesis on the analysis of responses, each of the thematic forms the basis for

some principles and requirements. These principles and requirements guide the design of a service-oriented technical framework for the development of integrated EMIS and are discussed in Section 5.4 and Section 5.5 respectively.

### 5.3.1 Development Process

The analysis of the research findings identifies the Development Process theme as key considerable factor in the design and development of EMIS as discussed in Chapter 4 Section 4.6 of this thesis.

**Observation and Analysis:** The analysis of the discussions in this thematic analysis from the research findings shows that the key arguments are in the context of the approaches, requirements and technical competency that are required for achieving EMIS integration to achieve data exchange.

**Inference:** It can as well be inductively inferred that the key argument relates to the organisation of the information need and technical team that are required for consideration in the development of integrated EMIS.

**Principle:** The Development Process theme presents three (3) guiding principles: Identify the Information Needs of the Education Institution, Set-up and Organise the EMIS Development Team, and Enhance the Technical Know-how of the EMIS Developers as Principle 1, Principle 2 and Principle 3 respectively, which are discussed in Section 5.4.1, Section 5.4.2 and Section 5.4.3 respectively.

### 5.3.2 Design Structure

The analysis of the research findings identifies the theme on Design Structure as another considerable factor that emphasise the structure and challenges in the development of EMIS as discussed in Chapter 4 Section 4.5 of this thesis.

**Observation and Analysis:** The discussion under this theme is on structural considerations for the design and development of integrated EMIS, which identify the specific requirements and challenges for achieving seamless data exchange across the several integrated functional EMIS modules within the education system.

**Inference:** The pattern of argument shows the need, relative to the choice of a design architecture, for the design of framework for integrated EMIS development.



**Principle:** The design structure theme presents one (1) guiding principle on Choose the Design Architecture for EMIS Demonstration that is captured for discussion in Section 5.4.4, as Principle 4.

### 5.3.3 Design Standard

The thematic on Design Standard is identified from the analysis of the research findings as another factor for consideration in the design and development of integrated EMIS. This is discussed in Chapter 4 Section 4.10 of this thesis.

**Observation and Analysis:** It is observed that discussions in this theme bother on design standard for the development of Integrated EMIS in the Nigerian tertiary education institutions

**Inference:** The argument in the discussion shows the need for the use of standard design framework as consideration for the development of integrated EMIS to achieve data exchange.

**Principle:** This theme on Design Standard presents one (1) guiding principles on Adopt a Design Standard and it is captured in Section 5.4.5 as Principle 5.

### 5.3.4 Data Exchange

The thematic on Data Exchange is identified from the analysis of the research findings as a considerable factor that. This is discussed in Chapter 4 Section 4.7 of this thesis and is implied in the consideration for the standard format for data exchange.

**Observation and Analysis:** The argument in this theme focus on the manipulation, retrieval and exchange of data across the several EMIS platforms.

**Inference:** It can be implied that the choice of data format and grant of access to shared database are considerations for the design and development of integrated EMIS that can exchange data

**Principle:** The Exchange theme, therefore, presents two (2) guiding principles: Choose the Standard Data Format for Information Exchange, and Ensure EMIS Gain Access to Shared Database. These guiding principles are captured in Section 5.4.6 and Section 5.4.7 as Principle 6 and Principle 7 respectively.

### 5.3.5 Development Platform

The analysis of the research findings, as discussed in Chapter 4 Section 4.8 of this thesis, identifies the thematic on Development Platform as another considerable factor in the design and development of integrated EMIS.

**Observation and Analysis:** The discussion in this theme identifies the key technique and technology that are used in the development of integrated EMIS to achieve data exchange.

**Inference:** The extract from the analysis of the discussions in this theme shows the emphasis on the need to adopt a standard programming style for integrated EMIS development that can ride on the internet backbone.

**Principle:** This theme, therefore, present one (1) guiding principle as Adopt a Standard Programming Logic for EMIS Development. The principle is captured for discussion in Section 5.4.8 as Principle 8.

### 5.3.6 Integration Approach

The thematic on Integration Approach is identified from the analysis of the research finding, as discussed in Chapter 4 Section 4.9 of this thesis, as a factor that bothers on the approach and constraints for achieving the integration of EMIS.

**Observation and Analysis:** The arguments in this theme are in the context of defining end-point connections approach to extend the functionalities of EMIS with integration of new functional modules to respond to the challenge of changing information requirements of the Nigerian tertiary education institutions.

**Inference:** The import of the argument suggests the need for the provision of endpoint connections and support for new information requirements in the development of integrated EMIS that can easily exchange data.

**Principle:** This theme on Integration Approach presents two (2) principles for consideration in the design and development of integrated EMIS to achieve data exchange: Define Endpoints and Re-usable Methods for Data Exchange and Make Provision for New Information Needs and Plugins. The guiding principles are captured in the Section 5.4.9 and Section 5.4.10 as Principle 9 and Principle 10, respectively.

### 5.3.7 Significant Value

The analysis of the research findings indicates the thematic from the research finding on Significant Value as a salient consideration for the design and development of integrated EMIS as discussed in Chapter 4 Section 4.4 of this thesis.

**Observation and Analysis:** The analysis of argument in this thematic shows the emphasis on the key values of EMIS to the education system.

**Inference:** The value system in this thematic is implied in the need for EMIS to collect and process data from multiple sources and present the data in good format that can assist in the decision-making process.

**Principle:** This theme presents two (2) guiding principles: Collect and Store Data from Multiple Data Sources and Present Data in Format that Support Decision-Making Process. These principles are captured for discussion in Section 5.4.11 and Section 5.4.12 as Principle 11 and Principle 12, respectively.

## 5.4 Design Principles for Integrated EMIS Development Framework

There are twelve (12) identified guiding principles, as shown in the Figure 5.2 below, for considerations in the design and development of integrated EMIS to achieve data exchange.

These generic principles are identified and discussed within the context of Nigerian tertiary education institutions and the arguments that are raised from the views of respondents. This is in the context that principles are generally applicable to a given context and it is often defined by guidelines (Fu, et al., 2016).

Besides, these identified generic principles from the thematic analysis of the research findings are in agreement with the arguments from literature as discussed in the Section 2.5 of this thesis, which identified the data representations, data exchange mechanism, serialisation format and standards, design architecture and development platforms as design considerations in the development of integrated EMIS. The arguments in each of these considerations are captured in the arguments from the thematic, which indicates that the findings align with literature.

Thus, discussions in each of the principles will be further re-validated by arguments from findings and literature to substantiate its relevance, validity and reliability.

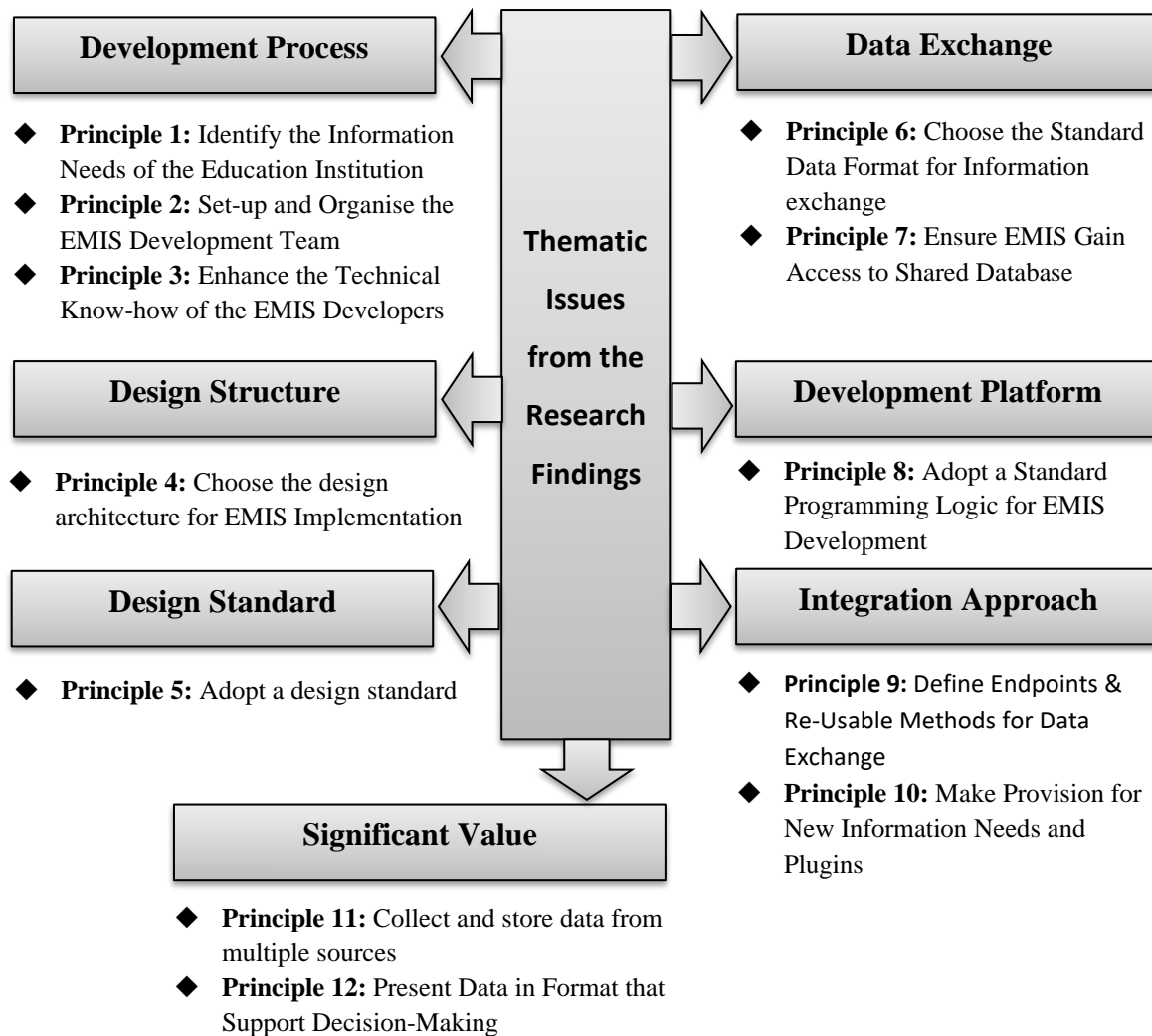

**Figure 5.2: Thematic Issues and Design Principles for Integrated EMIS Development**

### 5.4.1 Principle 1: Identify the Information Needs of the Education Institution

The key element of the critical review process in EMIS development approach is the information needs and structure of the education institution to model a design framework that will support the EMIS development process. Across the tertiary education institutions in Nigeria, the information structure is standard to a greater extent.

It is a representation of the key academic and administrative tasks that require automation in the tertiary education system. These tasks include related activities with admissions, registrations, payments, results, profile, and record managements, among others.

The extent and scope of these tasks that are covered by the EMIS reflects the depth of the information needs of the institution that is exposed to automation. This varies across institutions. Thus, identifying and understanding the information needs and structure of Nigerian tertiary education system and ensuring their privacy is a considerable factor in the development of integrated EMIS.

### **Evidence from Research Findings:**

This principle is captured in the context of Development Process as a thematic issue that is raised in the analysis of this research findings. The principle is based on the identification of the difference in the information needs and requirements of different education institutions and it is evident in the arguments raised by R522 in Section 4.4.2 as:

*“Education system differs by location and educational policies of different institutions. An EMIS in UK may not work effectively and seamlessly with an African Institution based on the peculiarity of our university system. It is usually the best practices to build a locally developed EMIS that suits your Institution”.*

This argument is further corroborated by the views of respondents in Section 4.6.2 to the effect that there are changing information requirements in Nigerian tertiary education system that requires an understanding of the information structure to enhance the design and development of integrated EMIS.

### **Evidence from Literature:**

Carrizo, Sauvageot, & Bella (2003) argued that identifying the information needs of an education system is essential for an effective EMIS development process. This is corroborated with the United Nation Educational, Scientific and Cultural Organisation (UNESCO) report, which posited that it is critical to have a thorough understanding of how the education system works in order to be able to identify the information needs of the system. The information needs are mostly carried out by conducting a need assessment and the flow of information and types of data that are needed within the education system (UNESCO, 2018).

### **5.4.2 Principle 2: Set-up and Organise the EMIS Development Team**

In achieving the development of EMIS as a technology solution that drives the education system, it is important to first establish and assemble a technical team that can deliver on the

task. For Nigerian tertiary education institutions, an organisational unit, University ICT Centre, is established to harbour hired human capacity with requisite technical know-how to drive the development process of integrated EMIS.

However, the technical team, in some other Nigerian universities, is strengthened by the engagement of external technical consultants to leverage the limited number of technical manpower with requisite technical know-how at the University ICT Centres. In either circumstance, the organisation of the technical team for the integrated EMIS development is a required and principled consideration for the development of integrated EMIS.

### **Evidence from Research Findings:**

This principle aligns with the thematic on Development Process on related issues of concerns that are raised from the research findings. The need for Setting-up and Organising the EMIS Development Team is emphasized by respondents' views in Section 4.6.1, especially as emphasised in the response of R511, who stated that:

*“Once we conclude on the analysis of the functionalities of the EMIS functional module, we proceed to the software development process with the appropriate programmers”*

Meanwhile, this principle is also corroborated by the response of R521 as stated that:

*“The first thing that we do when we receive a call for new solution to be plugged into the EMIS is to call a meeting of EMIS developers to review the functionalities of the new module and examine its point of connection with the main EMIS that we have”*

These respondents' views establish the need for setting up and organising a special EMIS development team within the education institution to achieve the expected goal of developing and implementing integrated EMIS to effectively manage the tertiary education system.

### **Evidence from Literature:**

This principle emphasised the need for a team to achieve the development of integrated EMIS. Gondal and Khan (2008) described team in the context of the need for organisation of skilful people with common purpose and roles that are interdependent in nature to achieve development objective.

More so, the key role of the development team to the success of software development objective is argued by Gilal, Jaafar, Omar, Basri, & Aziz (2016) and its importance to software development process is emphasised by Hans van Vliet (2007) with the argument that a team of skillful personnel is required consideration for setting up a technical team for software development process.

### **5.4.3 Principle 3: Enhance the Technical Know-how of the EMIS Developers**

The organisation of the technical team for the development of integrated EMIS is contingent on the level of technical know-how of the team members. In the Nigerian university education system, the technical know-how and competence that is required to design a framework for the development of integrated EMIS is two-folded.

In one-fold, the EMIS development team is expected to have competence in software development technologies and programming languages that can drive the EMIS development process. In another fold, the technical team members require depth of knowledge in the techniques for handling key development processes and the evolving information requirements of the education system.

In practice, therefore, the technical know-how and competency of the EMIS development team is enhanced through a regular in-house workshop to discuss the EMIS solution architecture that can capture the information requirement of the university system, especially when new functional module is required to extend the EMIS functionalities. Thus, a critical review to gain in-depth understanding of the EMIS design and development process is required to enhance the competence of the EMIS development team with consequential effect on the level of their contribution to the development of integrated EMIS.

#### **Evidence from Research Findings:**

This principle is further related to Development Process as a thematic issue that is raised in the research findings. Beyond the observation of the Principle 2, as discussed above, there is the need to further Enhance the Technical Know-how of the EMIS Developer as a principled consideration for integrated EMIS development.

This is evidenced in the respondents' views as raised in Section 4.6.2 and Section 4.6.3 of this thesis. Meanwhile, the emphasis and consideration for this principle is indicated in the view of R322 that:

*“There are occasionally limitations in achieving seamless data exchange with the integrated EMIS due to the differences in the underlying technologies of the off-the-shelf EMIS and the custom developed module that is integrated”*

In describing the limitation, R411 and R511 identified the low technical know-how and competence of the EMIS development team in the use of standard technologies for achieving data exchange in EMIS. Thus, members of the EMIS development team require adequate technical knowledge in implementing a design framework for the development of integrated EMIS that can support data exchange.

#### **Evidence from Literature:**

The principle of enhancing the technical know-how of the EMIS developer is substantiated in the argument by Gondal & Khan (2008) that there is a positive relationship between team empowerment and the performance. Meanwhile, the EMIS development process is described to be knowledge-driven activities that are usually carried out by a team (Colomo-Palacios, et al., 2012; Y.B.Lu, et al., 2011). It relies on the team's knowledge to create an effective integrated EMIS solution (Ryan & O'Connor, 2009).

#### **5.4.4 Principle 4: Chose the Design Architecture for EMIS Implementation**

Consequent upon the structural understanding of the information needs of the Nigerian tertiary education system, there is the need for EMIS developers to decide on the choice of the design architecture that can easily support data exchange across functional modules or across EMIS of different platforms. The context is for the design architecture to model an abstraction of the EMIS solution approach.

The choice of the solution approach specifies the design logic of resolving the complexities in the communication channels across functional elements in the layered framework of the EMIS development process. The design architecture is also to consider the cloud approach that ensure the integrated EMIS can ride on the internet backbone.



This cloud approach with tiered architecture that separates the design structure of EMIS into separate functional layers and defines its communication channel is a key factor for consideration in the development of integrated EMIS that supports data exchange.

### **Evidence from Research Findings:**

This principle is related to Design Structure as a thematic issue raised from the research findings. The structure of EMIS in the Nigerian tertiary institution is designed as a solution to support separate but several functions within the University system, this is evident in Section 4.5.1. Explaining the relevance of the integrated EMIS structure, R512 shared the view that:

*“The various EMIS we have in the institution performing specific functions are able to communicate and share information with each other seamlessly through the integrated EMIS structure adopted”*

The integrated EMIS structure facilitates internal data and information exchange across all the functional modules, this is evident in the example provided by R511:

*“We use EMIS to capture student information, which is then used to process their academic results which is put forward for considerations at the University Academic Board.”*

Thus, it is important to consider the design architect that can ride on the internet backbone as a factor in the development of integrated EMIS that can support data exchange.

### **Evidence from Literature:**

The selection of design structure has been a vital consideration and integral part of software development and prescribes the development process of requirement of the users (Perry & Wolf, 1992). This argument is in the context of the type of data that is captured based on requirements; the mechanism for processing the data; and techniques for sharing and exchanging data.

This is further supported by the argument from (Vliet, 2007) that the design architecture serves as data exchange and communication platform among different endpoints within the education system. In essence, therefore, Alamri, Abdullah, & Albar (2019) raise argument for the adoption of enterprise architecture in higher education on the ground that “it helps them to

better leverage their current resources, capabilities, and competencies to meet institutional needs and manage change effectively”.

#### **5.4.5 Principle 5: Adopt a Design Standard**

Consequents upon the selection of the design architecture, it is essential to adopt a design standard or approach to which the EMIS development process would be hinged on. The EMIS development process in the Nigeria universities is carried out by a designated team in the ICT unit of the institution.

Members of the development team must be guided and agreed on a standard approach to the development of EMIS and its functional modules. This is to create a library of re-usable block of programming codes and methods for sharing and exchanging data objects. Thus, making it an important consideration for the development framework of an integrated EMIS solution.

#### **Evidence from Research Findings:**

This principle conforms with the thematic on Design Standard related issues raised from the research findings and it is implied from the arguments in Section 4.10.1 and evident in the arguments raised in section 4.10.2. Adopting a design standard is essential to the EMIS development process. This is better captured and described by the view from R521 that:

*“We follow our design pattern that shows the flow of data and connection ends of each module,”*

Explaining the benefits of adopting a design standard, R511 shared the view that:

*“The design approach adopted provides the basis for functional modules to share and exchange data with support for scalability to allow for the integration of new functional modules.”*

The design standard for EMIS development is a dynamic and unique process that changes as the need for a new functional module arises. This is captured in the views of respondents from U3 & U5 that the design standard for each institution evolves with the development process.

The respondents’ views’, however, established the absence of a generally acceptable design standard to guide the development of EMIS and its functional modules within the Nigerian

tertiary education system. Thus, the adoption of a design standard is a vital consideration for the development framework of an integrated EMIS.

### **Evidence from Literature**

Adopting a design standard is concerned with intensive problem-solving design process that requires a standard or pattern to be adopted as a key criterion for the successful implementation and evolution of any software development process (Vliet, 2007). The absence of the design standard creates challenges and affects the development of EMIS that can meet requirements and integrate with other education solutions.

This argument is supported by the (Mary-LuzSanchez-Gordon, et al., 2017) that software development is faced with challenge of managing the controls and structures, within the context of human factor – development team, and requires the integration standards techniques that can be adopted as “comprehensive point of reference”.

#### **5.4.6 Principle 6: Choose the Standard Data Format for Information Exchange**

Integrated EMIS development involves the process of implementing the conceptual structure of EMIS as interacting functional modules. Each module implements defined education task using specified programming logic that connects to shared or separate data source.

To gain insight and generate requisite education information, data is collected and processed across functional modules in the integrated EMIS. The exchange of data across EMIS requires a negotiation of the data exchange format by the connecting EMIS platforms to be able to access and store data in native data schema. This consideration for standard data exchange format is critical for the development of integrated EMIS.

### **Evidence from Research Findings:**

This principle is raised from the analysis of issues that are captured in the thematic analysis of the research findings on Data Exchange and it is evidenced in the arguments that are raised in Chapter 4 Section 4.7 of this thesis. Respondent shared the views that data exchange is achievable with the use of Application Programming Interface (API) that defines and requires a standard data exchange format from the two endpoints that connect.

R523 further provided basis to substantiate the need for a standard data exchange format with the description of the use of API to exchange data between two separate EMIS of different

platform and purposes. However, R322 raised arguments on the implications and limitation of integrating EMIS and emphasized the difference in the data structure and format of EMIS. This is captured in the response that:

*“The difference in data format between the various forms of EMIS to be integrated would always pose a challenge due to the underlying technologies of the off-the-shelf EMIS and the custom developed module that is integrated to it”*

This response further underscores the importance of choosing a standard data format for information exchange as a factor in the development of integrated EMIS.

#### **Evidence from Literature:**

This principle is corroborated with the argument from Ahmad & Tsang (2012) that developing a way to standardize and harmonize data using minimal data set is helpful when working toward data interoperability among different systems. Meanwhile, Sayed, Bahaa, & Elfangary (2016) emphasized the importance of adopting a standard data exchange format as a considerable factor for achieving interoperability in the education system and proposed a data exchange platform using RESTFUL web services approach.

#### **5.4.7 Principle 7: Ensure EMIS Gain Access to Shared Database**

In a layered EMIS architecture, the database is separated as an application layer to perform data storage function while granting access to authorised users to retrieve or manipulate stored data. In essence, the programming logic layer of each functional modules of the integrated EMIS requires access to the shared database to trigger data retrieval, manipulation, and storage as appropriate.

This is invoked by the re-usable methods and objects that are defined by the EMIS programming logic through the database query engine. However, access to the shared database requires a connection string that defines the access credentials to the database storage engine. Thus, in designing a framework for integrated EMIS development, it is necessary to ensure that EMIS programming logic gain access to shared database to be able to process the various data elements for information management.

### **Evidence from Research Findings:**

This principle is based on the Data Exchange thematic as identified in the analysis of findings in this research study. The evidence for this principle is seen in the arguments raised by respondents in Section 4.7.2 on the need for EMIS to process and present data analytics to support decision-making process in the education system.

Meanwhile, respondents from U3 and U5 in Section 4.7.4 argued that the Structured Query Language (SQL) is used to select and join data elements from different data sources together. This enhances the base for the collection of data elements to support the analytics. It, therefore, implies that the EMIS is required to gain access to shared database to retrieve and manipulate data to support analytics.

### **Evidence from Literature:**

Sayed, Bahaa, & Elfangary (2016) posited the need for a central information exchange system within the education system to resolve interoperability challenge in the design and development of integrated EMIS. This is considered necessary as an intermediary platform for each EMIS to gain access to the heterogeneous data from the different EMIS that is used within the education system (Aserey & Alshawi, 2013). There are, however, different means of achieving and ensuring access to the different data sources using the layered services as argued by Mikreyyohannes and Omer (2013) and the Multi-Agents services approach by Al-Yaseen, Othmana and Nazri (2016) for accessing and exchanging data from heterogeneous data sources.

#### **5.4.8 Principle 8: Adopt a Standard Programming Logic for EMIS Development**

One of the critical activities in the EMIS development process is the representation of the EMIS design logic in a programming construct using a defined programming language. For most tertiary education institutions in Nigeria, the development of EMIS is a collaborative effort from members of the EMIS development team.

Defining an acceptable programming style that standardises the construction of functional methods, objects, and data in the EMIS programming logic eases the process of re-use and invocation of such methods by components of the EMIS functional modules. The adoption of standard development environment that rely on the internet backbone and development framework with extensible libraries of methods and functions that can easily be invoked and re-used is a common programming style by EMIS development team in Nigerian universities.

### **Evidence from Research Findings:**

This principle relates to the thematic issue of Development Platform as identified in the analysis of findings in this study and it is evident in the views of respondents in Section 4.8 of this thesis. The need to use standard programming logic for the development of integrated EMIS is indicated in the response of R521 thus:

*“We write our codes with object- oriented approach using the Model-View-Controller methods to make it easy for EMIS to be developed as an integrated system that can easily be scaled with new functional modules”.*

This view is corroborated by other respondents from other institutions as they all raised argument on the use of a programming style to present the solution pattern for the development of integrated EMIS. The consideration for the internet backbone is provided for in the view of R523 that EMIS is developed as an *“an integrated web solution”*.

### **Evidence from Literature:**

This principle is corroborated by the argument from Foxwell & Peacock (2015) that standard programming practice ensures that all programmers working on a development process follow a standard that is easy to read and maintain over time and develop codes that can be reused by other components. Thus, standardization of programming language helps to prevent any form of error and potentially lead to a more efficient and effective EMIS development process.

#### **5.4.9 Principle 9: Define Endpoints and Re-Usable Methods for Data Exchange**

Data exchange across EMIS requires a definition of standard communication and transportation channels that can be exposed for secured access. This principled consideration for the design of framework for integrated EMIS development requires that EMIS defines and expose some endpoint connection addresses through which data can be securely accessed by some other EMIS in a specified semantic data format over a transportation channel.

This approach for data access and transportation across platforms makes it easy for data objects and methods to be re-usable across EMIS of different platforms. Tertiary education institutions with varied EMIS platforms use the standard and secured endpoint connections to integrate EMIS and exchange data. Thus, reducing cases of data redundancy and improving data integrity and reliability as education data is shared across EMIS platforms.

### **Evidence from Research Findings:**

This principle is based on the thematic on Integration Approach and it further extends the considerations for Principle 6. It is captured from the implied arguments in Section 4.9. Respondents shared the views that API is a preferred technology approach to achieve data exchange across EMIS, irrespective of the differences in the underlying data structure and format.

To achieve this, EMIS is required to define and expose endpoints to send and receive exchanged data objects or methods. Meanwhile, the exchange of re-usable methods is raised by respondents from U3, U4 and U5 in Section 4.9.1 as an approach of executing the programming logic of EMIS. Thus, it is necessary to consider the definition of endpoints and re-usable methods as factor for the development of integrated EMIS that easily exchange data.

### **Evidence from Literature:**

This principle is corroborated with the argument from (MINEDUC, 2017) that an API Gateway will provide, manage, and secure access to the integrated EMIS by allowing potential application developers to search, browse, and locate APIs that meets desired functionality while improving data reuse. Thus, defining end point and reusable method of data exchange is a critical consideration in the development of an integrated EMIS framework.

#### **5.4.10 Principle 10: Make Provision for New Information Needs and Plugins**

The development of EMIS is a continuous practice that is hinged on regular update and extension of functionalities to capture emerging information needs of the tertiary education system. To properly capture new information needs on emerging education tasks within the tertiary education system, new programming codes or methods are defined as a plugin to extend the functional modules in EMIS.

In the context of this, it is appropriate to consider the design of EMIS framework as a scalable structure that can respond to new information needs and allow easy plugin of new functional modules or methods.

### **Evidence from Research Findings:**

This principle relates to the identified thematic issue of Integration Approach as raised in the analysis of research findings in this study and it is evident in the views of respondents in Section

4.8. Respondents from all the institutions shared the views that there is a challenge of changing information requirements that occasionally affects the structure of the integrated EMIS design and development process. Meanwhile, the implication of the changing information requirements is emphasized by R521 in Section 4.5.1 with the response that:

*“The first thing that we do when we receive a call for new solution to be plugged into the EMIS is to call a meeting of EMIS developers to review the functionalities of the new module and examine its point of connection with the main EMIS that we have. We also check its implication to determine if any change is required in the main EMIS to accommodate the new functional module”.*

Thus, there is the need to consider and make provision for the new information needs and requirements in the development of integrated EMIS. This will ensure that such new requirements are packaged as a new module that can be plugged into the integrated EMIS framework.

#### **Evidence from Literature:**

This principle is substantiated with the (UNESCO, 2018) report that information needs of the tertiary education system are not static but evolves with time. The information needs must be regularly re-assessed to check the consistency of EMIS to meet the set education objective. Meanwhile, the (UNESCO, 2018) report further argued that EMIS must be developed to respond to the changing information needs of the tertiary education system by making provision for it in the development process.

#### **5.4.11 Principle 11: Collect and Store Data from Multiple Data Sources**

Processing of data elements by EMIS to deliver useful information to support management decision making process is contingent on a framework of support for collection and storage of data from multiple sources. These multiple data sources can be different data objects or segments of shared database or different data elements from different local or remote databases.

Thus, beyond being able to gain access to shared database, EMIS is required to collect data from the front-end, use the internal logic layer to process and manipulate the data, and then send the data to the database engine for storage. These technical activities of data collection



and storage is a required design consideration for the development of integrated EMIS that can process data for exchange.

#### **Evidence from Research Findings:**

This principle is captured in the thematic analysis of the research findings on Significant Value and it is a step further on the argument that is provided to substantiate Principle 7. The principle is evident in the implied argument in Section 4.4 and complements the argument that different units of the university system generate and interact with different data from different sources.

This then implies that EMIS is to be designed to collect data from different data sources and then unify these data by processing what is fetched before storage. To justify the need for accessing data from multiple sources, R112 and R311 presented different scenario where information that is needed to support decision-making within the education system is collected from multiple sources.

#### **Evidence from Literature:**

This principle is corroborated with the (UNESCO, 2018) EMIS report that EMIS is used to provide valuable data for information processing within the education system. These processes are interconnected and take place at various academic and administrative levels within the education institution.

The report further added that for EMIS to be effective, it should not only collect, and store data but also be able to respond in a timely but flexible manner to various demands for data from the diverse or multiple sectors within the education system. Thus, the technicalities of data collection and storage is an important consideration for the development of an integrated EMIS that can process data for exchange.

#### **5.4.12 Principle 12: Present Data in Format that Support Decision-Making**

Presentation of data in a format that enhances understanding and support decision-making is a considerable factor in the design of framework for integrated EMIS development. EMIS data are stored in structured relational format in the database storage engine but require transformation and styling to present it in user-friendly format that enhances readability and insight.

For Nigerian tertiary education system, the presentation of data from cross-referenced sources to provide statistics and analytics is one of the critical purposes of using EMIS to support the education system.

### **Evidence from Research Findings:**

This principle is presented under the Significant Value as a thematic from the analysis of the research findings and it is evident in the issues that are captured from the views of respondent in section 4.4. R521, while describing the purpose of EMIS, emphasized the statement that:

*“EMIS is used in the university to generate reports from data that is being gathered and analysed to monitor the performance of academic programmes that are offered by the University”*

From this description of EMIS, it is evident that EMIS is required to present report, which contains data from multiple sources to generate analytics, in a format that can support decision-making process. This is a factor for consideration in the development of integrated EMIS.

### **Evidence from Literature:**

EMIS generates data from multiple sources characterized by the volume and complexity of the different data format (Chen & Hsieh, 2014; Clark & and Golder, 2014; Desouza, 2014; Ho & McCall, 2016). To create meaning and support for decision-making, the data needs to be transformed into understandable information with analytical insights (UNESCO, 2013).

There is, therefore, the need for end-users to operate the system and make good use of the data for informed decision-making process. Thus, the presentation of data in simple format that support decision-making process is a very important consideration for the development of integrated EMIS that support seamless data exchange across platforms.

## **5.5 Requirements for Integrated EMIS Development Framework**

In the context of the Nigerian tertiary education system, this study identifies twelve (12) guiding principles for the design and development of integrated EMIS, as discussed in the Section 5.4 of this thesis.

These principles are further reviewed and grouped based on relevance and relationships to identify the generic requirements to be met in designing a service-oriented technical framework for the development of integrated EMIS that ease and ensure seamless data exchange.

The identification of the requirements from the principles follows the procedure on inductive reasoning approach as discussed in Chapter 5 Section 5.2 of this thesis. Meanwhile, the observation and analysis stages are done by grouping related principles base on the relevance and relationship. Inferences are drawn based on the pattern of arguments to identify common and central argument in the related principles.

The requirements, as shown in Table 5.1, are drawn from the inferences as themes that identify the key conditions to be met by a service-oriented framework for the development of integrated EMIS. Each of these requirements are further discussed in the succeeding sub-sections.

Meanwhile, the significance of these requirements is strengthened by the discussion in section 2.5, which identifies some of the basic considerations for the development of integrated EMIS.

Table 5.1: Requirements for Designing Service-Oriented Framework for Integrated EMIS Development

<b>Observations &amp; Analysis</b>	<b>Inferences</b>	<b>Requirements</b>
Principle 1: Identify the Information Needs of the Education Institution	Articulating and adapting to the specific information needs	Adaptability
Principle 2: Set-up and Organise the EMIS Development Team Principle 3: Enhance the Technical Know-how of the EMIS Developers	Structural arrangement for supporting and maintaining the development	Maintainability
Principle 4: Chose the Design Architecture for EMIS Implementation Principle 5: Adopt a Design Standard Principle 6: Choose the Standard Data Format for Information Exchange	Use of standard technologies and techniques	Standardisation

Principle 8: Adopt a Standard Programming Logic for EMIS Development		
Principle 9: Define Endpoints and Re-Usable Methods for Data Exchange Principle 10: Make Provision for New Information Needs and Plugins	Structured to enhance extension	Scalability
Principle 7: Ensure EMIS Gain Access to Shared Database Principle 11: Collect and Store Data from Multiple Data Sources	Connecting multiple data sources	Connectivity
Principle 12: Present Data in Format that Support Decision-Making	Access and presentation of data	Accessibility

### 5.5.1 Adaptability

The analysis of the arguments in the Principle 1: **Identify the Information Needs of the Education Institution**, as discussed in Section 5.4.1 of this thesis, emphasised the importance of considering the specific information needs of the education institution in the design and development of integrated EMIS.

This underscores the difference in the information structure and the peculiarity of the information needs of each education institution. Thus, the design of a framework for integrated EMIS development needs to meet the adaptability requirement that consider the specific information needs of the education institution.

### 5.5.2 Maintainability

The need for ensuring structural arrangement for the design and development of integrated EMIS can be inductively inferred from the analysis of arguments in Principle 2: **Set-up and Organise the EMIS Development Team** and Principle 3: **Enhance the Technical Knowledge of the EMIS Developers** as discussed in Section 5.4.2 and Section 5.4.3 respectively.

Meanwhile, the emphasis for the need to consider the organisation of EMIS development team and ensuring their knowledge capacity underscore the need to ensure a structure that support the development and maintenance of the EMIS development process.

Thus, the maintainability requirement that considers a structure of EMIS that is designed to be serviced within the competence of the development team needs to be met in the design of framework for integrated EMIS development.

### **5.5.3 Standardisation**

The analysis of the arguments in the Principle 4: Choose the Design Architecture; Principle 5: **Adopt a Design Standard, Principle**; Principle 6: **Choose the Standard Data Format**; and Principle 8: **Adopt a Standard Programming Logic for EMIS Development** emphasise the use of standard technologies and techniques for the design and development of integrated EMIS.

The use of the standard internet and cloud-based technologies and techniques ease the data exchange across different platforms. Thus, standardisation of technologies and techniques is a requirement to be considered in the design of framework of integrated EMIS development.

### **5.5.4 Scalability**

A careful observation shows the connection between Principle 9: **Define Endpoints and Re-Usable Methods for Data Exchange** and Principle 10: **Make Provision for New Information Needs and Plugins** and the analysis of pattern of arguments in the two principles emphasise the need for structural arrangement for extending and enhancing the functionalities of integrated EMIS development.

This underscores the need for seamless connections to extend the functionalities of EMIS with integration of new functional modules to respond to the changing information requirements of the Nigerian tertiary education institutions. Thus, the consideration of the scalability requirement for the design of framework for integrated EMIS development that provides for endpoint connections for extending EMIS functionalities.

### **5.5.5 Connectivity**

The analysis of arguments in the related guiding principles of Principle 7: **Ensure EMIS Gain Access to Shared Database** and Principle 11: **Collect and Store Data from Multiple Data**

**Sources** emphasised the need for the design and development of EMIS to ensure connections to multiple data sources.

This underscores the need for the design and development of EMIS to gain access and exchange data element across multiple back-end databases. Thus, a design framework for integrated EMIS development need to meet the connectivity requirement to make provision for connection to several data sources for seamless data exchange.

### **5.5.6 Accessibility**

The analysis of pattern of arguments in the Principle 12: **Present Data in Format that Support Decision-Making** emphasise the need for the design and development of EMIS to be usable to meet the needs and expectations of the various end-users.

This makes it important for the design of a framework for the development of integrated EMIS to meet the accessibility requirement that access and transform data in format that support varied expectations of end-users.

## **5.6 Closing Remark**

This chapter examines and reviews the analysis of research findings as discussed in the preceding Chapter 4 to identify seven (7) thematic issues: Development Process, Design Structure, Design Standard, Data Exchange, Development Platform, Integration Approach and Significant Value.

These thematic presents the areas of concern from the analysis of research findings and are further reviewed by inductive reasoning to identify twelve (12) guiding principles, as discussed in Section 5.4, that are actionable guidelines for considerations in the design and development of integrated EMIS. The justifications for the principles are made from the views of respondents to semi-structured interview and the arguments from literatures.

This chapter, therefore, raises arguments to answer the third research question in this research study:

- iii. What are the generic principles and requirements for the design of a service-oriented technical framework that could facilitate the development of integrated EMIS?**

To answer this research question, the twelve (12) guiding principles were further grouped and reviewed based on relevance and relationship using inductive analysis procedure to identify six (6) generic requirements that represent the conditions to be met in designing a framework for the development of integrated EMIS.

These requirements are identified as Adaptability to meet the specific information needs of an education system; Maintainability to ensure ease of servicing the EMIS structure; Standardization of the technology and techniques for the design and development of integrated EMIS; Scalability with endpoints for extending EMIS functionalities; Connectivity that provide connections to multiple data sources for data exchange; and Accessibility of the framework to enhance the EMIS' user experience with transformation of data in format that meet varied expectations.

The requirements for the design of a technical framework for integrated EMIS development, as identified and discussed in this chapter, is used to design a proposed service-oriented technical framework for the development of integrated EMIS. The proposed technical framework is presented for discussion in the next Chapter 6.

## CHAPTER 6 : PROPOSED TECHNICAL FRAMEWORK

This chapter raises arguments on the proposition of a service-oriented technical framework for the development of integrated EMIS. The chapter, therefore, reviews the contextual issues around the challenges, solutions, and requirements for the design of a technical framework for the development of integrated EMIS that simplifies the process of data exchange within the education system. The argument in this chapter provide basis to answer the fourth research questions in this study:

### iv. How can a service-oriented technical framework for the development of integrated EMIS be developed and designed?

The answers to this research question are articulated in the arguments that are provided in the sections under this chapter as provided in the Figure 6.1.

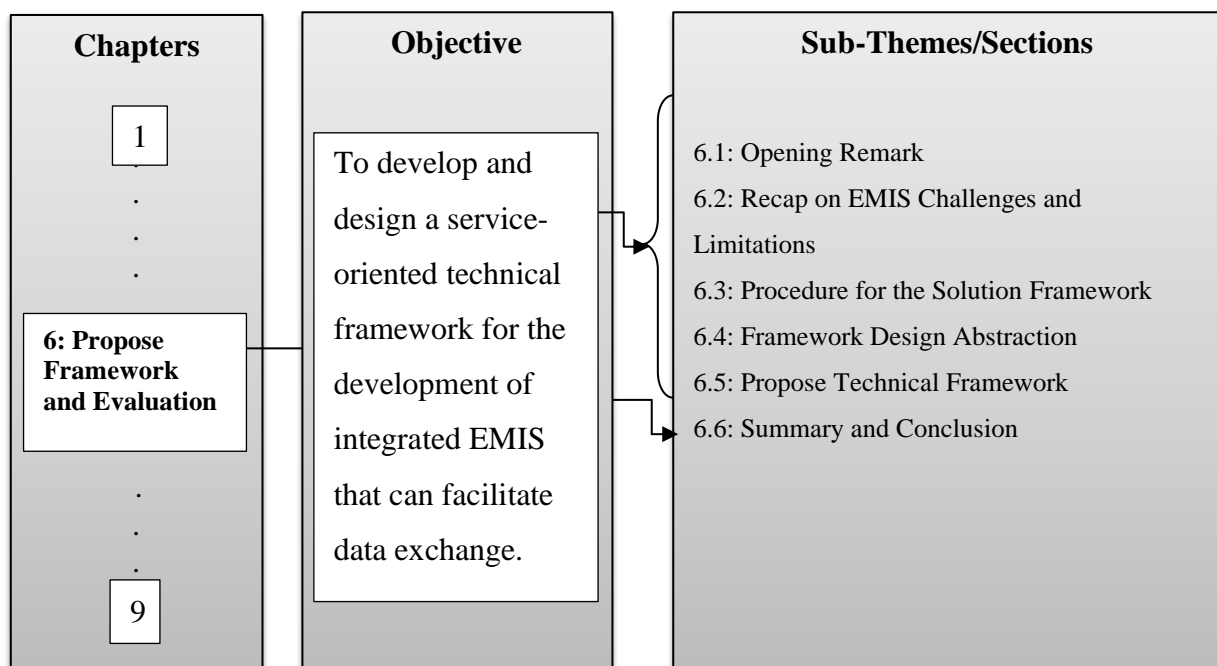

Figure 6.1: Objective Overview of Chapter Six

The Opening Remark subtheme (Section 6.1) re-emphasize the research gap and sets the focus for the proposition of technical framework for the development of integrated EMIS. The subtheme on Recap on EMIS Challenges and Limitations (Section 6.2) re-emphasizes the research gap from literature and findings, review the existing solution approaches, and contextualizes the review of the requirements for the design of framework for the development of integrated EMIS that simplifies data exchange mechanism.



The subtheme on Procedure for the Solution Framework (Section 6.3) describes the procedures and approaches that was adopted in proposing the conceptual and technical frameworks for the development of integrated EMIS that simplifies data exchange across platforms. The Framework Design Abstraction subtheme (Section 6.4) provides for a top-level abstraction of the propose framework using conceptual model that shows the core concepts and the interactions among them.

Meanwhile, the subtheme on Propose Technical Framework (Section 6.5) identifies and discusses the different layers and components of the propose technical framework with emphasis on their technical justifications. The Closing Remark subtheme (Section 7.5) summarizes the discussions in this chapter and provides clarity of arguments to answer the fourth research questions in this study.

## **6.1 Opening Remark**

The benefits and challenges of EMIS are identified and discussed in Chapter 2 Section 2.6 of this thesis. This underscores the significance of EMIS to the management and administration of the education system, especially in the ease and timely processing of education data to generate analytical information that support decision-making process. Meanwhile, the efficiency and effectiveness of EMIS to deliver on its key benefits is limited by the technical complexities in the technology means of providing connections to access, process, exchange, and present data.

The use of standard frameworks like the Education Management Information System Interoperability Framework (EMIF) and the School Interoperability Framework (SIF), as discussed in Chapter 3, Section 3.5 of this thesis, is to standardize the EMIS development and integration process using the conceptual design approach of the Service-Oriented Architecture (SOA).

The SOA is discussed as a form of design approach to EMIS integration in Chapter 3, Section 3.3.2. Meanwhile, the complexity in the underlying technology and implementation of web services has limited its use in developing countries like Nigeria with limited technology support. This is evident in the analysis of the research findings as discussed in Chapter 4, Section 4.5 of this thesis.

This chapter, therefore, demonstrates the solution stage of the Design Science Research Methodology approach to this study as discussed in Chapter 1 Section 1.7.2 of this thesis. The basis is in the use of the arguments from the research findings, as discussed in the preceding Chapter 5 of this thesis, to produce a solution artefact. Artefacts, as outcome of the solution stage in DSRM, from the argument of (Ahmed & Sundaram, 2011), could take the form of a method, construct, or model. For this study, the solution artefact is considered a model that is described as technical framework.

The solution approach considered the use of thematic and inductive analysis, as shown in APPENDIX 4, to conceptualize a simplified design abstraction using a procedure for conceptual framework analysis as a basis to propose a service-oriented technical framework for the development of integrated EMIS. The basis for the conceptual analysis is the elements of the principles and requirements for the development of integrated EMIS, as identified and discussed in the preceding Chapter 5, Section 5.4 and Section 5.5 respectively. This process flow for achieving the design and development of the proposed framework is represented in the Figure 6.2 below.

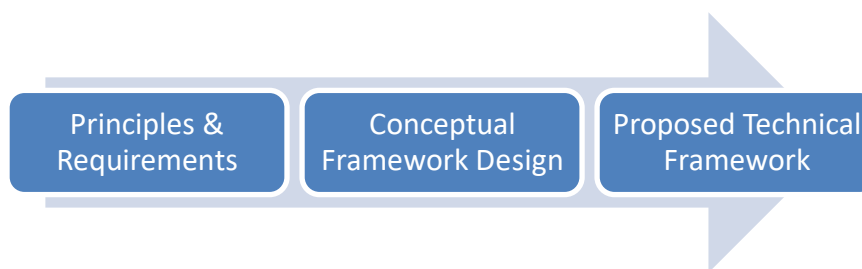

**Figure 6.2: Process Flow for the Proposed Framework Design**

The propose framework is then demonstrated with a single case study approach as argued in Chapter 1, Section 1.7.4 and also evaluated base on the requirements that are identified in Chapter 5 Section 5.5 of this thesis. The case study demonstration and evaluation are discussed in succeeding Chapter 7 and Chapter 8 of this thesis, respectively.

## **6.2 Recap on EMIS Challenges and Limitations**

The design structure of EMIS is argued in the background to this study under Chapter 1, Section 1.1. In this study, EMIS is contextualised as an integrated education support system with functional modules that model solutions for different tasks within the education system; it is developed on a standard framework to ease the process of data exchange across modules and platforms.

The argument is that the design and development of EMIS as an integrated system with functional modules that deliver on different education tasks is a better approach and technical mean of describing integrated EMIS. This also resolves the challenge with the integration of EMIS of different platforms that are used at different levels of the tertiary education institutions in Nigeria. The issues, therefore, remain the understanding of the requirements and conceptualisation of the technique for the design of a technical framework that can drive the development of EMIS as an integrated system that can easily exchange data across its functional modules or other EMIS of different platforms.

This section recaps the issues from the literature and the arguments from research findings to re-emphasise the challenge and research gap to be filled by this study. This is to properly contextualise the research objective.

It further recaps the existing solution approaches and the arguments on the requirements for the proposed framework design that are discussed in Chapter 3, Section 3.5 and Chapter 5, Section 5.5 of this thesis respectively.

The purpose of the recap is to properly contextualise arguments to propose the design of a service-oriented technical framework for the development of integrated EMIS.

### **6.2.1 Connecting Challenges from Literatures and Findings**

EMIS as an education support system for timely collection and reliable processing of education data (Damin, et al., 2014) is described and discussed in Chapter 2 of this thesis. The description of EMIS emphasised its importance in the education system and its deployment at every level of the education institutions.

The need to connect several EMIS at every level of the education system requires integration approach to ensure the seamless exchange of data across platforms. Achieving integration to extend the capabilities of EMIS to exchange data is a major challenge to its development (Sayed, et al., 2016).

However, there is evidence from literature on the use of different technologies and frameworks as standard approaches to resolve the EMIS integration challenge. These standard technologies and frameworks are discussed in Section 3.4 and Section 3.5 of this thesis.

Aside the limitation of the EMIF and SIF frameworks in terms of its use of complex integration technology standards to achieve data exchange, evidence from the research findings establishes the arguments around low level of adoption in developing countries like Nigeria due to low level of awareness and limited technical knowledge on the implementation of standard EMIS development frameworks. These challenges and limitations to the use of standard development framework for EMIS integration in Nigeria are discussed in Section 4.10 of this thesis.

The need for a simplified framework for the development of integrated EMIS to achieve seamless data exchange underscore the main objective of this study, which is to investigate, design, demonstrate and evaluate a service-oriented technical framework for the development of integrated EMIS to achieve seamless data exchange.

### **6.2.2 Solution Approaches**

The solution approach to addressing EMIS integration challenge requires a consideration of the design architecture and the integration technologies. These are respectively discussed in Chapter 3, Section 3.3 and Section 3.4 of this thesis.

The Service-Oriented Architecture (SOA) is discussed as a suitable design approach to building scalable solution that can respond to increasing and changing information requirements of the education system as identified in the research findings.

The context of application is in the use SOA as a design approach to the development of integrated EMIS with data objects that are exposed and consumed as services. These services can be shared and re-used for data exchange using simplified but effective data transportation or serialisation technology.

The implementation of SOA uses standard technologies: Web Services, Semantic Web Services and Web API, as discussed in Chapter 3, Section 3.4 of this thesis, to achieve development of EMIS as an integrated system. Meanwhile, the Web API with light-weight data serialisation technology, like the Java Script Object Notation (JSON), simplifies the implementation technology and the complexities of the data communication and exchange channels in the integrated EMIS.

As observed from the research findings and discussed in Chapter 4, Section 4.8.1 of this thesis, the design architecture of integrated EMIS need to consider the cloud approach to develop EMIS as enterprise solution that can leverage the potential of the internet backbone to integrate

and exchange data seamlessly. The solution approach, therefore, consider the multi-tenancy approach of the cloud system to integrate multiple EMIS as tenants on a cloud platform.

Thus, the scalable design architecture of SOA is applied to the proposed framework using the Web API with JSON as simpler technology for standard development of integrated EMIS that leverage the cloud platform to achieve seamless data exchange.

### **6.2.3 Solution Requirements**

The analysis of the research findings shows twelve (12) principles as guidelines for the design and development of integrated EMIS that ensure seamless data exchange. These principles are highlighted and discussed in Chapter 5 Section 5.4 of this thesis and were further analysed to identify the requirements for the design of a framework for integrated EMIS development.

These requirements are identified in Chapter 5 Section 5.5 as (1) Adaptability to the specific information needs; (2) Maintainability of the EMIS structure; (3) Standardisation of the technologies and techniques; (4) Scalability to extend functionalities; (5) Connectivity of the different data sources; and (6) Accessibility to cross-platform data for presentation. These requirements also represent the metrics for validating and evaluating the proposed framework.

It is, however, noteworthy that design requirements describe the functionality, behaviour and structure of the solution (Linden, et al., 2010; Carroll & Richardson, 2016), which fits into a customisable model that addresses the goals, skills and preference of the users (Hui, et al., 2003). Linden *et al* (2010) argued further that the basis for the design requirements has considerations for such factors as testability, modularity, maintainability, and usability of this system. These factors agree with the requirements that are identified from the research findings.

### **6.3 Procedure for the Solution Framework**

The solution approach for this study focuses on using conceptual analysis to model an abstraction of a conceptual framework to gain insight into the technical details for the development of integrated EMIS that simplifies communication channels for seamless data exchange.

The building blocks of conceptual framework analysis are the concepts, which are interconnected to form a conceptual framework that provides better understanding of a phenomenon and with each concept having specific function that is defined by its components

(Jabareen, 2009; Tamene, 2016). The conceptual framework analysis as argued by Jabareen (2009) is based on grounded theory using the inductive approach of generating concepts from analysis of data and becomes essential for this solution approach because of its flexibility of allowing the researcher to construct conceptual framework to explain phenomena from findings (Tamene, 2016).

Contextualising the procedure for conceptual framework analysis by Jabareen (2009) within the inductive approach, this study adopts the following procedures to design the conceptual framework leading to the design of the technical framework for the development of integrated EMIS:

- **Step 1:Data Mapping**

This involves mapping and categorisation of the identified principles and requirements for the design and development of integrated EMIS as identified from the analysis of the research findings.

- **Step 2:Concept Identification**

This involves a review of the categorised themes to inductively identify phenomena that can be modelled as concepts with its descriptive attributes or dependencies. Each concept is derived and connected to another concept.

- **Step 3:Concept Integration**

This involves grouping and integrating related concepts to identify broader concept that is more descriptive to capture the greater idea of the related concepts with the development of integrated EMIS.

- **Step 4:Framework Design Synthesis**

Identified concepts are connected by relationships to build a flow of interconnected concepts that model a conceptual framework.

- **Step 5:Technical Review**

This involves a review of each of the concepts and attributes in step 4 to raise technical arguments to represents the idea in each block of the conceptual framework.

- **Step 6: Technical Thematic**

This requires the inductive representation of the technical arguments that are raised in step 5 to raise technical themes and subthemes.

- **Step 7: Synthesis and Analysis**

Explanation is given for the flow of arguments in the technical themes with supporting arguments from literature and findings.

It is noteworthy that the activities in step 1 to step 4 provide the basis for a design abstraction of the solution framework, which is discussed in Section 6.4 of this thesis. Meanwhile, step 5 to step 7 detail the activities leading to the design of the technical framework, as discussed in Section 6.5.

#### 6.4 Framework Design Abstraction

Lindn, Onarheim & Christensen (2010) argued that there is an interplay between the design requirements and the solution approach. The basis is that solution approach involves structured design organisation using modular approach that interconnect basic concepts to develop an increasing design detail.

Meanwhile, Jabareen (2009) argued that the identification and integration of the concepts “represent practices that are related to the phenomenon”. This emphasizes the inductive approach that is adopted in the design process. The design follows the fundamental characteristics of a concept as phenomena that is interconnected by a relation and originated from one another with components that describe its functions and behaviours (Jabareen, 2009; Tamene, 2016).

The analytical process leading to the identification of the concepts and components is represented in the APPENDIX 4. Five (5) concepts were identified with descriptive components; one of which describes the point of connection with other concepts. The excerpt from APPENDIX 4 is represented in the Table 6.1 below. This shows the connection the concepts, components and the related principles that informed the concepts.

Table 6.1: Conceptual Framework Analysis for Integrated EMIS Development

Concept	Components	Underlying Principles
Requirement Analysis	+ understanding design approach and its complexity  + recognising the needs and peculiarities of universities	<b>Principle 1:</b> Identify the Information Needs of the Education Institution  <b>Principle 2:</b>

	<ul style="list-style-type: none"> <li>+ planning and assessing implications of adopted approach</li> <li>+ approach is limited by technical know-how</li> </ul>	<p>Set-up and organise the EMIS Development Team</p> <p><b>Principle 3:</b> Enhance the Technical Know-how of the EMIS Developers</p>
Design Structure	<ul style="list-style-type: none"> <li>+ standard design framework.</li> <li>+ update design with changes in requirements</li> <li>+ scalable and integrated modular design.</li> <li>+ limited by technical know-how;</li> </ul>	<p><b>Principle 4:</b> Chose the Design Architecture for EMIS Implementation</p> <p><b>Principle 5:</b> Adopt a Design Standard</p> <p><b>Principle 9:</b> Define Endpoints and Re-Usable Methods for Data Exchange</p> <p><b>Principle 10:</b> Make Provision for New Information Needs and Plugins</p>
Development Approach	<ul style="list-style-type: none"> <li>+ planning the approach to development activity.</li> <li>+ update changes in design and requirements</li> <li>+ development platform that fit the requirements.</li> <li>+ consider integration technology in development process;</li> </ul>	<p><b>Principle 8:</b> Adopt a Standard Programming Logic for EMIS Development</p>
Integration and Exchange Mechanism	<ul style="list-style-type: none"> <li>+ mechanism for data processing and control.</li> <li>+ defining channels for data exchange.</li> <li>+ data format and exchange across modules.</li> <li>+ considerations for the technical complexity;</li> </ul>	<p><b>Principle 6:</b> Choose the Standard Data Format for Information Exchange</p> <p><b>Principle 7:</b> Ensure EMIS Gain Access to Shared Database</p> <p><b>Principle 11:</b> Collect and Store Data from Multiple Data Sources</p>



Data Storage System	+ data structures and architecture + data processing and exchange + data processing and connections to storage system;	<b>Principle 12:</b> Present Data in Format that Support Decision-Making
---------------------	------------------------------------------------------------------------------------------------------------------------------	-----------------------------------------------------------------------------

The connections among these concepts are presented in a design abstraction that is modelled from the conceptual framework analysis using data extract from the research findings. This

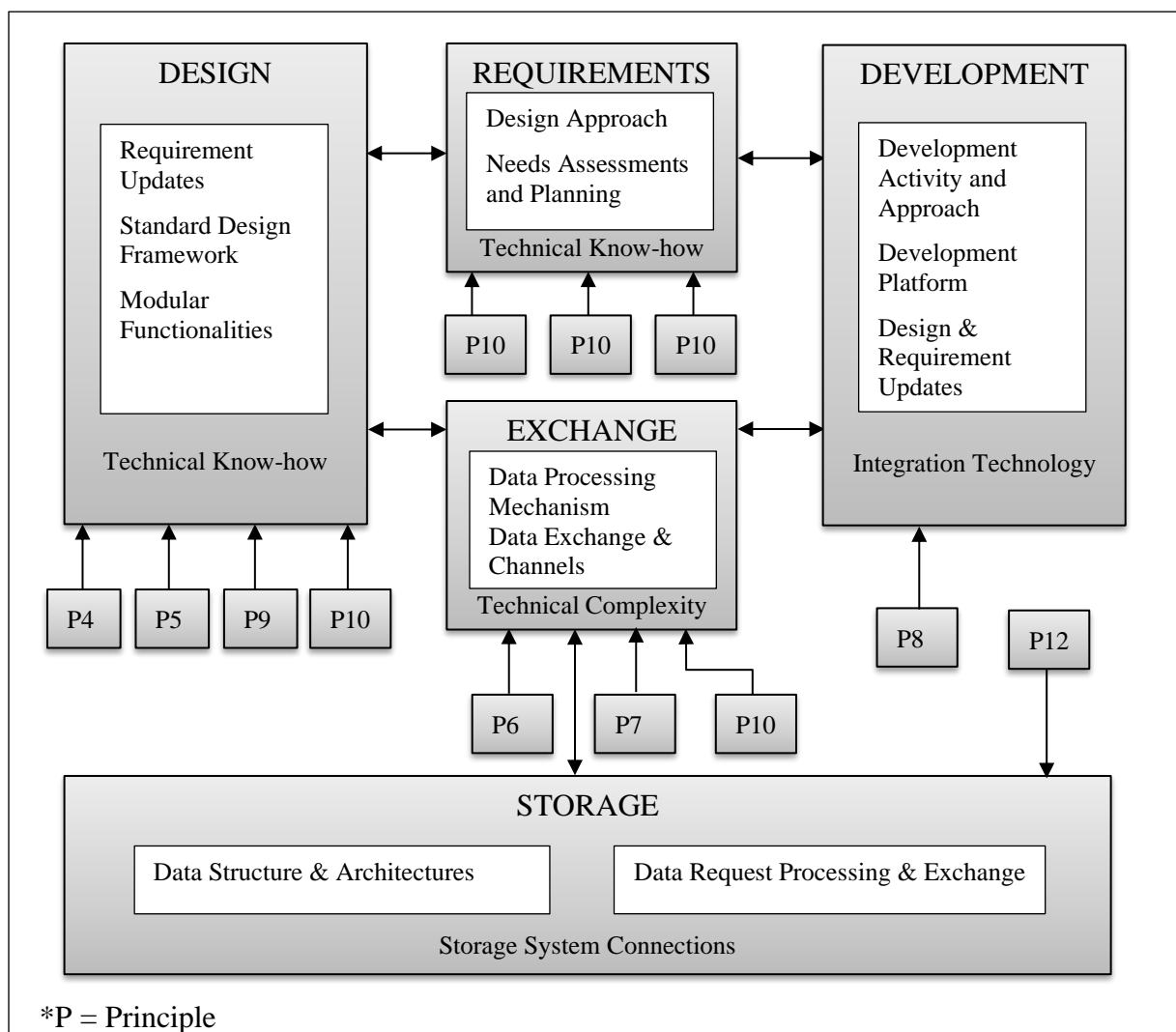

Figure 6.3: Conceptual Framework for Integrated EMIS Development

conceptual framework, as shown in Figure 6.3 above, models the interconnection of related concepts, which are relevant to the design of framework for the development of integrated EMIS that simplifies the challenge of data exchange. The design abstraction of interconnected concepts and relations is described thus:

The Requirement Analysis concept aggregates the needs and peculiarities of the education institution and identify standard approach and development platform to model Design Structure and Development Approach for EMIS. This is limited by the consideration for planning and the technical know-how of the development team.

The Design Structure concept also recognises the need for personalisation of the design approach for representation of the requirements of each education institution and adopts a modular functionalities design approach that accommodate changes to make requirement updates. This is also limited by considerations for development team's technical know-how.

Meanwhile, the Development Approach concept also recognises the need for planning for an appropriate development platform that accommodates requirement update in design structure and requirements of each education institution. This requires consideration for integration technology for the development of integrated functional modules.

The Integration and Exchange concept provides for a data processing mechanism and data exchange channels to handle requests and endpoints for data exchange among the modular functions. This requires consideration for standard data exchange technology to handle the technical complexity in the mechanism for data exchange. The data exchange is focused on the horizontal integration approach of extending service across functional modules.

The Data Storage System concept define the data structure and architecture of the data elements in EMIS and provides for the technicalities for handling data request processing and exchange. This requires technical consideration for the description of connections to the database system to respond to data requests.

As argued in the Section 6.3 - Procedure for the Solution Framework, the design abstraction for the solution framework, as modelled in the conceptual framework, is a basis to propose the design of a technical framework for the development of integrated EMIS that simplifies the challenge of data exchange.

## **6.5 Proposed Service-Oriented Technical Framework**

Further analysis of the identified concepts with inductive approach that focuses on technical review considerations, produces five (5) technical themes for consideration in the design of service-oriented technical framework for the development of integrated EMIS, as shown in

APPENDIX 4. The diagrammatic representation of the processes leading to the proposed framework from the analysis of the conceptual framework is presented in the Figure 6.4.

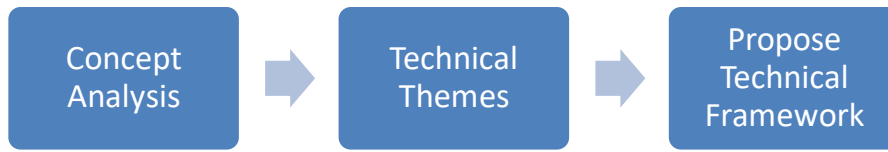

Figure 6.4: Connecting the Conceptual Framework to the Proposed Framework

The proposed technical framework, as shown in the Figure 6.5 below, provides technical meaning and arguments for the demonstration of the ideas and phenomena in the technical themes. The interaction among the technical themes is the basis for the design of the proposed technical framework. The technical themes are discussed in the following subsections.

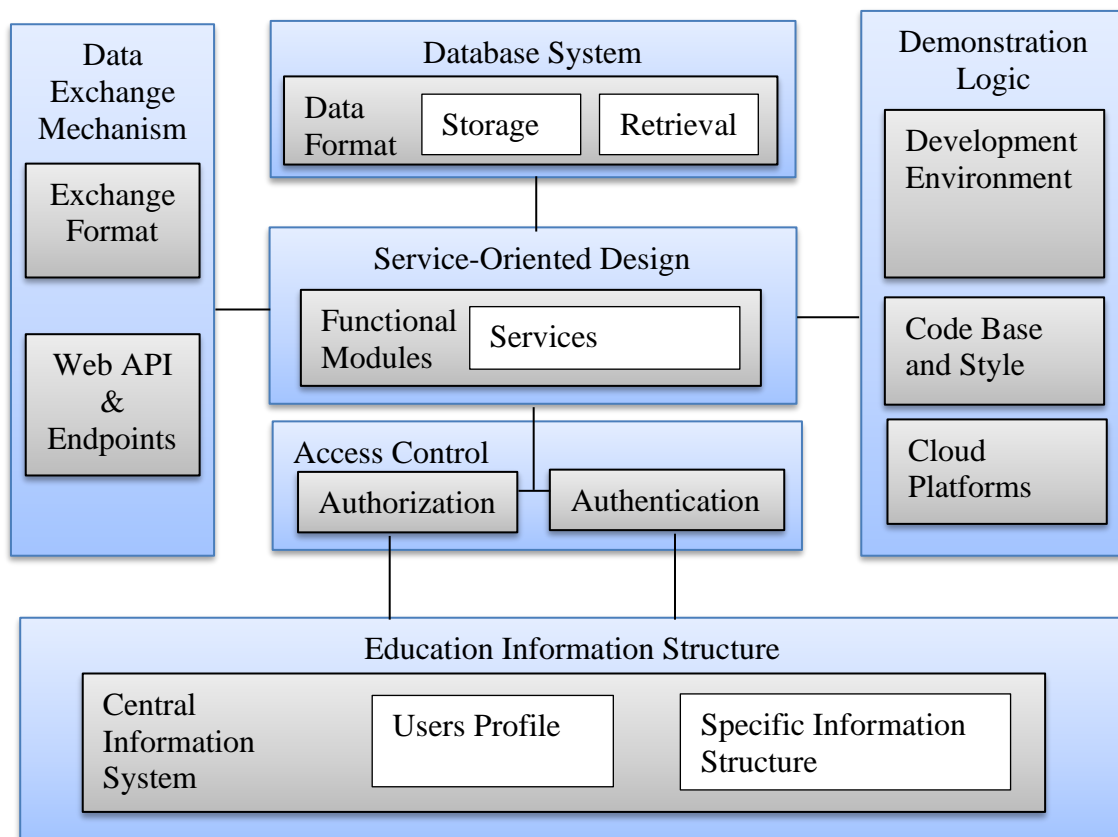

Figure 6.5: Integrated EMIS Development Framework

### 6.5.1 Education Information Structure

The Education Information Structure component of the proposed framework relates to the design principles and requirements for the development of integrated EMIS as analysed in APPENDIX 4 and the excerpt is represented in the Table 6.2.

**Table 6.2: Education Information Structure Component of the Proposed Framework**

<b>Framework Component</b>	<b>Principles</b>	<b>Requirements</b>
Education Information Structure	<p align="center"><b>Principle 1:</b> Identify the Information Needs of the Education Institution Developers</p>	Adaptability
	<p align="center"><b>Principle 2:</b> Set-up and organise the EMIS Development Team</p>	Maintainability
	<p align="center"><b>Principle 3:</b> Enhance the Technical Know-how of the EMIS Developers</p>	

The education system, especially at the tertiary segment, is a structured environment with levels and layers of communication, processes and procedure for information flow and exchange, as discussed in Chapter 2, Section 2.2 of this thesis. Across education segments, the process and procedure of information processing differ with respect to their local peculiarities and needs. These peculiarities require a design approach that is adaptable and ensure the privacy of data of the different education systems.

The adaptability requirement is emphasised in Chapter 5 Section 5.5.1 and Section **Error! Reference source not found.** of this thesis, respectively. However, the choice of the design approach, as discussed in Chapter 3 Section 3.3, requires assessment of its implications and it is limited by the technical know-how of the EMIS developers. Thus, the development of integrated EMIS requires a structured design of the education information structure that is adaptable to the local information requirements and a database system that ensure the privacy of data of the different education segments.

In essence, the information structure requires a critical planning and assessment of the education system to identify and classify distinguishing education information requirements. These are identified as design principles for integrated EMIS development in Section 5.4.1, Section 5.4.2 and Section 5.4.3 of this thesis.

The collection of common requirements is aggregated to form the Central Information System (CIS) that describes the general information structure of the education system. These general information requirements include user management, authentication and authorisation, among others.

Meanwhile, other requirement differentials are defined as extensions of the CIS with provisions for interfacing layers that aggregate requirements for personalising the integrated EMIS environment to recognise local peculiarities and needs. The CIS provides a structural measure for ease of maintenance of the integrated EMIS, which is a requirement for integrated EMIS development as discussed in Section 5.5.2 of this thesis.

Meanwhile, a layer of Access Control (AC) is integrated in the EIS to ensure relative security and control of access to modules at the CIS and the extended functional modules. The AC is handled by a layer of authentication and authorisation modules at the EIS.

### 6.5.2 Service-Oriented Design

The Service-Oriented Design component of the proposed framework relates to the design principles and requirements for the development of integrated EMIS as analysed in APPENDIX 4 and the excerpt is represented in the Table 6.3

**Table 6.3: Service-Oriented Design Component of the Proposed Framework**

<b>Framework Component</b>	<b>Principles</b>	<b>Requirements</b>
Service-Oriented Design	Principle 4: Chose the Design Architecture for EMIS Implementation	Standardisation
	Principle 5: Adopt a Design Standard	
	Principle 9:	

	Define Endpoints and Re-Usable Methods for Data Exchange	Scalability
	Principle 10: Make Provision for New Information Needs and Plugins	

The multi-level structure of the education system requires a design approach to integrated EMIS development that deconstruct the complexity of the information flow across several levels: each with its own information requirements. These are discussed in Section 2.2 and Section 4.5 of this thesis.

The standard design approaches can either take the form of Service-Oriented Architecture (SOA) or Enterprise Application Integration (EAI) as discussed in Chapter 3 Section 3.3. The SOA, as a design approach, is much appropriate for integrated EMIS development because of its loose coupling nature of services that drive the functional modules of integrated EMIS. This allows for scalability that extends interfaces for connecting and exchanging data across extensible modules using standard technology approach. The standardisation and scalability requirements in integrated EMIS development are emphasised in Chapter 5 Section 5.5.3 and Section 5.5.4 of this thesis.

Using SOA as standard design approach, the framework for integrated EMIS development considers functional education tasks like admission or enrolment, registration, payment, e-learning, result processing or grading as scalable EMIS modules that can be bundles of services with interfaces for connecting and exchanging data across other modules.

The design principle for integrated EMIS development that consider each education task as functional EMIS module is discussed in Chapter 5 Section 5.4.4 and Section 5.4.5 of this thesis. Each functional EMIS module, developed with integrated and interacting services, is connected with the Central Information System (CIS) to access and exchange common EMIS data for local manipulation using foreign connection key.

The design principles that emphasise the provision of interface to extend functional modules and make provisions for new information requirements are provided for in the Chapter 5 Section 5.4.9 and Section 5.4.10 of this thesis.

### 6.5.3 Demonstration Logic

The Demonstration Logic component of the proposed framework relates to the design principles and requirements for the development of integrated EMIS as analysed in APPENDIX 4 and the excerpt is represented in the Table 6.4.

Table 6.4: Demonstration Logic Component of the Proposed Framework

<b>Framework Component</b>	<b>Principles</b>	<b>Requirements</b>
Demonstration Logic	Principle 8: Adopt a Standard Programming Logic for EMIS Development	Standardisation

Understanding the domain specific information requirements and modelling appropriate design approach for the demonstration plan are precursor activities to the development of integrated EMIS. These are emphasised in the Chapter 5 Section 5.4.1 and Section 5.4.4 of this thesis.

The demonstration process extends the service-oriented design approach to leverage the cloud platform in re-contextualizing the integration of EMIS from the perspective of multi-tenancy that delivers EMIS platform as a service. The multi-tenancy approach ensures that several instance of EMIS are integrated to co-exist on the same platform while ensuring personalisation of the environment, to suit the specific information requirement of each education institution, is maintained.

This multi-tenant cloud approach of implementing integrated EMIS development reduces the administrative and technical challenge of maintaining the EMIS, which is a requirement that is discussed in Chapter 5 Section 5.5.2 of this thesis.

The demonstration of the EMIS development logic also considers the development environment, such as the consideration for web platform using Rapid Application Development Environment as discussed in Chapter 2 Section 2.5.5 that bridge the limitation of the end-user's technical know-how, as discussed in Chapter 5 Section 5.4.3, to deliver solution with code base and style that ensure re-usable and maintainable programming logic.

The code base or programming style also consider the tiered design architecture of the integrated EMIS that separates the EMIS structure into layers of programming constructs. This standard programming approach to integrated EMIS development is a requirement that is discussed in Chapter 5 Section 5.5.3 of this thesis.

The simplicity of the demonstration logic, as a principle that is discussed in Chapter 5 Section 5.4.8, is hinged on the interpretation of the scalable design to deliver programming logic for integrated and interacting services with capability for seamless data processing and exchange. The integration approach to connecting services through interfaces is hinged on web Application Programming Interfaces (Web API) as discussed in Chapter 3 Section 3.4.3 of this thesis.

#### 6.5.4 Data Exchange Mechanism

The Data Exchange Mechanism component of the proposed framework is connected with the design principles and requirements for the development of integrated EMIS as analysed in APPENDIX 4 and the excerpt is represented in the Table 6.5.

**Table 6.5: Data Exchange Mechanism Component of the Proposed Framework**

<b>Framework Component</b>	<b>Principles</b>	<b>Requirements</b>
Data Exchange Mechanism	<b>Principle 6:</b> Choose the Standard Data Format for Information Exchange	Standardisation
	<b>Principle 7:</b> Ensure EMIS Gain Access to Shared Database	Connectivity
	<b>Principle 11:</b> Collect and Store Data from Multiple Data Sources	

Processing and exchanging data across scalable and interacting services requires the use of standard data format to transport data through secured communication channels. This is to ensure that communication and data exchange is only established between two connecting endpoints.



The mechanism and standard format for data exchange are discussed in Chapter 2 Section 2.5.2 and Section 2.5.3 respectively with the arguments that the use of Java Script Object Notation (JSON) and Extensible Mark-up Language (XML) are two common standard technologies to serialise data for connecting two endpoints; JSON being much appropriate for internal data exchange among functional modules and XML used for external data exchange with third party applications.

Ensuring connectivity across endpoints using standardized technologies are design requirements for integrated EMIS development. These requirements are discussed in Chapter 5 Section 5.5.5 and Section 5.5.3 of this thesis respectively.

Using the Web API approach to the development of interacting services in the functional module design of integrated EMIS, data exchange is through a channel of data transportation and communication that is established between two endpoints. To push data through the channel, such data is serialised in a standard format that is chosen and understandable by the two connecting endpoints. The choice of appropriate serialisation format for exchanging data across endpoint and the mechanism for ensuring access to shared data sources are guiding principles for development of integrated EMIS that are discussed in Chapter 5 Section 5.4.6, Section 5.4.7 and Section 5.4.11 of this thesis.

In essence, endpoints are defined for each service within the functional module of integrated EMIS with interface to transport and communicate data exchange in JSON format. This is discussed as a design principle for integrated EMIS in Chapter 5 Section 5.4.9 and the logic makes provision for extension of modules or services for new requirements. The provision for new requirement is identified and discussed in Section 5.4.10 of this thesis.

### **6.5.5 Database System**

The Database System component of the proposed framework relates to the design principles and requirements for the development of integrated EMIS as analysed in APPENDIX 4 and the excerpt is represented in the Table 6.6.

**Table 6.6: Database System Component of the Proposed Framework**

<b>Framework Component</b>	<b>Principles</b>	<b>Requirements</b>
----------------------------	-------------------	---------------------

Database System	<b>Principle 12:</b> Present Data in Format that Support Decision-Making	Accessibility
-----------------	--------------------------------------------------------------------------------	---------------

In alignment with the multi-tenant cloud approach to the design structure and demonstration logic of integrated EMIS development, each instance of the EMIS for each institution maintains separate tenant database. However, there is a shared database structure that connects with the CIS in the EIS component of the proposed framework. The shared database maintains common data entities across the integrated EMIS and its functional modules.

Meanwhile, the central focus of EMIS is the collection, processing, analysis, and presentation of cross-platform data. These data are formatted and stored in repositories where requests for storage and retrieval is handled. The representation of the data for storage and retrieval, within the context of its type, form, and model is discussed in Chapter 2 Section 2.5.1 of this thesis, with the argument that all forms and types of data can be manipulated and stored in the database or storage system.

The representation of data in structured format enhances the connectivity and access for processing requests to store or retrieve data, which in turn ease the processes of achieving data exchange in integrated EMIS. While the requirement for accessibility, as discussed in Chapter 5 Section 5.5.6 of this thesis, relates to analysis and presentation of data, the connectivity requirement, as discussed in Chapter 5 Section 5.5.5 of this thesis, relates to the collection and processing of cross-platform data.

The Web API is designed to request data from the storage system and reformat in serialised format for exchange. The need to have the Web API to gain access to the shared database and present in format that can support decision-making process is identified and discussed as a design principle for integrated EMIS development in Chapter 5 Section 5.4.12 of this thesis. Meanwhile, all forms of EMIS data are refined as structured data for storage in the shared database. Typically, the storage system is managed by a relational database management system.

## 6.6 Closing Remark

This chapter re-emphasised the issues from the literature and research findings to contextualise arguments for the proposition of technical framework for the development of integrated EMIS.

These issues re-emphasised the data exchange challenges with EMIS integration and the limitation of the existing EMIF and SIF frameworks. It also re-examined and argued the solution approach of considering the SOA as a design approach with Web Service API as integration technology approach to develop integrated EMIS that aligns with the identified principles and requirements for integrated EMIS development as argued from the findings in this research study.

This chapter raised arguments on the procedure for the solution approach to the design of a framework for the development of integrated EMIS and provide basis to answer the fourth research question in this study:

**iv. How can a service-oriented technical framework for the development of integrated EMIS be developed and designed?**

To answer this research study question, the procedure for conceptual framework design by Jabareen (2009) was adapted to design an abstraction of the solution framework. This is based on further analysis of the design principles and requirements for the development of integrated EMIS to identify five (5) inter-connected concepts and corresponding components using inductive reasoning approach. The relationships among these concepts: Requirements Analysis, Design Structure, Development Approach, Integration and Exchange, and the Storage System were used to design the conceptual framework that provides an abstraction for the technical framework.

Inductive approach is used to further review the components of the inter-related and inter-connected concepts to identify the technical considerations for the proposed technical framework for the development of integrated EMIS. The technical framework identifies five (5) thematic components of a service-oriented technical framework for the development of integrated EMIS that uses simplified techniques and technologies for data exchange.

These thematic are: Education Information Structure that emphasised the Central Information System (CIS) for handling the common information requirements in the education system; Service-Oriented Design that emphasised the SOA design approach to connecting functional EMIS modules with the CIS; Demonstration Logic that considered the use of multi-tenant cloud approach with Web API as programming style and logic for the development of integrated EMIS; Exchange Mechanism that consider the use of light weight JSON as

mechanism for data exchange by the Web API; and the Database System that consider the use of shared database management system for data storage and retrieval.

Then, the key research contributions are in the provision of the CIS with customization that makes the proposed framework adaptable and the cloud platform approach that simplified integration and data exchange with same platform for different education system. The proposed technical framework is demonstrated using a single case study approach as discussed in the next Chapter 7.

## CHAPTER 7 : FRAMEWORK DEMONSTRATION WITH A CASE STUDY

This chapter demonstrates the proof-of-concept and demonstration of the proposed framework as a basis to partly answer the fifth research question in this study:

- v. **How can the proposed framework for the development of integrated EMIS be demonstrated and evaluated?**

The arguments for the case study demonstration are organized into sections under this chapter and is represented in the Figure 7.1.

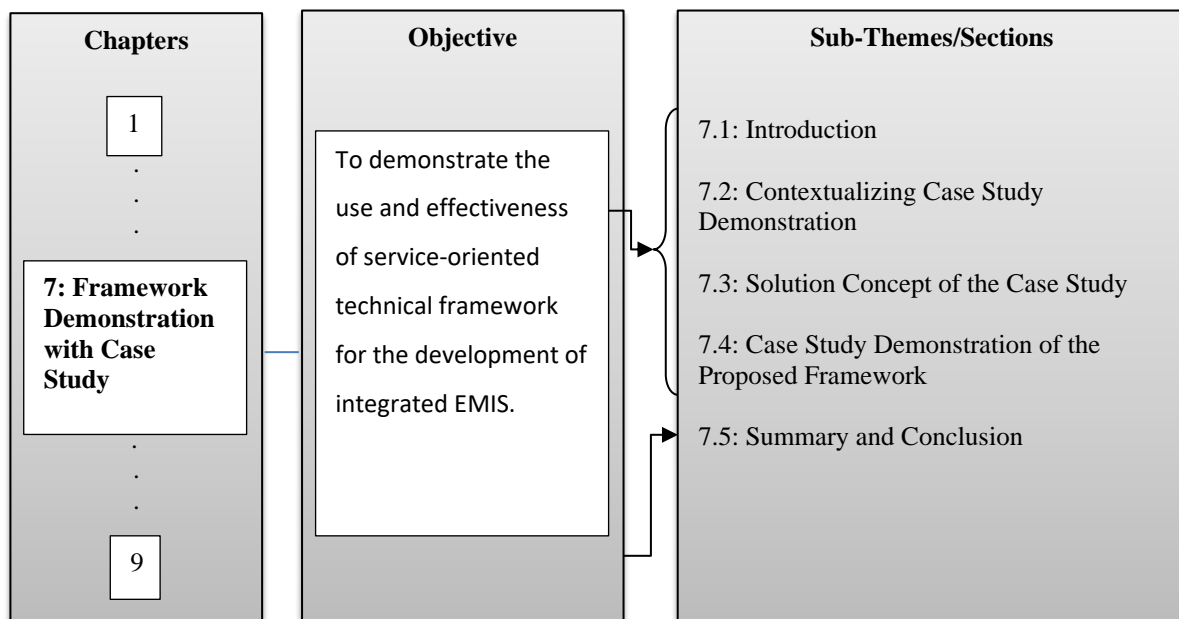

Figure 7.1: Objective Overview of Chapter Seven

The Opening Remark subtheme (Section 7.1) contextualizes the significance of case study and analysis of expert review to the demonstration and evaluation of the proposed technical framework for the development of integrated EMIS. Meanwhile, the subtheme (Section 7.2) on Contextualizing Case Study Demonstration describes the approach and procedure for the demonstration of the proposed framework in the case study environment. The Solution Concept for the Case Study subtheme (Section 7.3) describes the top-level conceptual design approach to the development of the integrated EMIS using the proposed framework.

Meanwhile, the subtheme (Section 7.4) on Case Study Demonstration of the Proposed Framework describes the demonstration of integrated EMIS development with case study approach using the proposed service-oriented technical framework. The Closing Remark

subtheme (Section 7.5) summarizes the arguments in this chapter to articulate the case study demonstration of the proposed framework.

## **7.1 Opening Remark**

The case study approach that is based on constructivism approach of aligning perspectives from the interaction between researcher and participants (Baxter & Jack, 2008) in an environmental context (Ridder, 2017) is applied for this study.

The case study approach that is based on constructivism approach of aligning perspectives from the interaction between researcher and participants (Baxter & Jack, 2008) in an environmental context (Ridder, 2017) is applied for this study.

This is to demonstrate the proposed technical framework for the development of integrated EMIS in tertiary education institution context. The significance of the case study approach as basis for the choice of the demonstration environment is emphasised and discussed in Chapter 1 Section 1.7.4 of this thesis.

This chapter, therefore, re-examined and contextualised arguments on the case study approach for the framework demonstration. Further arguments are raised with conceptual and technical details for the case study demonstration of each component of the proposed framework.

## **7.2 Contextualising Case Study Demonstration**

For purpose of demonstrating the proposed framework in tertiary education system, this study demonstrates the case study approach by identifying a sample educational institution that can be used for the demonstration exercise. The five (5) components of the proposed technical framework is demonstrated as discussed in Section 7.4.

The Tai Solarin University of Education (TASUED), Nigeria is considered for the single case study. The justification for the case study and the choice of TASUED is discussed in Chapter 1 Section 1.7.4 of this thesis.

The TASUED was established on 29<sup>th</sup> January 2005 and operates a collegiate system with five (5) Colleges that run different academic programmes. The University is the 1<sup>st</sup> specialised university of education in Nigeria and the 76<sup>th</sup> university to be recognised by the Nigeria's National University Commission (NUC).

The NUC is an agency of the Nigerian Government that coordinates and set academic standards for universities in Nigeria (NUC, 2019). Hence, the use of TASUED as a single case study for demonstration and evaluation of the proposed framework in this study is adequate and negate the argument of non-generalisation drawback of case study approach by Marczyk, DeMatteo, & Festinger (2017).

The TASUED has an established Information and Communication Technology (ICT) Centre with the mission:

*“To support the University Community with cutting-edge information and communication technology solutions and initiatives that is engineered by our highly resourceful and well-motivated staff through continuous research in education services that promotes qualitative teaching and learning”* (ICT, 2021).

The ICT Centre is managed by a Director of ICT and other application programmers as members of staff that work on the EMIS design, development, and deployment for the use of the University. This further makes it an ideal environment for demonstration of the proposed framework.

### 7.2.1 Justifications for the Case Study Environment

A review of the existing architecture of the EMIS structure at the case study environment, as represented in Figure 7.2, showed that there are portlets of EMIS for different education tasks.

Significant among these EMIS are: Admission EMIS for managing students’ enrolment process; Registration EMIS for managing student course registration; Bursary EMIS for

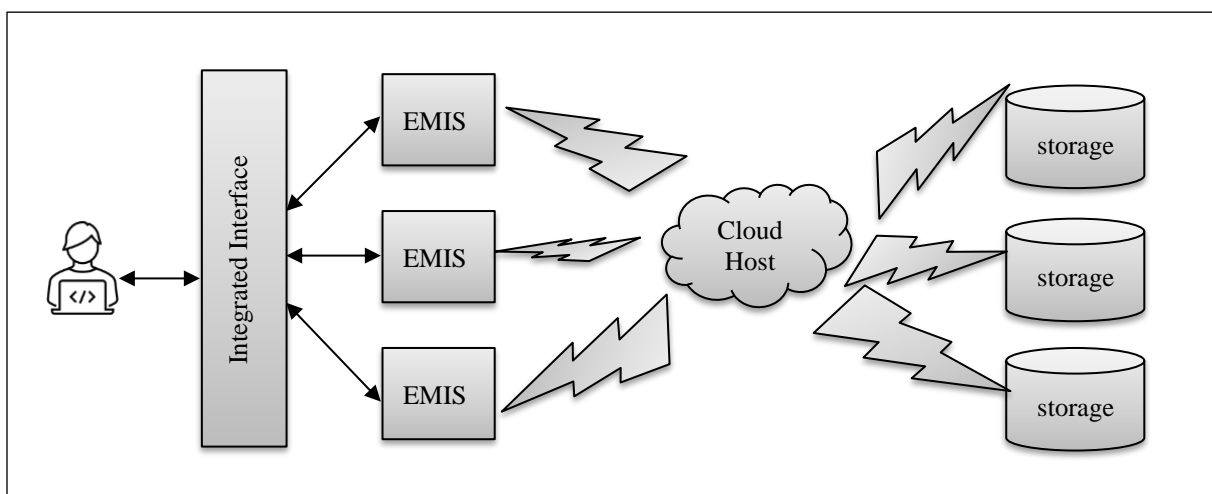

Figure 7.2: Existing EMIS Structure of the Case Study Environment

managing students' payment of scheduled fees; Result EMIS for processing and managing student academic records. These EMIS are hosted on the cloud platform with separate databases for managing the storage system. Users' access to these EMIS is through an integrated web interface that connects the several EMIS together. Data exchange across the several EMIS is through a process of data download from an EMIS, processing with spreadsheet application and upload to another EMIS.

The EMIS structure of the case study lacks proper integration technique that can facilitate seamless data exchange. This further make the case study more appropriate for demonstration of the proposed framework.

Interestingly, the Director of the ICT Centre, during the discussion session in his office on seeking consent for the case study demonstration, shared the view and desire of the University to redesign the institution's portlets of different EMIS to extensively drive and enhance the administration of key education tasks in line with the ICT Centre objective. This provides context for accessing the University for the single case study demonstration.

### **7.2.2 Demonstration Approach and Procedure**

The demonstration of the proposed framework is based on participatory design process to ensure that the development of the integrated EMIS meets the requirements of the education institution. In line with the desire of the case study environment to redesign the existing solutions, the Director of ICT selected five (5) of the technical staff of the University's ICT Centre to join the researcher in the demonstration of the proposed framework to develop new integrated EMIS to allows seamless data exchange. The demonstration process was a six (6) months exercise at the University ICT Centre.

To ensure standard development process, the design principles for the development of integrated EMIS framework, as discussed in Chapter 5 Section 5.4, was adopted for the case study demonstration approach. This is in line with the stages in software implementation process, as argued by (Chotisarn & Sanpote, 2017), which identified the stages as: Software Implementation Initiation; Software Requirement Analysis; Software Architectural and Detailed Design; Software Construction; Software Integration and Test; and Product Delivery.

For purpose of clarity, this study adopted the following step for the demonstration of the case study:



- **Step 1 - Planning for the Demonstration:**

This step involved the initiation of contact with the TASUED ICT Centre to seek consent to use the institution for the demonstration of the proposed framework. Access was granted with the release of technical staff to join in the demonstration exercise.

- **Step 2 - Requirement Analysis:**

This step involved a critical review of the existing EMIS structure and capturing of the information requirements of the case study environment to model a standard design for integrated EMIS that can meet the objective of the institution.

- **Step 3 - EMIS Design Structure:**

The information requirements of the case study were used to model a SOA design architecture for the integrated EMIS in line with the proposed framework. A clarity of the flow of the Central Information System (CIS) was designed for demonstration of the Education Information Structure (EIS) component of the proposed framework. The choice of the cloud approach was considered in the design considerations.

- **Step 4 – Coding on the Development Platform:**

This step involved the use of rapid development environment, as a web development platform, to initiate the development process of the integrated EMIS. The coding activities of adding logic control to the integrated EMIS design was conducted with this step, using object-oriented programming language with Model-View-Controller coding style.

- **Step 5 – Testing the Integrated EMIS with the Case Study:**

This step involved the deployment of the integrated EMIS demonstration on the local server of the case study to test with real data that was generated in the education institution. This step was repeated for five (5) times to ensure that the behaviour of the integrated EMIS solution is as expected when fed with data.

In essence, these five (5) steps represent the procedures and stages that were undertaken in the course of the case study demonstration of the proposed framework. The alignment of the steps with the identified guiding principles from the research finding were further discussed in the succeeding section under the demonstration of the activities in each component of the proposed framework.

### 7.2.3 Development Platform

The case study demonstration of the proposed framework requires a development platform to ease the development process of the integrated EMIS. The significant consideration of the development platform, programming language and technologies, design architecture and data handling to EMIS development process is discussed in Chapter 2 Section 2.5 of this thesis.

The Laravel framework is considered as the development platform for the case study demonstration. It is an open-source environment and framework for web development using PHP programming language for logic control and MySQL as relational database to handle data storage (Laaziri, et al., 2019).

The development platform has extensive libraries of re-usable methods to aid rapid development of web applications on a tiered architecture with Model-View-Controller (MVC) approach that layer web development into three tiers for page presentation with view, programming logic with controller and model for database system.

The Laravel framework is implemented on development approach that make available several tools and services to ease and standardise development process. These technical tools and service are used in the case study demonstration and are described, with the context of its usage, in the Table 7.1 below.

Table 7.1: Laravel Technical Tools and Service

<b>Services &amp; Tools</b>	<b>Description</b>
Restful API	A Representational State Transfer (REST) Application Programming Interface (API) that uses the HyperText Transfer Protocol (HTTP) request to access and consume data using the GET, POST, PUT and DELETE functions to respectively read, update, create, and delete data object.
Router	An expressive method of defining Universal Resource Identifier (URI) path to an application resource location, which may be used along with the GET, POST, PUT and DELETE functions to direct or redirect HTTP requests.

Controller	A method or class that accepts incoming request to process the business logic of an application by manipulating data in the model and rendering the result to the view.
Function	A unit of actionable method of a controller that can be used or re-used to execute a part of the business logic of the application.
Middleware	A mechanism or method of filtering and authenticating incoming requests before execution.
Service Handler	A service container that is used to manage dependencies among services and trigger action or event in a service base on conditions that is set within another service.
Query Builder	An interface in Laravel for creating and executing database queries.
Cache	A mechanism or method of storing frequently used data in a temporary storage to improve response performance.
Seeder Function	A class or function with a method of inserting data into the database.
Migration Function	A method of creating and dropping tables in a database from the Laravel environment.

The application of these technology tools to the demonstration of the techniques for the development of integrated EMIS at each component later of the proposed framework are discussed in the succeeding Section 7.4.

### **7.3 Solution Concept for the Case Study**

As discussed in the Section 7.2.1 on the review of the existing EMIS structure of the case study environment, there is the need to re-design the EMIS structure to integrate the portlets of EMIS applications. This section, therefore, conceptualises the application of the proposed framework as a solution to redesign the existing EMIS structure of the case study environment.

The case study demonstration considered Service-Oriented Architecture (SOA) as a conceptual design approach for the development of integrated EMIS. This approach models a central

information structure that connects and extends functional modules in a layered architecture. In essence, the different portlets of EMIS in the existing EMIS structure of the case study is re-considered as extended functional modules of the central information system of the integrated EMIS in the case study demonstration.

The case study demonstration of the proposed framework is represented in the Figure 7.3. The conceptual design of the case study demonstration is a representation of the proposed technical framework for the development of integrated EMIS. It demonstrates the representation of the five (5) key components of the proposed technical framework. However, the demonstration is hosted on a cloud platform that gives remote access to users. Meanwhile, unlike in the existing case study EMIS structure, user access to any of the functional module in the case study demonstration is through the central information system that process common information requirements.

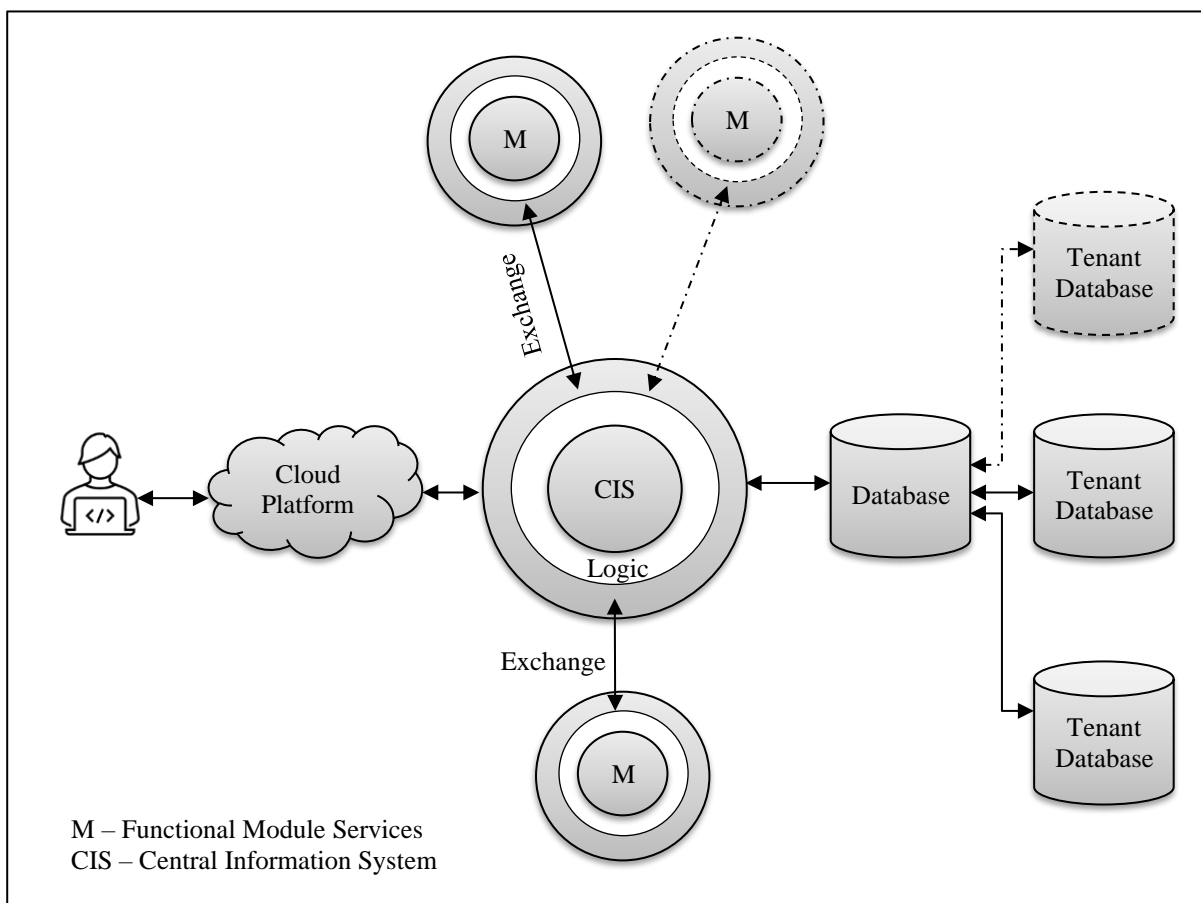

Figure 7.3: Conceptual Design of Case Study Demonstration

The case study demonstration considered the Central Information System (CIS) as a central EMIS module with several other functional module services as extensions that deliver

functional education tasks in a service-oriented design approach. Each service module is wrapped in a layer of programming logic for its demonstration with interfaces for exchanging data. Meanwhile, the database layer provides for a shared storage and retrieval systems for the central and extended service modules to exchange data.

However, the conceptual representation of the case study demonstration aims to show the application of the proposed framework to solve the challenge and limitation with the existing EMIS structure of the case study environment. The technologies and techniques that are used to actualise the demonstration at each component layer of the proposed framework are discussed, within the limit of their meaning and relevance, in the next section of this chapter.

#### **7.4 Case Study Demonstration of the Proposed Framework**

The proposed service-oriented technical framework for the development of integrated EMIS is demonstrated with the application of standard technologies and techniques. The conceptual representation of the demonstration is discussed in the preceding section of this chapter. The emphasis is on a case study demonstration approach that modularise and interconnect functional modules in EMIS with shared database and mechanism for data exchange.

The demonstration of the proposed technical framework considered the information requirements of the case study education institution to develop an integrated EMIS using the Laravel framework as RADE; PHP as programming language; MySQL database for data storage and retrieval; and JSON as standard messaging format for data exchange.

The demonstration of the proposed framework is based on two (2) approaches that demonstrate strategic and technical activities. The strategic approach is based on activities that demonstrate the identified principles for integrated EMIS development as discussed in Section 5.4 of this thesis. Meanwhile, the technical approach is focused on the demonstration of the key technical activities in the proposed framework using the technologies that are available in the development platform to aid the development of integrated EMIS.

The strategic and technical activities in demonstration of the proposed framework are discussed in succeeding subsections, within the context of the components of the proposed technical framework.

### 7.4.1 Education Information Structure

The demonstration of this technical component of the proposed framework followed mainly on the strategic approach of the three (3) related principles in Chapter 5 Section 5.4:

- **Principle 1:** Identify the Information Needs of the Education Institution
- **Principle 2:** Set-up and organise the EMIS Development Team; and
- **Principle 3:** Enhance the Technical Know-how of the EMIS Developers

The correlation of these principles to this component of the proposed framework was discussed in Chapter 6 Section 6.5.1 of this thesis. The demonstration activities that were taken in fulfilling each of these principles are articulated in the Table 7.2.

**Table 7.2: Demonstration Approach of Education Information Structure Component of the Proposed Framework**

Principle 1: Identify the Information Needs of the Education Institution
<p>The Researcher met and discussed with the Director of the University ICT Centre to review the institution objective on the use of EMIS. The key objective is described as:</p> <p style="text-align: center;"><i>“To develop integrated EMIS called Technology-Assisted Education Management System with functional modules that handle specific education tasks: Admissions, Registration, Payments, Assessments and Results with capability for extensions to handle new functional modules as the information needs of the University demand”.</i></p> <p>Meanwhile, the information needs were identified to be the central information structure of the institution that define the interactions among the key descriptive elements of the school system. Other key education tasks within the institution share information with this central information structure.</p>
Principle 2: Set-up and Organise the EMIS Development Team
<p>A 5-man team of EMIS developers, who are technical staff of the University ICT Centre, was commissioned by the Director of the University ICT Centre to work with the ‘Researcher’ on the development of integrated EMIS using the proposed framework as technical design and development guideline.</p>

**Principle 3: Enhance the Technical Know-how of the EMIS Developers**

The Researcher met with the technical team for three (3) hours daily (9am – 12pm) for first one (1) week at the University ICT Centre to further interpret the information needs and objective of the institution to create design focus for the integrated EMIS development.

The researcher spent the first hour of everyday meeting to brief the technical team on component aspects of the proposed technical framework for the development of the integrated EMIS. This is to enhance and share in their knowledge of the new design and development approach. The rest of the meeting, for each day of the week, was focused on discussions around the adaptation of each component of the proposed framework to the University context.

In the context of the case study, the outcome of activities in the demonstration of this component is the representation of the information structure of the institution. This is represented as EIS and is demonstrated, as shown in the Figure 7.4, with provision for the specific information requirements and process flow of the tertiary education institution. The

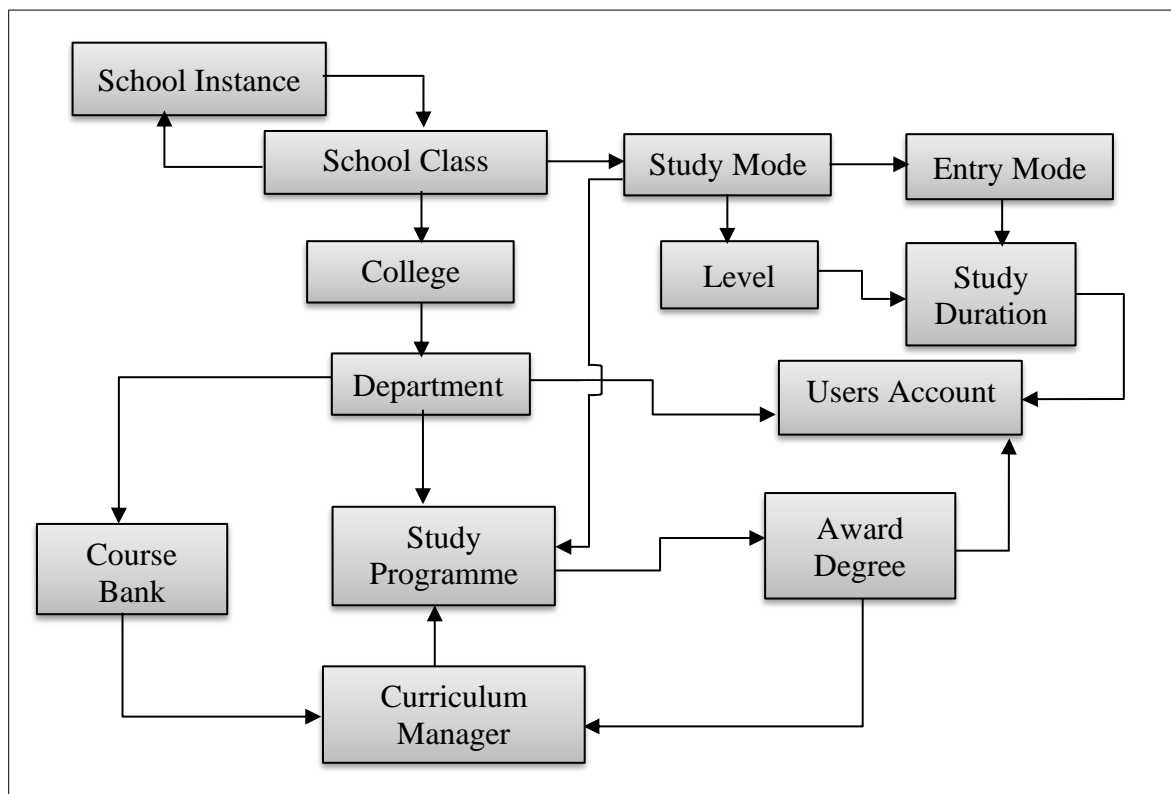

**Figure 7.4: Case Study Implementation of EIS in Tertiary Education Institution**

centre piece of the EIS is the representation of the specific and central information flow of the case study as a CIS package with several services to deliver the functionalities of each information requirement of the tertiary education institution.

Development of the EMIS as an integrated system was considered with the representation of the School Class as a tenant instance that can be extended with cascaded functionalities for the creation and edit of school information structures. Thus, the multi-tenant approach of representing each institution as a tenant on the cloud EMIS platform ensured that several education institutions can be integrated with the case study EMIS development.

However, the custom setting is used to ensure the activation of personalisation of environment on the integrated EMIS for each user and each unit of the institution. The custom setting is a separate functional module in the CIS that define the template that is invoked when a user is authenticated and when a school environment is accessed.

In essence, the CIS is the core of the integrated EMIS to manage school structure and user accounts with security layer for managing authentication and authorisation. The technical demonstration approach of the CIS and the layer of security on the EIS is discussed in Section 7.4.3 that demonstrated the Demonstration Logic component of the proposed framework.

#### **7.4.2 Service-Oriented Design**

The Service-Oriented Design component of the proposed technical framework for the development of integrated EMIS is demonstrated on the strategic approach of these four (4) related principles in Chapter 5 Section 5.4:

- **Principle 4:** Chose the Design Architecture for EMIS Implementation
- **Principle 5:** Adopt a Design Standard
- **Principle 9:** Define Endpoints and Re-Usable Methods for Data Exchange
- **Principle 10:** Make Provision for New Information Needs and Plugins

The correlation of these principles to this component of the proposed framework was discussed in Chapter 6 Section 6.5.2 of this thesis. The strategic activities that were taken in fulfilling each of these principles are articulated in the Table 7.3.



**Table 7.3: Demonstration Approach of Service-Oriented Design Component of the Proposed Framework**

<p><b>Principle 4: Choose the Design Architecture for EMIS Implementation</b></p>
<p>The key objective was reviewed to identify the functional requirements for the design of the integrated EMIS that fit the information needs of the education institution. The functional requirements are identified as key integrated modules that would be developed to deliver on key education tasks, especially at the CIS layer to include users, school, authentication and authorisation managers. The key components and attributes of each of these identified functional modules were also identified to articulate a design approach for the EMIS solution development.</p> <p>The design approach models a layered architecture that separates each module as separate layer of presentation, programming logic and database with defined communication channel for exchanging data.</p>
<p><b>Principle 5: Adopt a Design Standard</b></p>
<p>The Service-Oriented Architecture (SOA) design approach of integrating the functional modules and presenting the components as Web API services that can be re-used and shared was considered by the technical team to model the EMIS development process. The choice of the Web API is based on the general familiarity with the use of the technology by all the team members.</p> <p>The functional modules and the corresponding components were further reviewed to identify the central information requirements that are shared by all modules and components to fit the SOA design approach. These are identified to be basic user profile, education institution structure, roles and permissions. These are considered as the Central Information System (CIS) that will connect all other functional modules.</p>
<p><b>Principle 9: Define Endpoints and Re-Usable Methods for Data Exchange</b></p>
<p>Each component service of the CIS and the functional modules are demonstrated with Web Application Programming Interface (Web API) to expose and consume exchanged data.</p>
<p><b>Principle 10: Make Provision for New Information Needs and Plugins</b></p>

The team reviewed the design architecture and considered a library of Web API to ensure that new information needs that could require development of new module or service can consume API from the Web API library to ease expansion and scalability.

The technical approach to the service-oriented design was considered as technique for the development of integrated EMIS that can scale with the changing and increasing information requirements in the education institution. Thus, this layer of the case study demonstration articulates the concept of developing and connecting functional modules in the CIS of the integrated EMIS.

The requirements for the design and development of integrated EMIS is represented as functional specifications that defined the key education tasks and processes. The functional specifications are then broken down into functional logics. These functional logics represent extensible modules in the integrated EMIS with API that access and exchange data.

In the case study demonstration, the CIS is the core of the integrated EMIS and considered each functional requirements specification as functional modules with definitive logic that runs restful API for connection with the CIS. The functional modules integrate and share resources with the CIS. The pictorial representation of the interaction of components of the CIS based on the service-oriented design is shown in Figure 7.5.

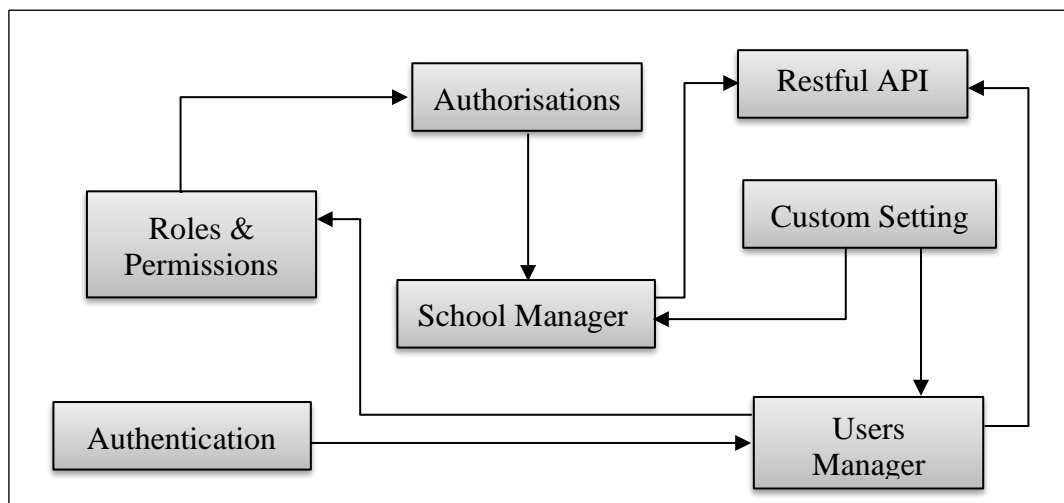

Figure 7.5: Education Information Structure Implementation

At the core of the CIS is the Users and School Managers that handle related information around the different categories of users and structure of the education institution, respectively. Noteworthy is the consideration that the structure of the education institution, as discussed in Section 7.4.1, is defined by its academic and administrative units, and also the culture of processes that is run at different level of the units.

Other functional modules that interconnect with the CIS through restful APIs include Bursary that manages the fees payment; Admission that manages students enrolment; Attendance that manages student attendance in classes; Digital Class that manages the e-learning delivery; e-Resources that share learning resources to students; Messaging that provide communication channel among users; Forum that offer discussion platform among users; Result that manages the computation and processing of students' academic record; Quiz for conducting computer-based testing; Finance for managing schools' basic income and expenditure accounting; Home Work for organising tutorials for students, among other extensible functional modules.

The demonstration of the functional module extensions is represented as a list of menu link that point to the integrated EMIS extension. This is shown in Figure 7.6.

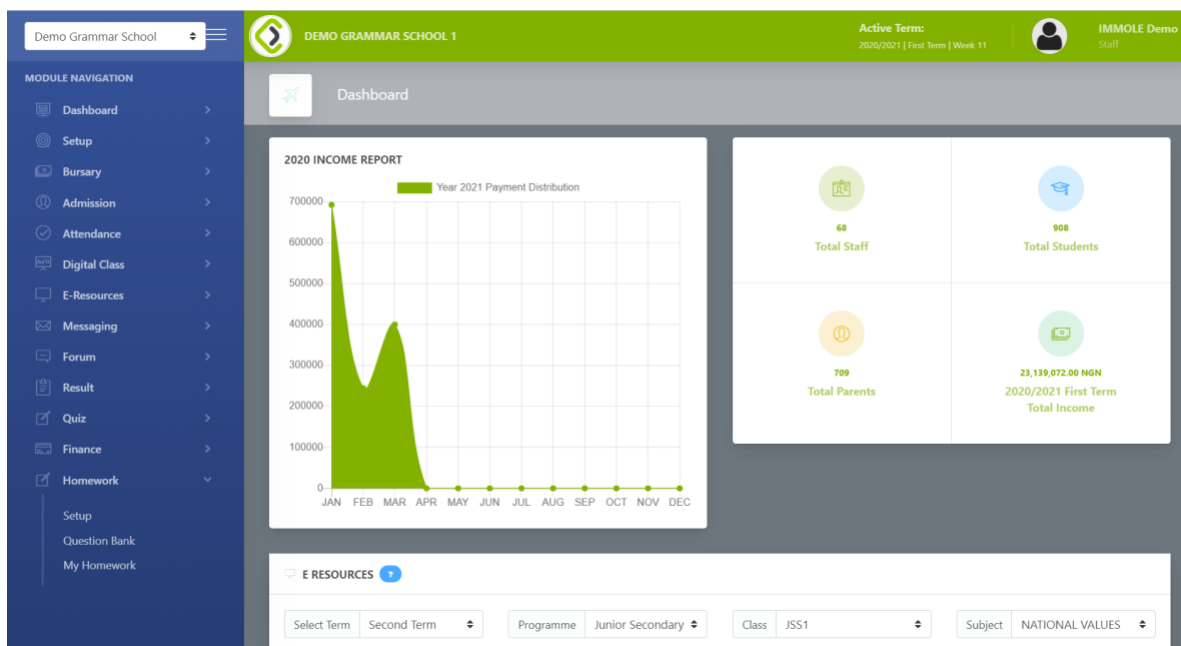

Figure 7.6: Case Study Demonstration of Functional Modules in Integrated EMIS

The programming logic for the demonstration of the key design activities in the Service-Oriented Design component of the proposed framework is discussed in the next Section 7.4.3 that articulate the demonstration logic for the key components of the proposed framework.

### 7.4.3 Demonstration Logic

The demonstration of this technical component of the proposed framework followed the strategic approach of one (1) related principle in Chapter 5 Section 5.4:

- **Principle 8:** Adopt a Standard Programming Logic for EMIS Development

The correlation of this principle to this component of the proposed framework was discussed in Chapter 6 Section 6.5.3 of this thesis. The strategic activities that were taken in fulfilling this principle are articulated in the Table 7.4

**Table 7.4: Demonstration Approach of Demonstration Logic Component of the Proposed Framework**

<b>Principle 8: Adopt a Standard Programming Logic for EMIS Development</b>
<p>The EMIS development process adopted a programming logic and style that delivers on the layered design approach that was adopted in Principle 4. The Model-View-Controller (MVC) programming style using a development framework provided by Laravel was adopted to standardise and ease the development process for the requirements that was taken in the EIS and Service-Oriented Design component layer of the framework. The view layer is used for the presentation of data using the Java Script and Cascaded Style Sheet (CSS); the controller layer is used to program the logic of the EMIS functional module; while the model is used to handle data storage and retrieval processes with the MySQL relational database management system.</p>

Relative to the technical approach to the demonstration of the proposed framework, the demonstration logic layer is considered a programming style and approach to the development of the integrated EMIS. The demonstration logic explores the programming concept and style of implementing tiered design architecture using the MVC development standard of the Laravel framework to demonstrate the development of the CIS and the functional modules. The fundamental approach of the demonstration logic layer on the Laravel platform is represented in Figure 7.7.

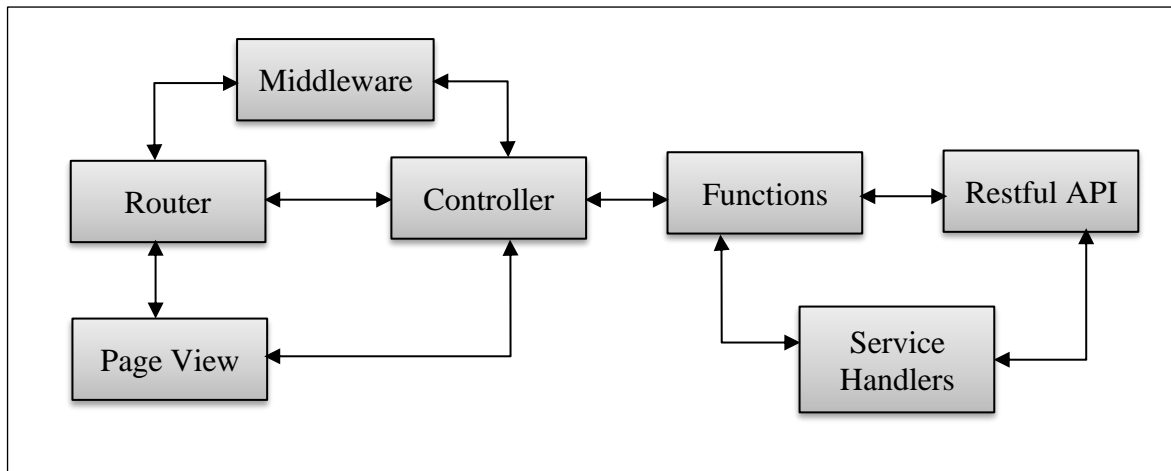

Figure 7.7: Development Logic Demonstration

Interaction with the integrated EMIS is through the execution of the appropriate logic in the controller, which then connect with the router to deliver the appropriate page view. The logic of the controller is based on the development of classes with methods extension as functions that respond to interactions. Restful API extension is used to extend the functionalities of the controller logic with basic operations and views to Create, Read, Update and Delete (CRUD) data. The interactions among functions in the controllers is through the restful APIs. For instance, making a READ request for basic school information to determine user views of some functionalities is through the appropriate call for a RESTful API in the case study demonstration logic as shown in Figure 7.8.

```

1. getSubSchool(id){
2.     if(this.subschid !== undefined || this.subschid !== null){
3.         this.SSLoading = true;
4.         axios
5.             .get(this.$route("app.sub-school", id))
6.             .then((res) => {
7.                 this.subschool = res.data;
8.             })
9.             .catch((err) => {
10.                swal("Error", this.getMessage('failedMessage'),
11.                    "error");
12.            })
13.            .finally(() => {
14.                this.SSLoading = false;
15.            });
16.        },
17.    }
  
```

Figure 7.8: Programming Logic for RESTful API Implementation

A measure of security is provided with the middleware logic layer to filter requests from the interaction with the view, which is being routed to the controllers. This is significant to check conditions with the roles and permissions that are defined in the CIS before access is granted to trigger execution of a functional logic. The middleware is also a layer of control to ensure the seamless flow of execution of functional logics in the demonstration logic layer. For instance, a middleware is provided as a layer of security during user authentication to check the active status of the user account (line 5) and then provide for a redirection to an account activation page (line 6). A case study demonstration of this middleware activity is provided in Figure 7.9.

```
1. class AccountIsActive
2. {
3.     public function handle($request, Closure $next)
4.     {
5.         if ($request->user()->status == 'inactive') {
6.             return redirect()->route('account.not-active');
7.         }
8.         return $next($request);
9.     }
10. }
11.
```

Figure 7.9: Programming Logic for Middleware Implementation

Additionally, a provision is made for the extension of the controller functions with a layer of the service handlers that are majorly listener functions. The key function of the listener function is to trigger an event to execute another function or call to consume another restful API base on action that is executed in another function. The significance of this is major in such instance, as shown in

`class StaffCreated`

```
1. {
2.     use Dispatchable, InteractsWithSockets, SerializesModels;
3.
4.     public $staff;
5.
6.     public function __construct(Staff $staff)
7.     {
8.         $this->staff = $staff;
9.     }
10.
11.     public function broadcastOn()
12.     {
13.         return new PrivateChannel('channel-name');
14.     }
15. }
```

```

16.
17. class CreateStaffListener
18. {
19.
20.     public function handle(StaffCreated $event)
21.     {
22.         $user_id = $event->staff->user_id->toString();
23.
24.         $roles = Role::getPrimaryRole($event->user_type->toString());
25.         $user = User::where('id', $user_id)->first();
26.         $user->syncRoles($roles);
27.     }
28. }

```

Figure 7.10, when a new user account is created (line 7 – line 10), a listener is triggered (line 21) to assign default user role and permission. This is to ensure that the user authentication and authorisation has a basic profile redirection when an attempt is made to login. This demonstration of the listeners and event trigger in the case study demonstration ensures the seamless integration of the services and modules in the integrated EMIS.

```

29. class StaffCreated
30. {
31.     use Dispatchable, InteractsWithSockets, SerializesModels;
32.
33.     public $staff;
34.
35.     public function __construct(Staff $staff)
36.     {
37.         $this->staff = $staff;
38.     }
39.
40.     public function broadcastOn()
41.     {
42.         return new PrivateChannel('channel-name');
43.     }
44. }
45.
46. class CreateStaffListener
47. {
48.
49.     public function handle(StaffCreated $event)
50.     {
51.         $user_id = $event->staff->user_id->toString();
52.
53.         $roles = Role::getPrimaryRole($event->user_type->toString());
54.         $user = User::where('id', $user_id)->first();
55.         $user->syncRoles($roles);
56.     }
57. }

```

Figure 7.10: Programming Logic for Event and Listener Demonstration

The demonstration logic for the case study integrated EMIS development is then extended to demonstrate the technical activities in the Education Information Structure and Service-Oriented Design components of the proposed framework. The demonstrations are illustrated thus:

#### A. Demonstration Logic for Education Information Structure

The CIS runs on a layer of security that uses the authentication library in the Laravel framework to grant access to the different categories of users in the education institution. Another layer of security and control is defined by the functional module that manage roles and permissions. In this instance, services that run within the CIS are wrapped in permission and a group of permissions are defined for the different user roles. Meanwhile, the structure of the education institution is implemented in the school manager module. Access to the school manager is granted through a layer of security that is defined in the authorisation function.

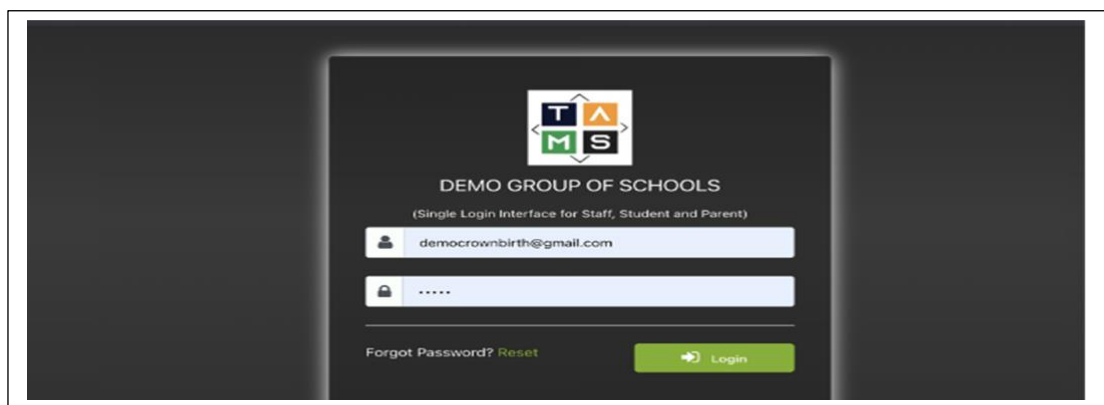

Figure 7.11: Case Study Demonstration of User Authentication

The Access control for the User Account module is implemented on the basic Laravel library of authentication and authorisation that provide interface to process the user login credentials. The demonstration of the unified login interface for all user categories in the case study demonstration is shown in Figure 7.11.

The user defined permissions are checked after login validation to determine access to other functionalities for the user type category. User type in this case study demonstration is categorised as Student, Staff, Parent and Administrator with defined roles and permissions to access specific integrated EMIS functionalities.

The authentication and authorisation, with the login function, is implemented in the case study with the programming logic, as shown in Figure 7.12, that takes the login credentials from the



unified user login interface. This is then checked with the stored users' record (line 10) to determine validity. A redirection of the user to the appropriate page interface with appropriate module permissions based on assigned roles is then initiated (line 13 – line 16).

```
1. class LoginController extends Controller {
2.     public function __construct()
3.     {
4.         $this->middleware('guest:agent')->except('logout');
5.     }
6.
7.     public function login(Request $request)
8.     {
9.         // Validate User Form request
10.        $this->validator($request);
11.        //attempt login.
12.        if (Auth::guard('web')->attempt($request->only('email', 'password'), $request->filled('remember')))
13.        {
14.            $this->loadPermission();
15.            $user_type = Auth::user()->type_id;
16.
17.            return redirect()
18.                ->intended(route($this->get_user_dashboard_route($user_type)))
19.                ->with('success', 'You are Logged in');
20.        }
21.        return $this->loginFailed();
22.    }
```

Figure 7.12: Programming Logic for Authentication and Authorisation into the Integrated EMIS

Meanwhile, the roles and permission functionality provide flexibility to define authorisation for different category of users. There are system-defined roles with default set of permissions for the different user categories and for specific job roles in the education system. These roles include Administrator, Teacher, Student, Parent, Class Teacher, Subject Teacher, Principal and Bursar, among others. Privileged users can define new roles and assign set of permissions. Users that are added to these roles can inherit the assigned permissions. This method of authorisation is demonstrated in the case study with the functional module on Roles and Permission in the CIS, as shown in Figure 7.14

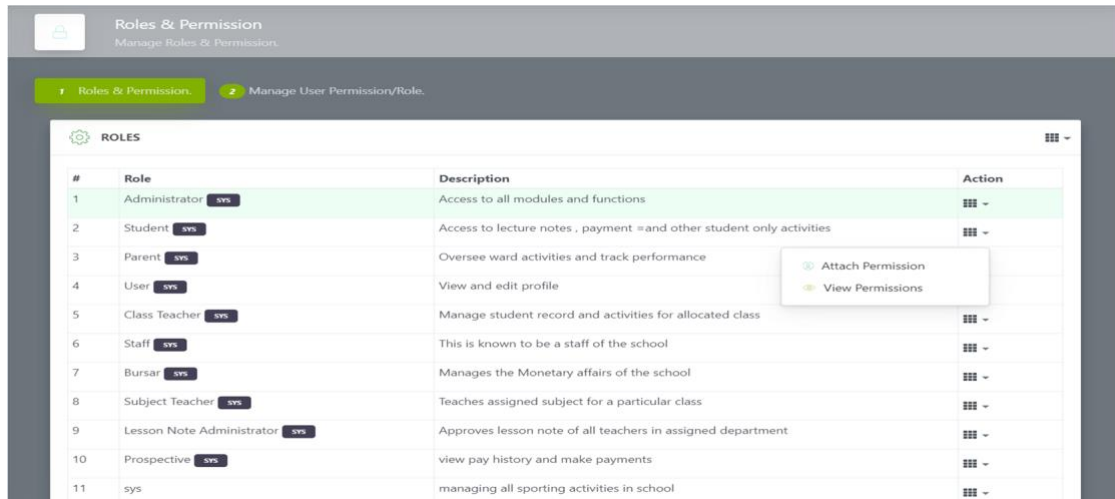

Figure 7.14: Case Study Demonstration of User Authorisation

However, the programming logic for the creation and assignment of roles (line 14 – line 16) and permission (line 10 – line 12) to authorised users (line 5 – line 7), is however, shown in Figure 7.13.

```

1. Class UserRolesPermission{
2.     public $user;
3.
4.
5.     public function __constructor($user) {
6.         $this->user = $user;
7.     }
8.
9.
10.    public function attachPermission($perm) {
11.        $user->givePermissionTo($perm);
12.    }
13.
14.    public function attachRole($role) {
15.        $user->giveRole($role);
16.    }
17. }
18.

```

Figure 7.13: Programming Logic for Authorisation with Assignment of Roles and Permissions

## B. Demonstration Logic for Service-Oriented Design

Meanwhile, the case study demonstration of this scalable service-oriented design that allow for extensible functional modules is based on a programming logic that call services through RESTful APIs. The logic approach is that each module is registered in the database and registered into the CIS of the integrated EMIS. Thus, new functional module can be registered

in the database and made accessible to authenticated users. With roles and permissions, the bundle of modules is delivered to each authenticated user.

The programming logic, as shown in Figure 7.15, consider an authenticated user (line 4) and check for the roles and permission to fetch the list of CIS and functional modules services that are accessible to the authenticated user (line 6). This is passed as an array of module links to the front-end view for display to the user (line 15 – line 25)

```
1. public function userMenu(Request $request)
2.     {
3.
4.         $user = Auth::user();
5.
6.         $menus = $this->getMenus($user, $user->getPermission())
7.
8.         $menuArray = [
9.             [
10.                'header' => true,
11.                'title' => "Module Navigation"
12.            ]
13.        ];
14.
15.        foreach ($menus as $key => $menu) {
16.            $array = [
17.                'title' => $menu->pac_name,
18.                'icon' => $menu->pac_icon,
19.                'child' => $menu->getChild();
20.            ];
21.            array_push($menuArray, $array);
22.
23.        }
24.
25.        return response()->json(['menu' => $menuArray]);
26.    }
27. }
28.
```

Figure 7.15: Programming Logic for Integrating RESTful Services of Functional Modules of Integrated EMIS

These blocks of codes use JSON array (line 16 – line 20) to manage data communication and exchange among the three (3) layers of the programming logic. The array of data that defines the users' permissions is stored in JSON format and passed to the other functional programming logic that loops through the permissible functional modules of the integrated EMIS.

To ensure that the CIS is able to connect with other functional modules in the integrated EMIS, a registry of restful API is defined. This registry contains a declaration of a number of defined web API for exchanging information about the users and information structure of the education

institution. Typical restful API in the registry expose endpoints for collecting and exchanging data on school and user managers, as shown in Figure 7.16.

```

1. Route::group(['prefix' => '/academics'], function () {
2.
3.     Route::get('/school', 'App\AcademicController@school_subschool')-
>name('academics.school')->middleware(['setup.stage']);
4.     Route::get('/college', 'App\AcademicController@college_programme')-
>name('academics.college')->middleware(['setup.stage']);
5.     Route::get('/level', 'App\AcademicController@level_arm')->name('academics.level')-
>middleware(['setup.stage']);
6.     Route::get('/session-term-week', 'App\AcademicController@session_term_week')-
>name('academics.session')->middleware(['setup.stage']);
7.     Route::get('/level-course-manager', 'App\AcademicController@level_course_manager')-
>name('academics.level-course-manager')->middleware(['setup.stage']);
8.     Route::get('/scheme-of-work', 'App\AcademicController@scheme_of_work')-
>name('academics.scheme-of-work')->middleware(['setup.stage']);
9.     Route::group(['prefix' => '/subschool'], function () {
10.

```

Figure 7.16: Programming Logic for RESTful API Registry

#### 7.4.4 Exchange Mechanism

The demonstration of this technical component of the proposed framework followed the approach of the three (3) related principles in Chapter 5 Section 5.4:

- **Principle 6:** Choose the Standard Data Format for Information Exchange
- **Principle 7:** Ensure EMIS Gain Access to Shared Database
- **Principle 11:** Collect and Store Data from Multiple Data Sources

The correlation of these principles to this component of the proposed framework was discussed in Chapter 6 Section 6.5.4 of this thesis. The strategic activities that were taken in fulfilling each of these principles are articulated in the Table 7.5.

Table 7.5: Demonstration Approach of Exchange Mechanism Component of the Proposed Framework

Principle 6: Choose the Standard Data Format for Information Exchange
The need for data exchange among the functional modules was reviewed with the options of using Extensible Markup Language (XML) or Java Script Object Notation (JSON) as standard data exchange mechanism. The technical team, based on general usage familiarity,

considered the use of light weight data exchange format, JSON, as standard format for exchanging data between Web API service components of each functional modules.

**Principle 7: Ensure EMIS Gain Access to Shared Database**

The database layer of the tiered architecture of the integrated EMIS was reviewed by the team members. A MySQL relational database management system is considered for storing data based on its open source and relative performance capacity to handle large data sets. All modules are designed to share separate tenant database with main database that keep inter-related tables to manage separate and shared data

**Principle 11: Collect and Store Data from Multiple Data Sources**

Normalisation of the database is enforced to ensure that every module stored and retrieved data from the shared database system. An API mechanism is considered for storing and retrieving data from tenant database of each EMIS functional module extensions.

The technical approach activities for the exchange mechanism are demonstrated as a layer of data communication and transportation in the development of integrated EMIS. The communication is implemented as data exchange among functional modules and between functional modules and the CIS.

Data communication and transportation is majorly through serialisation and deserialization of JSON messages. The significance of the JSON message format for data communication is emphasised in data manipulation with the storage system. Non-relational data, in some instances, is passed and stored in the storage system in JSON message format as text to simplify data manipulation with relational database system. Methods of the functional module is used to de-serialise the JSON message for use in the programming logic. Also, restful APIs and methods of functional modules of the integrated EMIS expose and consume data through endpoints specification that accept parameters and arguments. The exposure and consumption of endpoints of APIs and methods of functional modules further simplified data exchange in the integrated EMIS.

For instance, the case study demonstration for the JSON data exchange is demonstrated with the REST API that collect user statistics from the shared database. The data is transformed in an array and then serialised in JSON format for exchange. The mechanism of data exchange is demonstrated with a call to `getTotalStudentJson` method (line 10), which is an endpoint API that returns an array of student records in JSON. The returned data is deserialized into another array of data (line 18). This is then returned with other data set as another array of data in JSON for exchange (line 22), as shown in Figure 7.17.

```

1. // function to get user statistics
2. public function get_stat($subschid) {
3.     $ses_term = getActiveTerm($subschid)->id;
4.
5.     $user = new User;
6.     $total_users = User::all()->count();
7.
8.     $total_staffs = Staff::all()->count();
9.     $total_parents = Guardian::all()->count();
10.    $total_students = getTotalStudetInJson();
11.
12.    $total_male_parents = User::has('guardian')->where('sex', '=', 'male')->count();
13.    $total_female_parents = User::has('guardian')->where('sex', '=', 'female')->count();
14.
15.    $data = [
16.        'users' => $total_users,
17.        'staffs' => $total_staffs,
18.        'students' => json_decode($total_students, true)['to_stud'],
19.        'parents' => $total_parents,
20.    ];
21.
22.    return response()->json(['data' => $data], 200);
23. }
24.

```

Figure 7.17: Programming Logic for JSON Data Exchange Demonstration

### 7.4.5 Database System

The demonstration of this technical component of the proposed framework followed the approach of the one (1) related principle in Chapter 5 Section 5.4:

- **Principle 12:** Present Data in Format that Support Decision-Making

The correlation of these principles to this component of the proposed framework was discussed in Chapter 6 Section 6.5.1 of this thesis. The activities that are taken in fulfilling each of these principles are articulated in the Table 7.6.

**Table 7.6: Demonstration Approach of Database Systems Component of the Proposed Framework**

<p><b>Principle 12: Present Data in Format that Support Decision-Making</b></p>
<p>A report service, showing appropriate data analytic, is embedded in each module to ensure the presentation of information in statistical and graphical representational format that meet end-user requirements.</p>

The database system is implemented as a system for data storage and retrieval in the development of integrated EMIS. The database system is demonstrated with an open-source Relational Database Management System (RDBMS) using MySQL.

The MySQL uses a combination of tables to manage related records in rows and columns. Several tables are inter-connected on related columns with Referential Integrity (RI) to ease the process of joining tables to extract data for manipulation and exchange.

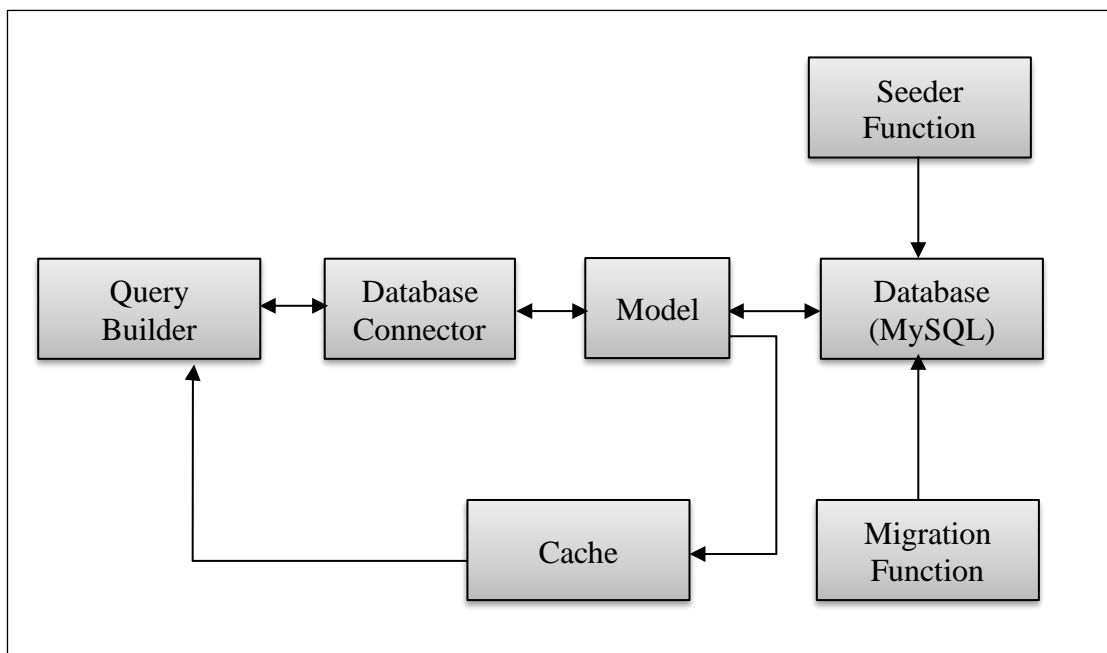

**Figure 7.18: Database System Demonstration**

The significance of the RI in implementing the RDBMS is critical in ensuring data consistency and reliability, which eases the maintainability of the database system. The case study demonstration of the database system on the Laravel platform is represented in the Figure 7.18.

The Laravel framework provided for methods of feeding data into the RDBMS to ensure consistent data storage system. This is ensured with the migration and seed functions that respectively prepare tables and insert preliminary data into the database. In the case study demonstration, the seed and migration functions are used to manage scalability and continuous development that require creation of new tables and insertion of new data in the database.

The case study demonstration of the migration function for creation of user table in the shared database is provided in Figure 7.19. Additionally, there is a corresponding seed function for the insertion of data into the migrated user table as demonstrated in the Figure 7.20.

```

1. class CreateUsersTable extends Migration
2. {
3.     public function up()
4.     {
5.         Schema::create('users', function (Blueprint $table) {
6.             $table->uuid('id')->primary();
7.             $table->string('user_id')->unique()->nullable();
8.             $table->string('fname');
9.             $table->string('lname');
10.            $table->string('mname')->nullable();
11.            $table->string('email')->unique()->nullable();
12.            $table->string('phone')->unique()->nullable();
13.            $table->enum('sex', ['male', 'female'])->nullable();
14.            $table->date('dob')->nullable();
15.            $table->string('image')->nullable();
16.            $table->text('address')->nullable();
17.            $table->foreignId('lga_id')->nullable()->constrained('state_lgas');
18.            $table->timestamp('email_verified_at')->nullable();
19.            $table->string('password');
20.            $table->enum('religion', ['Islam', 'Christianity', 'Traditional', 'others'])->nullable();
21.            $table->rememberToken();
22.            $table->enum('is_admin', ['1', '2'])->nullable();
23.            $table->timestamps();
24.        });
25.    }
26.
27.    public function down()
28.    {
29.        Schema::dropIfExists('users');
30.    }
31. }

```

Figure 7.19: Programming Logic for Database Migration Function Demonstration

```

1. class AdminSeeder extends Seeder
2. {
3.     public function run()
4.     {
5.         $admin = array(

```



```

6.
7.     array(
8.         'email' => "crownbirth@gmail.com",
9.         'lname' => 'Crownbirth',
10.        'fname' => 'Limited',
11.        'address' => 'Igbomokun Ijebu-ife',
12.        'image' =>
13.        "https://res.cloudinary.com/crownbirthltd/image/upload/v1597424758/psitywq3w0z4wzpojmp8.png
14.        ",
15.        'lga_id' => 571,
16.        'password' => bcrypt('12345'),
17.        'is_admin' => 1
18.    )
19. );
20. if(Auth::user()->email != "crownbirth@gmail.com"){
21.     $admin[] = [
22.         'email' => Auth::user()->email,
23.         'lname' => Auth::user()->lname,
24.         'fname' => Auth::user()->org_name,
25.         'address' => Auth::user()->address,
26.         'image' =>
27.         "https://res.cloudinary.com/crownbirthltd/image/upload/v1597424758/psitywq3w0z4wzpojmp8.png
28.         ",
29.         'lga_id' => Auth::user()->lga_id,
30.         'password' => bcrypt('12345'),
31.         'is_admin' => 1
32.     ];
33. }
34. foreach ($admin as $value) {
35.     $user = User::updateOrCreate($value);
36.     // $staff = new Staff();
37.     // $staff->user_id = $user->id;
38.     // $staff->save();
39. }
40. }

```

Figure 7.20: Programming Logic for Seed Function Demonstration

Meanwhile, access to the database is through a connection credentials that is saved and accessed from the connection file within the model layer of the Laravel development platform. Data manipulation is through the Structured Query Language (SQL) to store and retrieve data from the RDBMS.

Frequently accessed data is stored in the cache mechanism that is specified in the cache configuration file of the Laravel platform. This reduces workload on the RDBMS and improve the performance of the database system to respond to requests for data retrieval.

## 7.5 Closing Remark

The emphasis in this chapter is a case study demonstration of the proposed technical framework for the development of integrated EMIS that can seamlessly exchange data. The procedure for

the case study demonstration aligned with the argument by (Chotisarn & Sanpote, 2017) for stages in software implementation process. However, the approach for the demonstration of each component of the proposed framework followed the related strategic and technical activities in the twelve (12) design principles that were identified and discussed in Chapter 5 Section 5.4 of this thesis.

The existing architecture of portlets of EMIS that is in use in the case study environment is conceptualised and discussed. However, to further articulate the relevance of the proposed framework to the development of integrated EMIS that redefine the existing EMIS architecture, a conceptual design of integrated EMIS on a cloud platform is used to contextualise the case study demonstration. This is based on the five (5) key components of the proposed technical framework for the development of integrated EMIS.

The case study demonstration considered an open source Laravel framework as a development platform for the demonstration of the development of integrated EMIS based on the proposed framework. The EIS component is implemented as CIS to manage users and generic school information with a layer of authorisation and authentication security that is strengthened by the roles and permissions module.

The service-oriented design is demonstrated as the basis to recontextualise the portlets of EMIS in the existing architecture as extension of functional modules that integrates with the CIS. The Demonstration Logic is demonstrated as standard programming style with PHP code base that is based on the MVC approach that supports tiered architecture on the Laravel framework.

Data exchange is by RESTful API with JSON data format to expose and consume data across modules and the CIS. Meanwhile, data storage and retrieval is implemented on the MySQL as an open source RDBMS with migration and seed functions for data storage and SQL for data manipulation and retrieval.

In essence, the proposed framework can be demonstrated with the conceptualisation of EMIS as an integrated system with a service-oriented design architecture that considered the common information requirements of the education system as a Central Information System with other education tasks as functional module extensions that integrate with the CIS. The demonstration logic is on a standard programming style that uses REST services to manipulate and exchange data, and to connect with shared database for storage and retrieval of requests processing.

Noteworthy, this chapter provide basis to partly answer the fifth research question on the demonstration of the proposed service-oriented technical framework. The evaluation of the proposed technical framework is discussed in the succeeding Chapter 8 of this thesis.

## CHAPTER 8 : EVALUATION OF PROPOSED TECHNICAL FRAMEWORK

This chapter raises arguments on the evaluation of the proposed service-oriented technical framework for the development of integrated EMIS. The evaluation is based on expert reviews and comparative analysis using the framework requirements that are identified from the research findings as baseline. The analysis of the evaluation is used as a basis to partly answer the fifth research question:

- v. **How can the design of a service-oriented technical framework for the development of integrated EMIS be demonstrated and evaluated?**

Meanwhile, the arguments for discussions on the evaluation of the proposed framework is organized into sections and subthemes as represented in the Figure 8.1

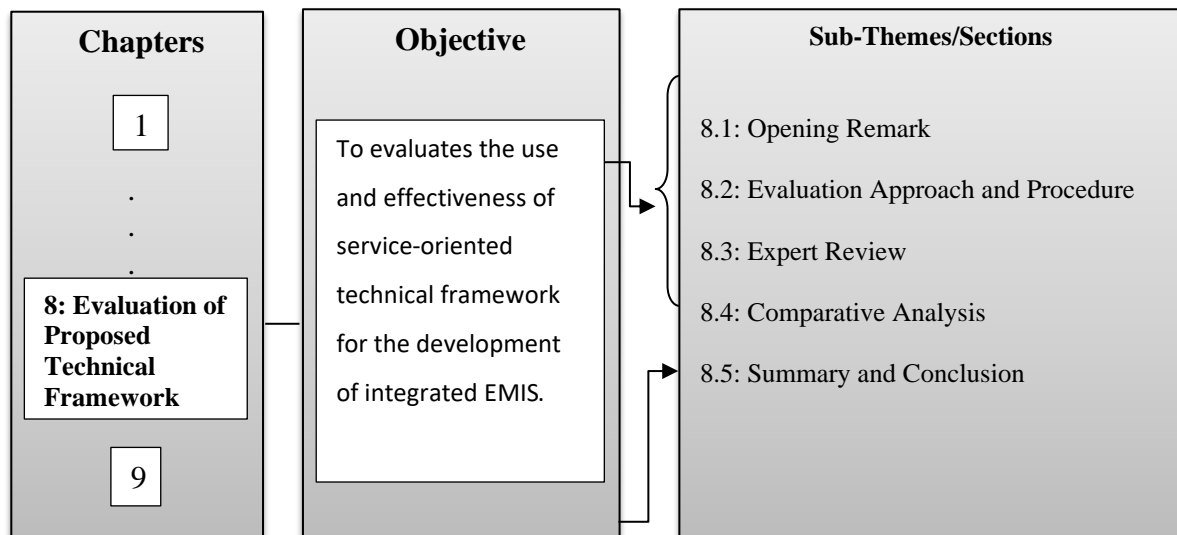

Figure 8.1: Objective Overview of Chapter Eight

The Opening Remark subtheme (Section 8.1) contextualizes the significance of expert review and comparative analysis to the evaluation of the proposed technical framework for the development of integrated EMIS. The Evaluation Approach and Procedure subtheme (Section 8.2) captures the process and procedures for the expert review and comparative analysis.

The Expert Reviews subtheme (Section 8.3) appraised the analysis of the responses from expert reviews to raise arguments on the appropriateness of the proposed framework. The Comparative Analysis subtheme (Section 8.4) identified, compared, and assessed other existing frameworks against the proposed framework.

The Closing Remark subtheme (Section 8.5) summarizes the arguments in this chapter to articulate answer to the research question that is addressed in this chapter.

## **8.1 Opening Remark**

To strengthen the reliability and validity of the proposed framework, the evaluation process plays a significant role (Ridder, 2017). Designing evaluation, therefore, requires a consideration of reviewer, space, and time to strengthen the formative approach of evaluation that assesses the end-product of a research study (Woolf, 2009).

In the context of the Design Science Research Methodology, Ahmed & Sundaram (2011) argued for an artefact-centric evaluation process as a clear measure of fit-for-purpose of technological artefact base on its functionality requirements that can be assessed using the qualitative or quantitative methodological approaches. The author argued further that the quantitative approach involves an assessment of the artefact base on comparison with others. Meanwhile, the qualitative approach considers opinions of evaluators like practice experts on the functionality of artefacts.

Thus, in evaluating the proposed framework, based on the case study demonstration, expert review and comparative analysis methods were adopted to validate the research output and benchmark it against existing frameworks to check reliability.

This chapter, therefore, articulate a procedure and approach for conducting the case study evaluation of the proposed framework. Criteria for the evaluation process were raised and discussed within the context of the identified requirements for the design of framework for integrated EMIS development.

These requirements were identified and discussed in Chapter 5 Section 5.5 of this thesis. Further discussions and arguments are, however, provided to justify the significance and procedure for the expert review using the close-ended questionnaire as tool. Basis for comparative analysis is also articulated and discussed.

The evaluation of the proposed service-oriented technical framework for the development of integrated EMIS within the context of the case study demonstration are further discussed in the succeeding subsections of this chapter.

## 8.2 Evaluation Approach and Procedure

The approach in this evaluation is to gather feedback and compare the proposed framework with existing ones as a basis to draw general review on evaluation. As discussed in Chapter 1 Section 1.7.4 of this thesis, the expert review is targeted at practice expert, as against research expert, to ensure that the feedbacks are centred around the technical review on the effectiveness of the proposed framework. Meanwhile, the identified requirement also formed the review criteria to compare and benchmark the proposed framework with two (2) other existing frameworks for EMIS integration.

In essence, therefore, the following procedure were followed for the evaluation process to ensure consistency and articulation of the evaluation review process.

- **Step 1:** Identification and selection of ten (10) practice experts with industry experience in education and technology to ensure relevant background knowledge.
- **Step 2:** Sharing of the close-ended expert review questionnaire together with the proposed framework and the case study demonstration documents with the selected experts to help their understanding and the quality of the feedback
- **Step 3:** Analysis of questionnaire feedback with statistical tool and discussion of the results.
- **Step 4:** Identification of key technical values under each component of the proposed framework to set benchmark for comparison with two (2) other existing EMIS integration frameworks.
- **Step 5:** Review of the proposed framework against identified requirements for design and development of integrated EMIS.

The discussion around this evaluation procedure is the basis for argument in the succeeding subsections of this chapter.

## 8.3 Expert Review

The focus in this section is to validate the proposed framework within the context of the identified six (6) requirements for the development of integrated EMIS. The essence of the validation, in the argument of Chemuturi (2013), is to confirm, authenticate or corroborate a claim about a system to justify that its demonstration meets the specified requirement. Chemuturi (2013) further established the argument on the use of brainstorming, storyboarding, prototyping, end-user review and expert review as tools for the validation exercise.

In the context of this study, the expert review is considered an evaluation tool that offer objective assessment of experts (Keh & Sun, 2018) to benchmark and validate the effectiveness of the proposed framework. The procedure for the expert review considered the use of close-ended questionnaire to collect and assess the opinions of ten (10) selected experts with background experience in the subject area of technology for education. The selection was random but purposive to ensure the standard and quality of the assessment feedback.

The close-ended questionnaire, as shown in the APPENDIX 5, raised questions on the key functionalities of the components of the proposed framework. These questions are categorised under each element of the identified requirements from research findings as discussed in Chapter 5 Section 5.5, which are the benchmark parameters for the evaluation: Adaptability, Maintainability, Standardisation, Scalability, Connectivity and Accessibility. However, the Justification section of the questionnaire is to add a layer of test of relevance and necessity of the proposed framework to the development of integrated EMIS.

### **8.3.1 Approach and Procedure**

To grade the responses of the experts' opinion to each item in the questionnaire, an ordinal 5-point Likert Scale is used, which "are typically interpreted by strongly disagree, disagree, neutral (undecided), agree and strongly agree" (Tutz, 2020). The feedback from the expert review is represented with the frequency of occurrence of responses to each question as shown in the APPENDIX 5. In analysing the questionnaire responses, the arguments of Sullivan & Artino (2013) is sacrosanct that median, as a measure of central tendency, is appropriate for statistical analysis of Likert scale responses.

For emphasis, the Statistical Package for Social Science (SPSS) version 20.0, which a statistical analysis software, was considered for the data analysis of feedback from the questionnaire. However, the following procedure was adopted for the analysis of the questionnaire responses using the SPSS:

- i. The scale of responses for each question, that is, dependent variable: Strongly Disagree (SD), Disagree (D), Undecided (U), Agree (A) and Strongly Agree (SA) were coded with ordinal value of 1, 2, 3, 4, 5 respectively.
- ii. The questions are grouped into categories that represent the benchmark parameters, which are the independent variables. The parameters are the identified six (6)

requirements for the design and development of integrated EMIS, together with additional parameter for justification of the relevance of the proposed framework.

- iii. The variable data was fed into the SPSS software to generate the percentile for response frequencies for each of the independent variable.
- iv. The percentile data was then used to compute the median for each dependent variable and the cumulative median for the independent variable.
- v. The result was then generated and interpreted for discussion based on the decision range of 0 – 1 meaning Strongly Disagree; 1.1 – 2 meaning Disagree; 2.1 – 3 meaning Undecided; 3.1 – 4 meaning Agree and 4.1 – 5 meaning Strongly Agree.

### 8.3.2 Analysis and Interpretations

The discussion around the interpretation of the expert review is based on the result of analysis of Likert scaled questionnaire. APPENDIX 5 shows the expert review questionnaire with the frequencies of responses for each Likert scale items that are categorized into six (6) independent variables: Justification, Adaptability, Maintainability, Standardization, Scalability, Connectivity, and Accessibility. These independent variables are the basis of evaluation of the proposed framework with the expert review.

The SPSS software was used for analyzing the questionnaire to test the reliability of responses for each independent variable using the Cronbach’s Alpha and to also generate the median for each Likert item as a basis for determining the decision median for each independent variable. The value of the Cronbach’s Alpha ranges between 0 and 1 to show the degree of reliability.

The result of the analysis and interpretation of each independent variable for evaluation is provided below. For this study, a Cronbach’s Alpha value above 0.5 is considered a good validity of the scale and reliability of the internal consistency of the data set.

#### A. Justification:

		N	%
Cases	Valid	10	100.0
	Excluded <sup>a</sup>	0	.0
	Total	10	100.0

Cronbach's Alpha	N of Items
.633	3

a. Listwise deletion based on all variables in the procedure.



**Table 8.1: Analysis of Expert Review on Justification of the Proposed Framework**

S/No.	Questions	Median	Decision
Q1	Do you agree that integrated EMIS is required to optimise processes in education institutions	5.00	Strongly Agree
Q2	Is technical framework required for the development of integrated EMIS that can optimised education processes?	4.00	Agree
Q3	Is the proposed technical framework adequate for the development of integrated EMIS?	5.00	Strongly Agree
<b>Decision Median</b>		<b>5.00</b>	<b>Strongly Agree</b>

The general opinions of the experts align with the purpose and motivation for this research study, which emphasised the need for a standard framework for the development of integrated EMIS. This is affirmed in Table 8.1 that shows the decision median of 5.0, which indicates that the experts strongly agree to justify the need and adequacy of the proposed framework to the development of integrated EMIS that optimises processes in the education system.

**B. Adaptability**

**Case Processing Summary**

		N	%
Cases	Valid	10	100.0
	Excluded <sup>a</sup>	0	.0
<b>Total</b>		<b>10</b>	<b>100.0</b>

a. Listwise deletion based on all variables in the procedure.

**Reliability Statistics**

Cronbach's Alpha	N of Items
.562	2

**Table 8.2: Analysis of Expert Review on Adaptability of the Proposed Framework**

S/No.	Questions	Median	Decision
Q4	Do you agree that a framework for the development of integrated EMIS should be adaptable to the specific information requirements of the education system?	4.00	Agree
Q5	Does the modular functionality of the Central Information System in the Education Information System component of the technical framework make the integrated EMIS adaptable to the education system?	4.50	Agree
<b>Decision Median</b>		<b>4.25</b>	<b>Agree</b>

The proposed framework was evaluated based on the requirement for adaptability of integrated EMIS to the specific information requirement of the different education system. Table 8.2 shows a decision median of 4.25, which indicates that the general opinions of the experts agree to the need and provision in the proposed framework to address the adaptability of the integrated EMIS development to fit into the evolving and changing information requirement of the education system using an approach of modular functionality of the Central Information System.

### C. Maintainability

		N	%
Cases	Valid	10	100.0
	Excluded <sup>a</sup>	0	.0
	Total	10	100.0

Cronbach's Alpha	N of Items
.627	2

a. Listwise deletion based on all variables in the procedure.

Table 8.3: Analysis of Expert Review on Maintainability of the Proposed Framework

S/No.	Questions	Median	Decision
Q8	Is the ease of maintenance a requirement in the design of technical framework for the development of the integrated EMIS?	4.50	Strongly Agree
Q9	Does the use of simple and familiar technologies, like REST API with JSON, in the framework demonstration ease the maintenance of the integrated EMIS development?	4.50	Agree
	<b>Decision Median</b>	<b>4.50</b>	<b>Strongly Agree</b>

Table 8.3 shows the analysis of the expert review feedback on the evaluation of the proposed framework base on the maintainability requirement. The result indicates a decision median of 4.50. This shows that the general opinion of the experts aligns with the need and provision for consideration of maintainable approach of the proposed framework to the development of integrated EMIS using simple and familiar technology like the REST API with JSON for data exchange.

#### D. Standardisation

**Case Processing Summary**

		N	%
Cases	Valid	10	100.0
	Excluded <sup>a</sup>	0	.0
	Total	10	100.0

**Reliability Statistics**

Cronbach's Alpha	N of Items
.837	3

a. Listwise deletion based on all variables in the procedure.

**Table 8.4: Analysis of Expert Review on Standardisation of the Proposed Framework**

S/No.	Questions	Median	Decision
<b>Q10</b>	Do you agree that the education system requires standard framework to guide the development of integrated EMIS that can seamlessly exchange data?	4.00	Agree
<b>Q11</b>	Is the use SOA approach to the design concept of the proposed framework standardise the development of integrated EMIS?	4.50	Strongly Agree
<b>Q12</b>	Does the use of tiered architecture that separates the integrated EMIS development into layers of programming logics standardise the demonstration of the proposed framework?	4.50	Agree
<b>Decision Median</b>		<b>4.50</b>	<b>Strongly Agree</b>

The analysis of expert opinion for the evaluation of the proposed framework base on the standardisation requirement is indicated in the Table 8.4. The decision median of 4.50 indicates the concurrence of the expert review to the need and provision for standardisation in the proposed framework for the development of integrated EMIS using a SOA as design approach and tiered architecture that separates the EMIS structure into layers of programming logic.

#### E. Scalability

**Case Processing Summary**

		N	%
Cases	Valid	10	100.0
	Excluded <sup>a</sup>	0	.0
	Total	10	100.0

**Reliability Statistics**

Cronbach's Alpha	N of Items
.516	2

\a. Listwise deletion based on all variables in the procedure.

**Table 8.5: Analysis of Expert Review on Scalability of the Proposed Framework**

S/No.	Questions	Median	Decision
<b>Q13</b>	Is the ability to scale in respond to new information needs a requirement for framework for the development of integrated EMIS?	4.00	Strongly Agree
<b>Q14</b>	Does the EIS component of the proposed framework with interfaces to connect with other functional modules allows for scaling of the integrated EMIS with new information requirements?	4.00	Agree
<b>Decision Median</b>		<b>4.00</b>	<b>Agree</b>

The analysis of experts’ opinion to evaluate the proposed framework base on scalability of the integrated EMIS development is shown in Table 8.5. The result shows a decision median of 4.00, which indicates that the general opinion of experts agrees with the need and provision in the proposed framework to consider the scalability of the integrated EMIS development. This is necessary to respond to the increasing information needs of the education system by ensuring that the EIS component of the proposed framework exposes service interfaces to connect with other functional modules.

**F. Connectivity**

**Case Processing Summary**

		N	%
Cases	Valid	10	100.0
	Excluded <sup>a</sup>	0	.0
	Total	10	100.0

**Reliability Statistics**

Cronbach's Alpha	N of Items
.764	3

a. Listwise deletion based on all variables in the procedure.

**Table 8.6: Analysis of Expert Review on Connectivity of the Proposed Framework**

S/No.	Questions	Median	Decision
-------	-----------	--------	----------

<b>Q17</b>	Is connectivity between the EMIS application layer and the shared database to access and exchange data a requirement for the framework for integrated EMIS development?	4.00	Agree
<b>Q18</b>	Is the use of database management system like the MySQL adequate to manage access and retrieval of data in an integrated EMIS development framework?	4.00	Agree
<b>Q19</b>	Do you agree that the combination of the cache with the RESTful API that handles data requests is a useful technique of delivering efficient connectivity and data exchange in the development of integrated EMIS?	4.00	Agree
<b>Decision Median</b>		<b>4.00</b>	<b>Agree</b>

Table 8.6 shows the analysis of the expert review with reference to the connectivity requirement for the development of integrated EMIS. The decision median of 4.00 indicates that the general opinions of the experts agree to the need and provisions in the proposed framework for integrated EMIS functionalities to gain connectivity with shared databases for access and retrieval through RESTful API and Cache that enhances data requests handling.

#### G. Accessibility

		N	%
Cases	Valid	10	100.0
	Excluded <sup>a</sup>	0	.0
	Total	10	100.0

a. Listwise deletion based on all variables in the procedure.

Cronbach's Alpha	N of Items
.608	2

**Table 8.7: Analysis of Expert Review on Accessibility of the Proposed Framework**

S/No.	Questions	Median	Decision
<b>Q20</b>	Is accessibility to data for presentation a requirement in the design of framework for the development of integrated EMIS?	4.50	Agree
<b>Q21</b>	Does the provision of library of APIs that retrieve data from multiple sources to provide data analytics ensure data accessibility in the integrated EMIS development?	4.50	Agree

<b>Decision Median</b>	<b>4.50</b>	<b>Strongly Agree</b>
------------------------	-------------	-----------------------

The evaluation of the proposed framework base on the accessibility requirement is presented in Table 8.7. The analysis of the expert review indicates a decision median of 4.50. This shows that the general opinion of the experts strongly agreed with the provision in the proposed framework for the data accessibility in the development of integrated EMIS. This is to ensure data presentation in formats that meets specific users' needs using library of API to easily retrieve data from multiple data sources.

## **8.4 Comparative Analysis**

To further strengthen the evaluation of the proposed framework, to justify its effectiveness to the development of integrated EMIS, the qualitative method of comparative analysis is used. The application of comparative analysis to qualitative research study in information system is argued by Soto Setzke, Kavılı, & Böhm (2020) with the submissions that comparative analysis involves the adoption of methods such as the use of questionnaire, archival data and qualitative interview to collect datasets and the identification of influential configurational rationales as parameters and criteria for the comparison.

### **8.4.1 Approach and Procedure**

The method on the use of archival data that are presented and identified from the analysis of arguments in literature is considered relevant and adequate for this study. Meanwhile, the criteria for the comparative analysis are based on the requirements for the development of integrated EMIS as identified from the analysis of the research findings and discussed in Chapter 5 Section 5.5 of this thesis.

Meanwhile, Karamyshev (2017) raised arguments and submission for a four-stage approach and procedure for the use of comparative analysis. This is adapted for this study and presented thus:

#### **i. Literature Review:**

This involves the review of the literature on the two (2) relevant integration framework for EMIS development: Education Management Information Interoperability (EMIF) and School Interoperability Framework (SIF). The review is discussed in in Chapter 3

Section 3.5 and formed the benchmark for the comparison with the proposed framework.

**ii. Criteria Identification:**

The critical value proposition in the proposed framework is identified within the context of the six (6) requirements for the development of integrated EMIS as identified and discussed in Chapter 5 Section 5.5 of this thesis. The identified criteria represent the baseline for comparing the proposed framework with the EMIF and SIF.

**iii. Comparison Analysis:**

This stage involves the use of tabular approach to cross-reference the identified criteria under each requirement to compare the proposed framework against the EMIF and SIF.

**iv. Interpretation and Discussion:**

The tabular representation of the comparison of the proposed framework with the EMIF and SIF is discussed to raise arguments for the benchmarking.

#### **8.4.2 Comparative Criteria**

In essence, the discussions on the comparative analysis approach to the evaluation of the proposed framework is moderated within the context of the identification of the comparative criteria and its tabular representation. The criteria for comparing the proposed framework with the two (2) other EMIS integration frameworks, EMIF and SIF, is based on the key technical functionalities that defines the requirements for the development of integrated EMIS as discussed in Chapter 5 Section 5.5 of this thesis. These comparative criteria are evident in the case study demonstration of the proposed framework as discussed in the preceding Chapter 7 Section 7.4 of this thesis. As shown in the Table 8.8, the relevance and description of the comparative criteria are discussed thus:

**i. Central Information System**

Structured core functional module of the integrated EMIS that delivers the common information requirements of the education system. Other key functionalities of the integrated EMIS connects with the Central Information System (CIS) module. The emphasis is that the CIS is the design basis for achieving seamless EMIS integration.

**ii. Secured Channels**

Provision of a layer of security to ensure authentication and authorisation of access to running services within the CIS and extended functional modules. The implementation of the security and access control is through the roles and permission modules that wrap

services in layer of access restriction. The restriction is only relaxed, and access granted for users or calling services with appropriate permissions.

**iii. Customisation**

A method of the CIS demonstration that recognises the specific design requirements of the different education system and makes the integrated EMIS adaptable in design aesthetic to the different education system.

**iv. Simplified Technologies**

The simplicity of the associated techniques and technologies for the demonstration of technical framework for the design and development of integrated EMIS is a critical success factor that accelerates its adoption for use in the education system. The demonstration scenarios in this research study emphasised the use of simplified layered development technique and adopts the use of simplified RESTful services with lightweight data exchange mechanism as common technologies with flat learning curve for the EMIS development team.

**v. Structured Design**

The use of Service-Oriented Architecture as a standard design approach to the development of integrated EMIS fits into the needs of the education system to respond to changing and increasing information requirements. The SOA design approach ensures that the demonstration of the CIS in the integrated EMIS development connects with the extensible and scalable functional modules that deliver specific education task.

**vi. Multi-Tenant Cloud Service**

The need to optimally utilise resources for the integrated EMIS development requires that the host platform and infrastructure can be shared as service. The multi-tenant approach to the integrated EMIS development ensures that integration can be achieved with extension of the service infrastructure to support multiple instances of the integrated EMIS on shared cloud platform. This ensures that the integrated EMIS scales with new functional modules.

**vii. MVC Coding Logic**

The demonstration of the layered design architecture of the integrated EMIS is hinged on a development approach that separate the programming logic into manageable blocks of inter-connected codes. For a 3-tier design architecture, the Model-View-Controller (MVC) approach that separates the page view from the control logic and the database model is an appropriate standard for integrated EMIS development.

**viii. JSON Messaging Format**



The fundamental baseline for EMIS integration is the seamless exchange of data across functional modules and data sources. The communication of data requires serialisation of messages in format that can easily be transported through an end-to-end channel. The Java Script Object Notation (JSON) is a common light-weight messaging format that is significant for exchanging data in integrated EMIS.

**ix. Endpoint Connectivity**

The demonstration of the data exchange mechanism using the JSON messaging format requires the exposure of endpoints in functional modules of integrated EMIS to receive and response to data exchange requests. The endpoint interface, therefore, represents the point of connecting functional modules in integrated EMIS for data exchange.

**x. Extensible Interface**

The development of integrated EMIS needs to operate within the technical framework that make provision for the solution to scale with increasing demand for new information requirements. This requires provision of interfaces in the functional modules of the integrated EMIS to scale and extend with new functionalities.

**xi. Shared Storage**

In the layered integrated EMIS architecture, the backend handling is largely rested on the mechanism and technique for data storage. As each functional and extensible module of the integrated EMIS maintains separate database, there is the need for a shared database system to keep common data structure that connects each functional module in the integrated EMIS. This simplifies the integration and exchange technique of the integrated EMIS framework.

**xii. Enhanced Access and Retrieval**

Enhancing the connectivity of the functional logic in the integrated EMIS to the backend database requires a method of access and retrieval of data that ensure prompt response to data requests. This can be achieved with the use of cache that promptly respond to request for frequently accessed data.

**xiii. Cross-Platform Analytic**

Integrated EMIS with extensive functional modules that deliver automation of different education tasks requires a mechanism for accessibility to data analytic across platforms. This is enhanced with the framework that consider shared database and RESTful APIs for data exchange and communication.

### 8.4.3 Comparison and Discussions

Table 8.8 shows a qualitative comparative analysis of the proposed framework with two (2) other EMIS integration frameworks, EMIF and SIF, using the criteria from the six (6) requirements for integrated EMIS development as comparative benchmark for evaluation. The requirements are categorised into Adaptability, Maintainability, Standardization, Scalability, Connectivity and Accessibility. The criteria for the comparison are carefully indicated, within the context of their description and relevance to this study, as: Addressed; Partially Addressed; and, Not Addressed.

**Table 8.8: Comparative Analysis of Proposed Framework with EMIF and SIF based on Identified Criteria.**

Requirement	Criteria	Proposed Framework	EMIF	SIF
Adaptability	Central Information System (CIS)	√	↔	↔
	Customisation	√	×	×
Maintainability	Simplified Technologies	√	×	↔
Standardisation	Structured Design	√	√	√
	Coding Logic	√	√	↔
	Communication Channel	√	√	√
Scalability	Endpoint Connectivity	√	√	√
	Extensible Interface	√	√	√
Connectivity	Shared Storage	√	↔	↔
	Enhanced Access and Retrieval	√	√	√
Accessibility	Cross-Platform Analytics	√	√	√
Indications	√ = Addressed    ↔ = Partially Addressed    × = Not Addressed			

In terms of *Adaptability* requirement criteria, the proposed framework is compared with the EMIF & SIF frameworks base on the provision of Central Information System (CIS) that considers the specific and common information needs of the education system with

customisable setting. In both EMIF and SIF, there is no provision for customisation that allow for the specific information structure of the different education system. The recognition and provision of customisation with CIS that extend beyond inter-connecting services to functional core modules for handling the common and specific information structure of the different education system is the thrust and major contribution of the proposed framework to the development of integrated EMIS. Thus, the proposed framework is more adaptable to the education system when compared to the EMIF and SIF.

Regarding the *Maintainability* requirement as criteria for the comparative analysis, the use of simple and familiar technologies like the RESTful API service and JSON as standard for data communication and exchange are values that align the proposed framework with the SIF. Meanwhile, the EMIF is built on the complex technology of the Web Services and XML for data communication and exchange. The complexity of the technology that is used for framework recommendation limits its adoption for use by the EMIS developers in the education system because of the knowledge limitation and constraint.

In the context of *Standardisation* requirement as comparative benchmark, the proposed framework align with the EMIF and SIF in the use of Service-Oriented Architecture (SOA) as design approach that can drive EMIS integration with standard messaging format for data exchange. Meanwhile, the proposed framework and the EMIF address the need for clear standard programming logic for EMIS development and data exchange mechanism, but the SIF only standardise the access to data through RESTful API for local consumption using programming logic of the EMIS vendor.

In terms of the *Scalability* requirement as comparative benchmark, the proposed framework align with the specifications and considerations of the EMIF and SIF with consideration for endpoint connectivity and extensible interface. The endpoint connectivity is facilitated by the RESTful API library that can be called and consumed by other functional module to exchange data. Meanwhile, the SOA design approach use the endpoints of the REST API to extend interface for integration with other EMIS functional modules.

The *Connectivity* requirement is another benchmark for the comparative analysis using such criteria as the provision of shared database and enhance system for access and retrieval of data. The proposed framework considered a shared database that registered and stored data relating to the extensible functional modules of the integrated EMIS. It also keeps structured data of

common and specific information of the education system that other extensible functional modules can consume to strengthen the integration. Meanwhile, the shared database of the EMIF and the SIF only register and store the service information of the ZIS and the functional modules of the integrated EMIS. However, the proposed framework aligned with the EMIF and SIF with provision of mechanism for enhancing access and retrieval of stored data.

In terms of the *Accessibility* requirement as comparative benchmark, the proposed framework also align with the EMIF and SIF base on the comparative criteria of consideration for cross-platform analytic. The cross-platform analytic provides for visualisation of data from multiple sources using the technology provision of the services and data exchange mechanisms to provide qualitative information for decision-making process.

In essence, the comparative analysis for the evaluation of the proposed framework based on the thirteen (13) criteria that are identified and categorised under six (6) requirements for integrated EMIS development revealed some areas of alignment and distinction between the proposed framework and the two (2) existing frameworks, EMIF and SIF. The key distinction from the comparative analysis is the criteria under the *Adaptability* requirement benchmark where the proposed framework extends the CIS to address customisation, which makes provision for the difference in the specific information requirement of different education system. The other distinction is in the *Standardisation* requirement with the consideration for the cloud platform with multi-tenancy approach to demonstrating EMIS integration.

## **8.5 Closing Remark**

This chapter reviewed the evaluation of the proposed service-oriented technical framework for the development of integrated EMIS. The focus is to partly answer the fifth research question for this study:

- v. How can the design of a service-oriented technical framework for the development of integrated EMIS be demonstrated and evaluated?**

The demonstration part of the fifth research question is already answered in the preceding chapter, Chapter 7. In answering the evaluation part of the research question, the chapter justified the essence of the evaluation and considered two (2) methods for the evaluation approach. The essence of the evaluation is to examine the effectiveness of the proposed

framework using the structured approaches and methods of expert review and comparative analysis.

The expert review considered the analysis of the feedback from ten (10) practice experts through close-ended questionnaires on key functionalities from the case study demonstration that satisfy each of the six (6) requirements for the development of integrated EMIS. Meanwhile, the comparative analysis benchmark the proposed framework with two (2) other existing EMIS integration frameworks based on thirteen (13) identified criteria from the six (6) requirements for the development of integrated EMIS.

The expert review process of the proposed framework evaluation involved the collection of responses through close-ended questionnaire using the Likert scale. The analysis of the responses and the interpretations are based on the determination of the median, as a measure of central tendency, on each area of the questionnaire using SPSS software. From the result of the analysis, it is evident that the expert review affirms the effectiveness of the proposed framework base on its justification, adaptability, maintainability, standardisation, scalability, connectivity, and accessibility for integrated EMIS development.

Meanwhile, the comparative analysis as a method of evaluation benchmarked the proposed framework against two other EMIS integration frameworks, EMIF and SIF. The process involved the identification of comparative criteria from the six (6) requirements for integrated EMIS development. The comparison was based on the thirteen (13) criteria: Central Information System, Secured Channel, Customisation, Simplified Technologies; Structured Design, Cloud Service, Coding Logic, Communication Channel, Endpoint Connectivity, Extensible Interface, Shared Storage, Enhanced Access, and Retrieval, and Cross-Platform Analytic. The conclusion from the comparative analysis indicated some areas of commonality and distinctions between the proposed framework, EMIF and SIF. The areas of distinction are evident in the Adaptability and Standardisation requirement benchmark with respective criteria on Customisation and Cloud Service provisions of the proposed framework. These key distinctive areas represent the key areas of contributions of the proposed framework to the development of integrated EMIS.

With the evaluation of the proposed framework identifying its effectiveness, the next chapter summarised and articulates the research contributions.

## CHAPTER 9 : SUMMARY, CONCLUSION AND FUTURE WORK

This chapter summarizes the research thesis by reviewing the arguments for the research problems and questions that inspired this study, and the extent to which they were addressed in the proposed service-oriented technical framework for the development of integrated EMIS. The arguments are organized into sections under this chapter as shown in Figure 9.1.

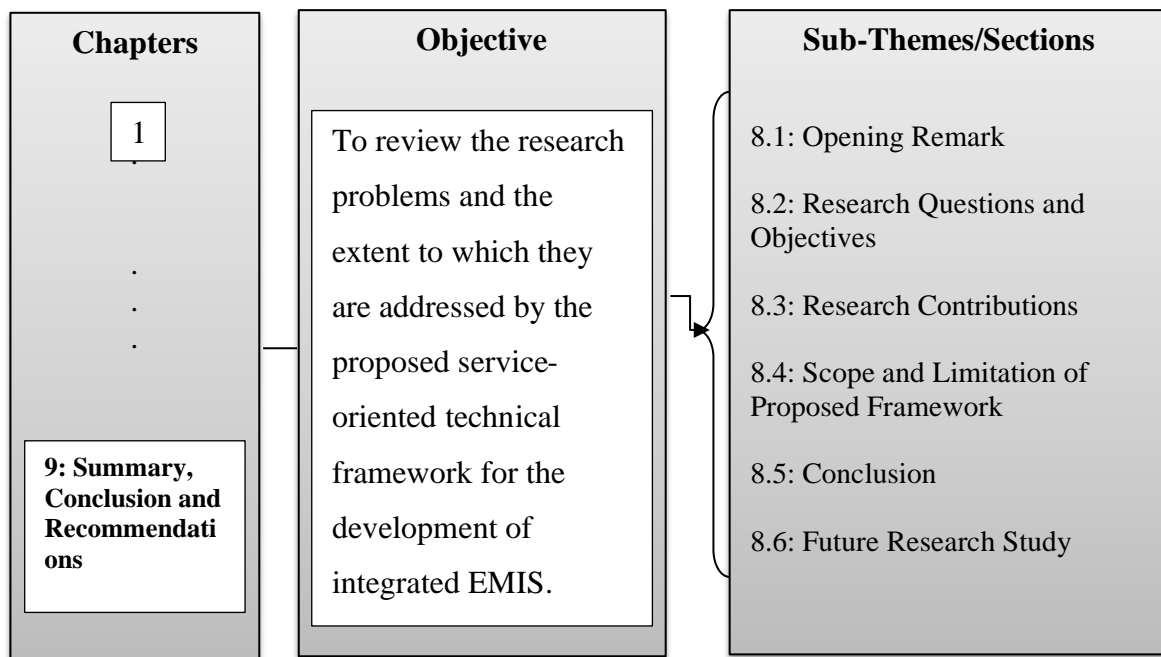

Figure 9.1: Objective Overview of Chapter Nine

The Introduction subtheme (Section 9.1) contextualizes the significance of research problem in evaluating the proposed technical framework for the development of integrated EMIS. The subtheme on Research Questions and Objectives (Section 9.2) summarizes this research study by reviewing and re-connecting the research questions to the research objectives. The Research Contribution subtheme (Section 9.3) identifies and describes the contribution of this research study to the body of knowledge.

Meanwhile, the subtheme on Scope and Limitation of Proposed Framework (Section 9.4) identifies and discusses the areas of strength and weakness of the proposed framework within the context of the case study demonstration. The Conclusion subtheme (Section 9.5) articulate arguments in this thesis to justify the basis and outcome of the research study. However, the Future Research Study subtheme (Section 9.6) raise arguments on areas that are not covered in this research study and still open to further investigation.

## **9.1 Opening Remark**

This chapter finalizes this research study thesis; the structure of which is discussed in section 1.11 of this thesis. It summarizes the study by justifying the connections between the research questions and objectives that motivated this study. The research questions are then reviewed within the context of the extent to which they are addressed in this study.

The essence of the research study is to investigate, design, implement and evaluate a proposed framework for the development of integrated EMIS. Thus, the argument for the proposed framework is revisited to identify the key outcome of the research study. This is articulated as the main contributions of this study to the body of knowledge in the development integrated EMIS.

While attempt was made to ensure that the framework is adequate to address the research objectives that are identified in this study, the scope and limitations of the proposed framework are identified and discussed. The discussion, therefore, provided a basis for further discussion on further research work that could be addressed in future research.

## **9.2 Research Questions and Objectives**

The education system requires deployment of education management information system (EMIS) with capacity to exchange data across various modules that manage the various education tasks for optimal efficiency of the school system. However, achieving cross platform data exchange in EMIS, especially in developing Africa countries like Nigeria, is limited by these challenges: (1) the use of complex data communication and exchange technologies of existing EMIS integration framework like the EMIF and SIF; (2) absence of a standard design framework for the development of EMIS that can easily and seamlessly exchange data; (3) limited knowledge and awareness on the use of advance technology for achieving data exchange.

In this study, therefore, the challenges are addressed with the consideration for simplified and standard technologies and techniques to answer the main research question that connect with the main research objective. For purposes of clarity and details, the main research question and objective are resolved into specifics questions and objectives. This is represented in the Figure 9.2

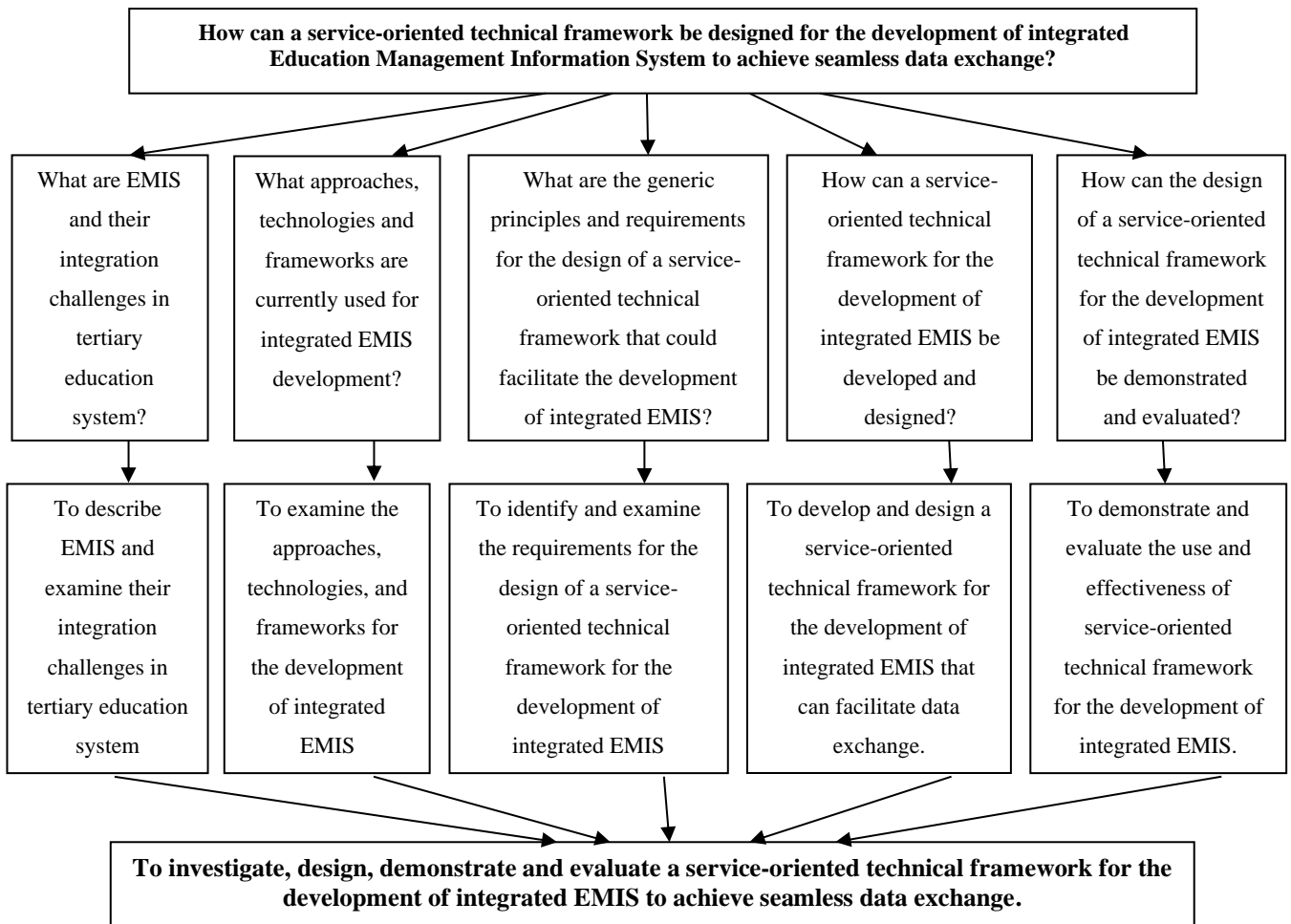

Figure 9.2: Linkage between the Research Questions and the Research Objectives

In this study, however, each of the specific research questions is addressed in separate chapter of this thesis with conclusion on the clear corresponding objective that is achieved. The summary of arguments for each of the specific research questions (SRQ) and the corresponding objective is presented thus:

**SRQ1:** What are EMIS and their integration challenges in tertiary education system?

This research question is addressed in Chapter 2 of this thesis with strength of arguments from the review of literatures on EMIS, using content analysis to shape the focus of the argument base on thematic around the detailed description of EMIS; its different forms in tertiary education system, especially in Nigeria context; design considerations for EMIS development; and benefits and challenges of EMIS to tertiary education system.

In addressing the corresponding research objective, therefore, the answer to this SRQ described EMIS as a form of information system for managing the flow of data at the different levels of



the education system. However, effective use of EMIS is limited with inherent challenge of exchanging data across various EMIS platforms.

Meanwhile, the design considerations for the development of integrated EMIS that can seamlessly exchange data is further discussed in Chapter 5 Section 5.4 based on analysis of the research findings.

**SRQ2:** What approaches, technologies and frameworks are currently used for integrated EMIS development?

In identifying and reviewing existing approaches, technologies, and frameworks for the development of integrated EMIS that address the data exchange challenge, a review of literature was conducted. The literature review approach used content analysis to gain insight into the considerations for EMIS integration; design approaches and standard technologies for achieving EMIS integration; review of selected integration frameworks within the context of their benefits and limitations to achieving data exchange; and review of case study application of some standard technologies to achieving EMIS integration and their limitations. These are discussed Chapter 3 of this thesis.

Furthering the understanding on the description of EMIS and the data exchange challenge, the objective focus in this SRQ examined the approaches of Enterprise Application Integration (EIA) and Service-Oriented Architecture (SOA) with such technologies as Web Services, Semantic Web and Web Application Programming Interface for achieving EMIS integration. Meanwhile, Education Management Information System Interoperability Framework (EMIF) and School Interoperability Framework (SIF) were examined as existing frameworks for development of integrated EMIS that can ensure data exchange. These frameworks, however, use standard technologies with complex communication channels to achieve data exchange.

**SRQ3:** What are the generic requirements and principles for the design of a service-oriented technical framework that could facilitate the development of integrated EMIS?

Realising that there is need for a standard framework with simplified technology approach to the development of integrated EMIS that can seamlessly exchange data, it was important to gain understanding of the reality of the structure and process of EMIS integration in the education system. A survey of the education system in selected sample space approach was considered as approach to this SRQ to investigate the research study.

Thematic analysis of responses to semi-structure interviews of participants from purposively selected tertiary education institutions in Nigeria was used to set direction for arguments to answer this SRQ. The approach raised discussions, as provided in Chapter 4 of this thesis, on the design structure, approach, process, platform, standard, significance, and data exchange mechanism in the development of integrated EMIS. Inductive reasoning analysis was further applied to review these thematic issues and formed the basis for answering this SRQ.

In achieving the corresponding objective to this SRQ, twelve (12) principles and six (6) requirements for the design and development of integrated EMIS were identified from the thematic issues. Meanwhile, the principles provide guides for: Development Processes, Design Structure, Design Standard, Data Exchange, Development Platform, Integration Approach, and Significant Value of EMIS. However, the requirements identify the benchmark for the framework design to include: (1) Adaptability to specific education system; (2) Maintainability of the EMIS development process; (3) Standardisation of techniques and technologies for EMIS development; (4) Scalability of the EMIS to new requirement; (5) Connectivity of the EMIS to data sources for data exchange; (6) Accessibility of the EMIS to users' needs in term of data presentation.

Noteworthy, the principle and requirements are discussed in Chapter 5 of this thesis and formed the basis for the design and evaluation of the proposed framework.

**SRQ4:** How can a service-oriented technical framework for the development of integrated EMIS be designed?

This SRQ is addressed in Chapter 6 of this thesis and on the strength of argument that is provided in the discussions in Chapter 5 of this thesis, which identified the principles and requirements for the design framework for integrated EMIS development. The approach involved a conceptualisation of the key technical elements of the thematic areas that formed the basis for the design principles and establishing the relationship among the elements. The objective is to design and implement a proposed framework that use simplified and common technologies for achieving the development of integrated EMS that can easily and seamlessly exchange data across various functional modules that deliver different education tasks.

Inductive reasoning analysis of the thematic areas of the design principles was conducted to identify key technical elements relevant to integrated EMIS development. These component elements were then re-grouped to identify technical concepts. The framework, therefore, was

designed as a model of inter-connected technical concepts with lines of relationships that define layer of connection between components in each conceptual block.

Thus, the following layer of inter-connected conceptual components represent the proposed technical framework: (1) Education Information Structure (EIS) that handles users and school information with layer of Access Control for handling authorization and authentication; (2) Service-Oriented Design layer that handles connection of integrated EMIS functional modules to the EIS; (3) Demonstration Logic layer that handles the programming logic of the EMIS development process to scale with new information requirements; (4) Data Exchange Mechanism that provides a layer of standard data serialization format to exchange data; (5) Database System layer that handles data storage and retrieval services.

A case study demonstration of this proposed framework is discussed in Chapter 7 of this thesis to check the effectiveness of the proposed framework at addressing the data exchange challenge in the education system.

**SRQ5:** How can the design of a service-oriented technical framework for the development of integrated EMIS be evaluated?

The case study demonstration of the proposed framework necessitated the need for further validation using the expert review, comparative analysis and review against the requirements from the research findings. This SRQ, therefore, is addressed in discussions on framework evaluation in Chapter 8 of this thesis.

The approach considered expert review of the case study demonstration based on the key components of the proposed framework and raised discussion based on feedback from analysis of close-ended questionnaires. In another context, a set of distinguishing parameters were set to benchmark the proposed framework with other existing EMIS integration frameworks. The comparative analysis then justified the value proposition and knowledge contribution of the proposed framework. These values are defined as:

To check consistency with the research findings, the framework was again evaluated against the identified requirements for the design of technical framework for the development of integrated EMIS: Adaptability, Maintainability, Standardisation, Scalability, Connectivity and Accessibility.

### **9.3 Research Contributions**

The significance of this research study is discussed in Section 1.6 of this thesis and the emphasis is on its ability to serve a useful guide for the development of integrated EMIS that deliver enterprise system functionalities, which aid seamless data exchange. The outcome of the research study, which is a demonstrable service-oriented technical framework for the development of integrated EMIS, delivers on this significance. This is evident from the case study demonstration and form the basis for the contributions that this research study is able to make. For emphasis, the research contributions are highlighted as:

- i. A clear description for integrated EMIS in tertiary education system
- ii. Contextual technical considerations for setting clear objectives for the design and development of integrated EMIS.
- iii. A Clear set of guiding principles and essential requirements for the design and development of integrated EMIS.
- iv. A simplified conceptual design approach for standardizing the development of EMIS as an integrated system with extensible functionalities for integration of new EMIS modules.
- v. An inter-connected layered framework of key technical components for the design and development of integrated EMIS that addresses the data exchange challenge in EMIS integration

In essence, the proposed framework addresses the challenge of data exchange in EMIS integration by providing a service-oriented design approach that conceptualize EMIS as an integrated system with extensible functionalities that use standard technologies and techniques to seamlessly exchange data.

### **9.4 Scope and Limitation of Proposed Framework**

The scope and limitation of this study is discussed in Chapter 1 Section 1.9 of this study and provides the bound for the proposed technical framework. The framework simplifies the complexity in the data exchange mechanism of integrated EMIS and standardise its design and development process. Thus, the framework addresses the main research objective that is set in Chapter 1 Section 1.5 of this thesis.

However, regarding the focus of integration as discussed in Chapter 3 Section 3.2.1 of this thesis, the framework addresses the integration focus from the perspectives of scalability and

interoperability based on data exchange. Meanwhile, the integration consideration for performance in the proposed technical framework is limited to the extent of what scalability can achieve. In essence, therefore, the proposed framework is limited in the context of the following areas:

- i. **Access Control Security:** The authentication and authorisation security layer of the CIS is limited to the control of users' access with roles and permissions and does not cover the end-to-end interactions among the API services.
- ii. **Limited Exchange Format:** Communications among services only consider the JSON exchange format and is limited to internal data communication and exchange among functional modules of the integrated EMIS. External data exchange communication might require another layer of data format for exchange.
- iii. **Custom Settings:** The provision for personalized custom settings functionality within the CIS layer to address the specific information requirements of each education system is adequate but might be limited in the circumstance where the information structure of an education institution is largely at variance with other tenant institutions.

## **9.5 Conclusion**

This chapter summarizes the research study thesis with the review of the main and specific research questions. The articulation of answers to these questions forms the basis for the contribution that this study is able to make to the body of knowledge in such areas as: Service-Oriented Technical Framework, Education Management Information System, Integrated EMIS Development, EMIS Functional Modules, Education Information Structure, Service-Oriented Design, Data Exchange Mechanism, EMIS Demonstration Logic, Database System, and Framework Evaluation Requirements.

The case study demonstration and evaluation of the research outcome indicated that the research outcome was able to substantially meet the main research objective of designing a service-oriented technical framework for the development of integrated EMIS that simplifies and eases the data exchange challenge of EMIS integration. However, the limitations of the proposed framework are identified for further research study.

It is noteworthy, however, that the research outcome of this study will serve a useful guide for EMIS developers in education institutions to understand the inter-connections of key components that shape the development of integrated EMIS.

## 9.6 Future Research

Overall, the research objectives that are set out in Chapter 1 Section 1.5 of this thesis were accomplished. However, the proposed solution framework could still be improved to address some of the limitations identified during the demonstration and evaluation phase. These, therefore, represent areas of future research work to further enhance the proposed framework:

i. Customizing and Enhancing Security Layer

The demonstration of the Authentication and Authorization layer of security in the proposed framework is executed at the EIS layer and is only able to handle access permissions on users' activities within the integrated EMIS framework. This layer of security can be further researched to extend the security to the interaction among services. This could further improve on the framework security to detect and guide against intrusions that are capable of phishing on exchanged data during communication.

ii. Providing for Multiple Data Exchange Format

The mechanism for data exchange explores the use of JSON format to serialize and deserialize data during exchange. This only considers the data exchange as activities within the internal structure of the multi-tenant integrated EMIS. The publication of the API services in a library is good practice to ensure that communication among services explore and consume available services to exchange data in right and expected format. However, this format of exchange is limited and cannot handle external communications that use and expect different data format for exchange. Further research, however, could explore the provision of a layer within the exchange mechanism component of the proposed framework that request choice of the exchange format and then activate the data exchange in the specified format. A much seamless switch, using intelligence system layer, to the appropriate exchange format could be explored in future research.

iii. Extending the Customization to Functional Modules Level

The demonstration of the proposed framework considered the custom setting functionality at the CIS level of the EIS component of the proposed framework. This custom setting functionality provides the flexibility for each education institution to implement specific information requirement and personalize the environment of the integrated EMIS platform. Beyond the customization at the CIS level, there could be specific difference in the logic flow of the information requirement in the demonstration

of the functional module that extend the CIS. Thus, further research work could be carried out to determine the extent and dynamics of customization of information requirements that is expressible in the education system. Extending the customization to functional module level could make the demonstration of the design and development framework of the integrated EMIS much complex. But further research study could explore simplified design approach to extend the design structure of the EIS to capture the interactions among key education activities in the education system at the service design layer of the proposed framework.

## REFERENCES

- Abdul-Hamid, H. (2014). *What Matters Most for Education Management Information Systems: A Framework Paper*. World Bank Group.
- Abubakar, S. M., Uzoma, A. O., & Simon, A. P. (2015). A Review of Data Access Optimization Techniques in a Distributed Database Management System. *International Journal of Computer Applications Technology and Research*, 4(7), 529 - 534.
- Access 4 Learning Community. (2018, December 5th). *The SIF Specifications*. Retrieved from Access 4 Learning Community: <https://www.a4l.org/page/SIFSpecifications>
- Ahmad, F., & Tsang, T. (2012, February 12). *The Melody of Quality Measures: Harmonize and Standardize*. Retrieved from Health Affairs Blog: <http://healthaffairs.org/blog/2012/02/21/the-melody-of-quality-measures-harmonize-and-standardize/>
- Ahmed, M. D., & Sundaram, D. (2011). Design Science Research Methodology: An Artefact-Centric Creation and Evaluation Approach. *22nd Australasian Conference on Information Systems* (pp. 1-10). Sydney: AIS Electronic Library (AISeL).
- Alamri, S., Abdullah, M., & Albar, A. (2019). Enterprise Architecture Adoption for Higher Education Institutions . *International Journal of Simulation: Systems, Science and Technology*, 1-8.
- Ali, S. M. (2013). Strategic Requirements of Higher Education Management Information System. *Collnet Journal of Scientometrics and Information Management*, 145 - 155.
- Al-Yaseen, W. L., Othman, Z. A., & Nazri, M. Z. (2016). A Large Data Exchange Method for Multi-agent in Java Agent Development Framework. *International Review of Management and Marketing*, 6(S8), 27-32.
- Andary, J. F., & Sage, A. P. (2010). The role of service oriented architectures in systems engineering. *Information Knowledge Systems Management*, 9, 47-74.
- Aserey, N., & Alshawi, S. (2013). A CONCEPTUAL MODEL OF ENTERPRISE APPLICATION INTEGRATION IN HIGHER EDUCATION INSTITUTIONS. *European, Mediterranean & Middle Eastern Conference on Information Systems*. Windsor, United Kingdom.
- Bahaa, A., Sayed, A., & Elfangary, L. (2018). A Secured Interoperable Data Exchange Model. *International Journal of Advanced Computer Science and Applications*, 9(1), 253-260.
- Baharein, K., & Noor, M. (2008). Case Study: A Strategic Research Methodology. *American Journal of Applied Sciences*, 5(11), 1602-1604.
- Balasubramaniam, S., & Kavitha, V. (2013). A Survey on Data Retrieval Techniques in Cloud Computing. *Journal of Convergence Information Technology (JCIT)*, 8(16), 15 - 24.
- Bank, W. (2016). *Education Management Information Systems*. Retrieved from [worldbank.org: https://wbfiles.worldbank.org/documents/hdn/ed/saber/supporting\\_doc/brief/SABER\\_EMS\\_Brief.pdf](https://wbfiles.worldbank.org/documents/hdn/ed/saber/supporting_doc/brief/SABER_EMS_Brief.pdf)
- Barchci, M., Klein, M., Longstaff, T., & Weinstock, C. (1995). *Quality Attributes*. Pittsburgh, PA, 1995: Software Engineering Institute, Carnegie Mellon University.
- Baskerville, R., Baiyere, A., Gregor, S., Hevner, A., & Rossi, M. (2018). Design Science Research Contributions: Finding a Balance between Artifact and Theory. *Journal of the Association for Information Systems*, 19(5), 358-376.



- Baxter, P. E., & Jack, S. M. (2008). Qualitative Case Study Methodology: Study Design and Implementation for Novice Researchers. *The Qualitative Report*, 13(4), 544-559.
- Berners-Lee, T., Chen, Y., Chilton, L., Connolly, D., Dhanaraj, R., Hollenbach, J., . . . Sheets, D. (2006). Tabulator: Exploring and Analyzing linked data on the Semantic Web. *Proceedings of the 3rd International Semantic Web User Interaction*. Georgia, USA.
- Bertino, E., Martino, L. D., Paci, F., & Squicciarini, A. C. (2010). Web Service Technologies, Principles, Architectures, and Standards. In *Security for Web Services and Service-Oriented Architectures* (pp. 9 - 23). Springer Berlin Heidelberg.
- Bisaso, R., & Visscher, A. (2005). Computerised School Information Systems Usage in an Emerging Country - Uganda. In *Information Technology and Educational Management in the Knowledge Society* (Vol. 170, pp. 81 - 97). Spain: Springer.
- Bitar, I. E., Belouadha, F.-Z., & Roudies, O. (2014). Semantic Web Service Discovery Approaches: Overview and Limitations. *International Journal of Computer Science & Engineering Survey (IJCSSES)*, 5(4), 21-36.
- Bloebaum, T. H., & Lund, K. (2012). CoNSIS: Demonstration of SOA Interoperability in Heterogeneous Tactical Networks. *Communications and Information Systems Conference (MCC)* (pp. 1 - 7). Gdansk, Poland: IEEE.
- Carapina, M., Stanicic, O., & Nozica, B. (2013). The Semantic Web Technologies and Their Integration Within e-Learning Systems: An Overview. *Proceedings of ICERI2013 Conference*, (pp. 3795-3801). Seville, Spain.
- Carrizo, L., Sauvageot, C., & Bella, N. (2003). *Information Tools for the Preparation and Monitoring of Education Plans*. Paris: UNESCO.
- Carroll, N., & Richardson, I. (2016). Aligning Healthcare Innovation and Software Requirements through Design Thinking. *Proceedings of the International Workshop on Software Engineering in Healthcare Systems* (pp. 1-7). ACM.
- Castano, S., Palopoli, L., & Torlone, R. (2000). A General Methodological Framework for the Development of Web-Based Information Systems. In *Conceptual Modelling for E-Business and the Web* (pp. 128 - 139). Springer-Verlag.
- Casteleyn, S., Daniel, F., Dolog, P., & Matera, M. (2009). Web Application Design. In *Engineering Web Applications: Data-Centric Systems and Applications* (pp. 115 - 174). Springer-Verlag.
- Castillo, P., Bernier, J., Arenas, M., Merelo, J., & Garcia-Sanchez, P. (2011). SOAP vs REST: Comparing a master-slave GA implementation. *CoRR*, vol. abs/1105.4978.
- Caulfield, J. (2019, September 6). *How to do thematic analysis* . Retrieved from Scribbr: <https://www.scribbr.com/methodology/thematic-analysis/>
- Chandio, A. A., Zhu, D., & Sodhro, A. H. (2012). Integration of Inter-Connectivity of Information System (i3) using Web Services. *International MultiConference of Engineers and Computer Scientists, I*. Hong Kong.
- Chang, C. C., & Hsiao, K.-C. (2011). A SOA Based e-Learning System for Teaching Fundamental Information Management Courses. *Journal of Convergence Information Technology*, 6(4), 298 - 305.
- Chang, F., Dean, J., Ghemawat, S., Hsieh, W. C., Wallach, D. A., Burrows, M., . . . Gruber, R. E. (2008). Bigtable: A Distributed Storage System for Structured Data. *ACM Transactions on Computer Systems (TOCS)*, 26(2), 1 - 26.
- Chasseur, C., Li, Y., & Patel, J. M. (2013). Enabling JSON Document Stores in Relational Systems. *WebDB*, (pp. 1 - 6). New York USA.
- Chau, T., & Maurer, F. (2005 (9)). Integrated Process Support and Lightweight Knowledge Sharing for Agile Software Organizations.

- Chauhan, E., & Asthana, A. (2017). Review of Indexing Techniques in Information Retrieval. *International Journal of Engineering Science and Computing*, 7(7), 13940 - 13942.
- Chemuturi, M. (2013). *Requirements Engineering and Management for Software Development Projects*. New York: Springer.
- Chen, J., Chen, Y., Du, X., Li, C., Lu, J., Zhao, S., & Zhou, X. (2013). Big Data Challenge: a data management perspective. *Frontiers of Computer Science*, 7(2), 157 - 164.
- Chen, Y.-C., & Hsieh, T.-C. (2014). Big Data for Digital Government: Opportunities, Challenges and Strategies. *International Journal of Public Administration in Digital Age*, 1(1), 1-14.
- Chotisarn, N., & Sanpote, D. (2017). A Demonstration Case Study of Software Engineering Senior Project Coordinating the International Standard. *International Conference on Digital Arts, Media and Technology (ICDAMT)*, (pp. 314-319).
- Clark, R. G. (2013). Sample Design using Imperfect Design Data. *Journal of Survey Statistics and Methodology*, 1(1), 6 - 23.
- Clark, W., & Golder, M. (2014). "Big Data, Causal Inference, and Formal Theory: Contradictory Trends in Political Science? *Political Science and Politics* 48(1), 65-70.
- Clarke, V., & Braun, V. (2013). *Successful qualitative research: A practical guide for beginners*. London: SAGE.
- Closa, D., Gardiner, A., Giemsa, F., & Machek, J. (2010). Database and Database Management System. In *Patent Law for Computer Scientists* (pp. 75 - 87). Springer Berlin Heidelberg.
- Colomo-Palacios, R., Casado-Lumbreras, C., Soto, P., Misra, S., & Garcia, F. (2012). Analyzing Human Resource Management Practices Within the GSD Context. *Journal of Global Information Technology Management*, 30-54.
- Consortium, I. G. (2021, June 23). *Abstract Framework*. Retrieved from Abstract Framework: <http://www.imsglobal.org/af/index.html>
- Correia, F. F., & Aguiar, A. (2019). Software Knowledge Capture and Acquisition: Tool Support for Agile Settings. *IEEE Computer*.
- Creswell, J. W. (2009). *Research Design: Qualitative, Quantitative, and Mixed Methods Approaches*. London: SAGE.
- D. Chen, G. D. (2008). "Architectures for enterprise integration and interoperability: . 647-659.
- Damin, R., Kadry, M., & Hamed, E. (2014). An investigation into the use of the Education Management Information System (EMIS) in Iraq: Case study. *International Conference on Engineering and Technology (ICET)* (pp. 1 - 6). Cairo: IEEE.
- Dekleva, S. (1992). The Influence of the Information systems development approach on maintenance. *MIS Quarterly* 16 (3), 355-372.
- Desouza, K. (2014). *Realizing the Promises of Big Data: Implementating Big Data Projects*. Washington, D.C: The IBM Center for the Business of Government.
- Dongdai, Z., Ling, Q., Pan, X., Zhuo, Z., & Hongyan, T. (2010). SOA-based Education Information System Interoperability Model. *Journal of Information & Computational Science*, 7(5), 1165 - 1174.
- Duan, R., & Zhang, M. (2007). Design f a Web-based Management Information System for Academic Degree & Graduate Education. *International Federation for Information Processing*, 252, 218-226.
- Ekundayo, H., & Ajayi, I. (2009). Towards Effective Management of University Education in Nigeria. *International NGO Journal*, 4(8), 342-347.
- Emmersberger, C., & Springer, F. (2013). Tutorial: Open Source Enterprise Application Integration: Introducing the Event Processing Capabilities of Apache Camel.

- International Conference on Distributed Event-Based Systems*, (pp. 259 - 268). Texas, USA.
- Eriksson, M., & Hallberg, V. (2011). *Comparison between JSON and YAML for Data Serialization*. The School of Computer Science and Engineering Royal Institute of Technology.
- Erl, T. (2008). *Principles of Service Design*. USA: PRENTICE HALL.
- Espinha, T., Zaidman, A., & Gross, H.-G. (2014). Web API Growing Pains: Stories from Client Developers and Their Code. *CSMR-WCRE* (pp. 84-93). Antwerp, Belgium: IEEE.
- Fazlollahi, A., Franke, U., & Ullberg, J. (2012). Benefits of Enterprise Integration: Review, Classification, and Suggestions for Future Research. In *Enterprise Interoperability* (pp. 34 - 45). Springer.
- Fenner, J. (2011). *Enterprise Application Integration Techniques*.
- Foxwell, M., & Peacock, K. (2015). Industry Standard for Good Programming Practice: Benefits and Implementation. *PhUSE 2015*, (pp. 1-6).
- François, B. V. (2009). Enterprise Integration and Interoperability. In S. Y. Nof, *Springer Handbook of Automation* (pp. 1529-1538). Springer Berlin Heidelberg.
- Fu, K. K., Yang, M. C., & Wood, K. L. (2016). Design Principles: Literature Review, Analysis, and Future Directions. *Journal of Mechanical Design*, 138, 1-13.
- Fu, X., & Liu, Q. Y. (2010). Design and Implementation of University Level Unified Information System Integration Platform. *5th International Conference on Computer Sciences and Convergence Information Technology (ICCIT)* (pp. 864 - 868). Seoul: IEEE.
- Gartner. (2011, March 01). *Pattern-Based Strategy: Getting Value from Big Data*. Retrieved from gartner.com: <https://www.gartner.com/doc/1727419/>
- Geric, S. (2010). The Potential of Service-Oriented Architecture. *32nd International Conference on Information Technology Interfaces*, (pp. 471 - 476). Cavtat, Croatia.
- Ghazarian, A., Tehrani, M. S., & Ghazarian, A. (2011). A Software Requirements Specification Framework for Objective Pattern Recognition: A Set-Theoretic Classification Approach. *16th IEEE International Conference on Engineering of Complex Computer Systems* (pp. 211-220). IEEE Computer Society.
- Gilal, A. R., Jaafar, J., Omar, M., Basri, S., & Aziz, I. A. (2016). Balancing the Personality of Programmer: Software Development Team Composition. *Malaysian Journal of Computer Science*, 29(2), 145-155.
- Golafshani, N. (2003). Understanding Reliability and Validity in Qualitative Research. *Qualitative Report*, 8(4), 597-606. Retrieved from The Qualitative Report: <http://nsuworks.nova.edu/tqr/vol8/iss4/6>
- Gondal, A., & Khan, A. (2008). Impact of Team Empowerment on Team Performance Case of The Telecommunications Industry in Islamabad. *International Review of Business Research Papers*, 4(5), 138-146.
- Gray, D. E. (2014). *Doing Research in the Real World*. SAGE.
- Guinard, D., Trifa, V., Karnouskos, S., Spiess, P., & Savio, D. (2010). Interacting with the SOA-Based Internet of Things: Discovery, Query, Selection, and On-Demand Provisioning of Web Services. *IEEE TRANSACTIONS ON SERVICE ORIENTED COMPUTING*, 3(3), 223 - 235.
- Guo, F., & Song, H. (2010). On Designing the Security System of LAN-based Educational Management Information System. *2nd International Conference on e-Business and Information System Security (EBISS)* (pp. 1 - 4). IEEE.
- Gupta, A., Tyagi, S., Panwar, N., Sachdeva, S., & Saxena, U. (2017). NoSQL Databases: Critical Analysis and Comparison. *International Conference on Computing and*

- Communication Technologies for Smart Nation (IC3TSN)* (pp. 293-299). Gurgaon, India: IEEE.
- Gustafsson, J. (2017). Single case studies vs. multiple case studies: A comparative study. 1-15.
- Haq, Z. U., Khan, G. F., & Hussain, T. (2015). A Comprehensive Analysis of XML and JSON Web Technologies. *New Developments in Circuits, Systems, Signal Processing, Communications and Computers*, 102-109.
- He, W., & Xu, L. D. (2014). Integration of Distributed Enterprise Applications: A Survey. *Transactions on Industrial Informatics*, 10(1), 35-42.
- Hevner, A., Brocke, J. v., & Maedche, A. (2019). Roles of Digital Innovation in Design Science Research. *Business & Information Systems Engineering*, 61, 3-8.
- Ho, A. T., & McCall, B. (2016). *Ten Actions to Implement Big Data Initiatives: A Study of 65 Cities*. Washington, D.C: The BM Center for the Business of Government.
- Holzinger, A., Struggl, K. H., & Matjaž, D. (2010). Applying Model-View-Controller (MVC) in Design and Development of Information Systems: An example of smart assistive script breakdown in an e-Business application. *International Conference on e-Business (ICE-B)* (pp. 1 - 6). Athens: IEEE.
- Hua, H., & Herstein, J. (2003). Education Management Information System (EMIS): Integrated Data and Information Systems and Their Implication in Educational Management. *Annual Conference of Comparative and International Education Society*. New Orleans, USA.
- Hui, B., Liaskos, S., & Mylopoulos, J. (2003). Requirements Analysis for Customizable Software Goals-Skills-Preferences Framework. *Proceedings of the 11th IEEE International Conference on Requirements Engineering* (pp. 1-10). IEEE Computer Society.
- Humphrey, W., Snyder, T., & Wills, R. (1991). Software Process Improvement at Hughes Aircraft. *IEEE Software* 8 (4), 11-23.
- Hussey, A., & Carrington, D. (1997). Comparing the MVC and the PAC architectures: a Formal Perspective. *IEE Proceedings - Software Engineering*, 144(4), 224 - 236.
- IBM. (2013 йил 8-10). *Web Services Inspection Language (WSIL)*. From IBM: Developing Web services:  
<http://publib.boulder.ibm.com/infocenter/rsahelp/v7r0m0/index.jsp?topic=/org.eclipse.jst.ws.doc.user/concepts/cwsil.html>
- Ibrahim, R., & Yen, S. Y. (2011). A Formal Model for Data Flow Diagram Rules. *ARPAN Journal of Systems and Software*, 1(2).
- ICT, C. (2021, March 16). *ICT Center*. Retrieved from Tai Solarin University of Education: <https://tasued.edu.ng/ict-center/>
- IMS Global Learning Consortium. (2009). *Adoption of Service Oriented Architecture for Enterprise Systems in Education: Recommended Practices*. White Paper, IMS Global Learning Consortium, Inc.
- Indrayani, E. (2013). Management of Academic Information System (AIS) at Higher Education in the City of Bandung. *13th International Educational Conference* (pp. 628 - 636). Sakarya: Elsevier.
- Iruonagbe, C., Imhonopi, D., & Egbarevba, M. (2015). Higher Education in Nigeria and the Emergence of Private Universities. *International Journal of Education and Research*, 3(2), 49-64.
- Ise, O. A. (2014). Towards a Unified University Information System: Bridging the gap of Data Interoperability. *American Journal of Software Engineering*, 2(2), 26-32.

- Isiaka, R. M., Omidiora, E., Olabiyisi, S. O., & Okediran, O. (2016). An Enhanced Learning Technology System Architecture for Web-Based Instructional Design. *International Journal of Emerging Technologies in Learning (iJET)*, 11(1), 57-61.
- ISO/IEC. (2001). Software Engineering-Product Quality. *ISO/IEC 9126*.
- ITANA. (2012). *The State of SOA in Higher Education*. ITANA SOA Working Group.
- J. Roschelle, J. Kaput, W. Stroup and T. M. Kahn., ((2010).). “Scalable integration of educational software: Exploring , no. 2, the promise of component architectures”. *Journal of Interactive media in education*, pp. 6.
- Jabareen, Y. (2009). Building a Conceptual Framework: Philosophy, Definitions, and Procedure. *International Journal of Qualitative Methods*, 8(4), 49-62.
- Jain, R., Chandrasekaran, A., Elias, G., & Cloutier, R. (2008). Exploring the Impact of Systems Architecture and Systems Requirements on Systems Integration Complexity. *IEEE Systems Journal*, 2(2), 208-223.
- Jakimoski, K. (2016). Challenges of Interoperability and Integration in Education Information Systems. *International Journal of Database and Theory and Application*, 9(2), 33-46.
- Jazayeri, M. (2007). Some Trends in Web Application Development. *Future of Software Engineering (FOSE'07)* (pp. 199 - 213). Minneapolis: IEEE.
- Jiang, L., Xu, L. D., Cai, H., Jiang, Z., Bu, F., & Xu, B. (2014). An IoT-Oriented Data Storage Framework in Cloud Computing Platform. *TRANSACTIONS ON INDUSTRIAL INFORMATICS*, 10(2), 1443 - 1451.
- Jing, M., Li, X., & Bin, Q. (2008). An Education-Oriented Development Framework Research for Business Demand Alteration. *International Symposium on IT in Medicine and Education* (pp. 187 - 192). IEEE.
- Joachim, N., Beimborn, D., & Weitzel, T. (2010). Investigating Adoption Determinants of Service-Oriented Architectures (SOA). *SIGSVC Workshop. 10*. Sprouts: Working Paper on Information Systems.
- Johari, K. (2013). Some Interoperability Issues in the Designing of Web Services: Case Study on Credit Card. *International Journal on Web Service Computing (IJWSC)*, 4(4), 11 - 19.
- Kang, J., & Park, S. (2013). Context-Aware Services Framework Based on Semantic Web Services for Automatic Discovery and Integration of Context. *International Journal of Advancements in Computing Technology(IJACT)*, 5(4), 439-448.
- Karamyshev, A. N. (2017). COMPARATIVE ANALYSIS OF PROCESS-BASED MANAGEMENT METHODOLOGIES. *The Turkish Online Journal of Design, Art and Communication*, 1693-1699.
- Kaur, J. (2011). Service Oriented Architecture Adoption in E-Education System. *International Journal of Computer Science and Communication*, 2(2), 435 - 438.
- Kaya, A., & Dogu, Z. (2013). E-Okul Education Management Information System (e-Okul EMIS): Sanliurfa. *European Journal of Research on Education*, 36 - 41.
- Keh, H. T., & Sun, J. (2018). The Differential Effects of Online Peer Review and Expert Review on Service Evaluations: The Roles of Confidence and Information Convergence. *Journal of Service Research*, 474-489.
- Kelly, B. (2006, February 18). *The e-Framework for Education and Research*. Retrieved from The e-Framework for Education and Research: <http://www.ukoln.ac.uk/qa-focus/documents/briefings/briefing-91/html/index.html>
- Khamparia, A., & Pandey, B. (2013). Review on Semantic Web Service Processes Conference Paper. *Proceedings on International Conference on Computing Science* (pp. 1-10). Jalandhar, Punjab: Elsevier.

- Khazaei, M., & Zalaghi, H. (2016). The Role of Deductive and Inductive Reasoning in Accounting Research and Standard Setting. *Asian Journal of Finance & Accounting*, 8(1), 227-241.
- Ko, A. J. (2019). Individual, Team, Organization, and Market: Four Lenses of Productivity. In *Rethinking Productivity in Software Engineering* (pp. 49-55). Berkeley, CA: Apress.
- Kowalski, G. (2011). Data Structures and Mathematical Algorithms. In *Information Retrieval Architecture and Algorithms* (pp. 27-61). Springer US.
- Kowalski, G. J., & Maybury, M. T. (2002). *Information Storage and Retrieval Systems: Theory and Implementation*. USA: Springer.
- Kraley, V., & Kraleva, R. (2017). Method and Tools for Rapid Application Development. *International Scientific and Practical Conference. 1*, pp. 21-24. Dubai: WORLD SCIENCE.
- Kumar, Y. K., Sujatha, G., & Kumar, G. J. (2013). Resolving Application Development Issues Using SOA. *Publications of Problems & Application in ENGINEERING Research*, 4(1), 148 - 152.
- Kurt D, M. (2001). Education Management Information System: What is It and Why Do We Not Have More of It. *International Journal of Technologies for the Advancement of Knowledge and Learning*, 8 - 12.
- Laaziri, M., K. B., Khouliji, S., Larbi, K. M., & Yammami, A. E. (2019). A comparative study of laravel and symfony PHP frameworks. *International Journal of Electrical and Computer Engineering (IJECE)*, 9(1), 704-710.
- Laftsidis, A. (2000). *Enterprise Application Integration*. IBM Sweden.
- Laguna, M. A., Lopez, O., & Crespo, a. Y. (2014). Reuse, Standardization, and Transformation of. *International Conference on Software Reuse*, 330 - 332.
- Lal, N., Shiwani, S., & Qamar, S. (2016). Information Retrieval System and challenges with Dataspace. *International Journal of Computer Applications*, 147(8), 23 - 28.
- Lawler, J. P., Benedict, V., Hortense, H.-B., & Anthony, J. (2009). Critical Success Factors in the Planning of a Service-Oriented Architecture (SOA) Strategy for Educators and Managers. *Information Systems Education Journal*, 7(94).
- Leal, J. P., & Queiros, R. (2010). Elearning Frameworks: A Survey. *4th International Technology, Education and Development Conference*, (pp. 1345-1354). Valencia, Spain.
- Leung, H. (2001). Organizational Factors for Successful Management of Software Development. *Journal of Computer Information Systems* 42 (2), 26-37.
- Li, J., Xiong, Y., Liu, X., & Zhang, L. (2014). How Does Web Services API Evolution Affect Clients. *20th International Conference on Web Services (ICWS)* (pp. 1-8). Santa Clara, USA: IEEE.
- Linden, J. B., Onarheim, B., & Christensen, B. T. (2010). Design requirements, epistemic uncertainty and solution development strategies in software design. *Special Issues Studying Professional Software Design*, 31(6), 567-589.
- Liu, J. Y.-C., Chen, V. J., Chan, C.-L., & Lie, T. (2008). The impact of software process standardization on software flexibility and project management performance: Control theory perspective. *Information and Software Technologies* 50 (08), 889-896.
- Liu, S., & Yang, Z. (2008). Digital Education Service Chain: Model and Architecture. *Computer Science and Software Engineering International Conference. 4*, pp. 959 - 962. Whan, China: IEEE.
- Lohe, J., & Legner, C. (2010). SOA Adoption in Business Networks: Do Service-Oriented Architectures really advance Inter-Organizational Integration? *Electronic Market: The International Journal of Networked Business*, 20(3-4), 181 - 196.

- Lucca, G. A., & Fasolino, A. R. (2006). Testing Web-Based Applications: The State of the Art and Future Trends. *Information and Software Technology*, 48(12), 1172 - 1186.
- MacLenna, E., & Belle, J.-P. V. (2014). Factor Affecting the Organizational Adoption of Service-Oriented Architecture (SOA). *Information Systems and e-Business Management*, 12(1), 71 - 100.
- Maguire, M., & Delahunt, B. (2017). Doing a Thematic Analysis: A Practical, Step-by-Step Guide for Learning and Teaching Scholars. *All Ireland Journal of Teaching and Learning in Higher Education (AISHE-J)*, 8(3), 3351-33514.
- Mahmoud, C. B., Azaiez, I., Bettahar, F., & Abel, M.-H. (2016). A Learning Semantic Web Service for Generating Learning Paths. *International Journal on Semantic Web and Information Systems*, 12, 23-43.
- Maier, R., Hädrich, T., & Peinl, R. (2009). Integration Services. In *Enterprise Knowledge Infrastructures* (pp. 1 - 90). Springer Berlin Heidelberg.
- Maleshkova, M., Pedrinaci, C., & Domingue, J. (2010). Investigating Web APIs on the World Wide Web. *8th European Conference on Web Services (ECOWS)* (pp. 1-8). Ayia Napa, Cyprus: IEEE.
- Marczyk, G., DeMatteo, D., & Festinger, D. (2017). *Essentials of Research Design and Methodology*. USA: John Wiley & Sons, Inc.
- Marinela, M. (2012). SOA Adoption in Higher Education: a practical guide to service oriented virtual learning environment. *Procedia - Social and Behavioral Sciences (Elsevier)*, 31, 218 – 223.
- Markeset, T., & U.Kumar. (2003). Design and Development of Product Support and Maintenance Concepts for Industrial Systems. *Journal of Quality in Maintenance Engineering* 9 (4), 376-392.
- Mary-LuzSanchez-Gordon, Amescua, A., V.O'Connor, R., & XabierLarrucea. (2017). A standard-based framework to integrate software work in small settings. *Journal of Computer Standards & Interfaces*, 54(3), 162-175.
- Mendes, E. (2014). Web Development Versus Software Development. In *Practitioners's Knowledge Representation* (pp. 13 - 25). Springer-Verlag.
- Mikreyyohannes, F., & Omer, A. M. (2013). Data Exchange Using Web Services: The Cases of Ethiopian Revenue and Customs Authority and Transport Authority. *HiLCoE Journal of Computer Science and Technology*, 75-80.
- MINEDUC. (2017). *An Architecture for the Integrated Education Management Information System*. MINEDUC.
- Mitchell, M. L., & Jolley, J. M. (2010). *Research Design Explained*. USA: Wadsworth, Cengage Learning.
- Mohammad, R., & Goknur, A. A. (2010). Enterprise Application Integration (EAI), Service Oriented Architectures (SOA) and their relevance to e-supply chain formation. *African Journal of Business Management*, 4(13), 2604-2614.
- Mohd Hasan, S., & Abdulmonem, A. K. (2009). Service Oriented Architecture in Education Sector. *International Journal of Computer Science and Network Security*, 9(5), 301 - 308.
- Monika, A., Uma, K., & Dinesh, V. (2010). Challenges in Web Information Retrieval. *Innovations in Computing Sciences and Software Engineering*, 141 - 146.
- Muthanna, S., Konotogiannis, & Stacey, K. P. (2000). A maintainability model for industrial software systems using design level metrics. In *Seventh Working Conference on Reverse Engineering*, (pp. 248-256).
- N, S., & L, a. C. (November, 2000). Architecture-Driven Embedded Systems Adaptation for Supporting Vocabulary Evolution. *Proceedings of International Symposium on Principles of Software Evolution*, 144-153.

- Nayak, A., Poriya, A., & Poojary, D. (2013). Type of NOSQL Databases and its Comparison with Relational Databases. *International Journal of Applied Information Systems (IJ AIS)*, 5(4), 16 - 19.
- NBTE. (2019, October 3). *National Board for Technical Education*. Retrieved October 2019, from National Board for Technical Education: <https://net.nbte.gov.ng/>
- NCCE. (2019, October 5). *List of Colleges of Education in Nigeria*. Retrieved October 2019, from Welcome To National Commission for Colleges of Education: <http://www.ncceonline.edu.ng/colleges.php>
- Nicolás, L., Rubby, C., & Jorge, V. (2007). Challenges in Creating Environments for SOA Learning. *International Workshop on Systems Development in SOA Environments* (p. 9). Minneapolis, USA: IEEE Computer Society.
- NUC. (2019, January 14). *About Us*. Retrieved from National University Commission: <http://www.nuc.edu.ng/about-us/>
- NUC. (2019, October 4). *National University Commission*. Retrieved October 2019, from National University Commission: <http://www.nuc.edu.ng>
- Offermann, P., Levina, O., Schönherr, M., & Bub, U. (2009). Outline of a Design Science Research Process. *Proceedings of the 4th International Conference on Design Science Research in Information Systems and Technology* (pp. 1 - 11). Malvern, USA: ACM.
- OKI. (2021, June 23). *About the OSIDs*. Retrieved from About the OSIDs: <http://www.mit.edu/afs.new/athena/project/okidev/okiproject/apps/okichange/web/osids.html>
- Olaleye, F. O., & Oyewole, B. K. (2016). Quality Assurance in Nigerian University Education: The Role of the National University Commission (NUC) as a Regulatory Body. *International Journal of Academic Research in Business and Social Sciences*, 6(2), 160-169.
- Onwuegbuzie, A. J. (2012). Qualitative Analysis Techniques for the Review of the Literature. *The Qualitative Report, Volume 17*(Article 56), pp. 1-28.
- Onwuegbuzie, A. J., Leech, N. L., & Collins, K. M. (2012). Qualitative Analysis Techniques for the Review of the Literature. *The Qualitative Report, Volume 17*(Article 56), pp. 1-28.
- OpenUSS. (2021, June 23). *Open Source Software for Universities and Faculties (Open Source University Support System)*. Retrieved from Open Source Software for Universities and Faculties (Open Source University Support System): <http://openuss.sourceforge.net/openuss/index.html>
- Oracle. (2014 йил 08-10). *Discovering Web Services*. From Oracle® Web Services Manager Administrator's Guide: [http://docs.oracle.com/cd/E11036\\_01/doc.1013/e10299/wsil.htm](http://docs.oracle.com/cd/E11036_01/doc.1013/e10299/wsil.htm)
- Panetto, H., & Cecil, J. (2013). Information Systems for Enterprise Integration, Interoperability and Networking: Theory and Applications. *Enterprise Information Systems*, 7(1), 1-6.
- Panhwar, A. H., Ansari, S., & Shah, A. A. (2017). Post-positivism: An Effective Paradigm for Social and Educational Research. *International Research Journal of Art & Humanities*, 45(45), 253-260.
- Paolucci, M., Kawamura, T., Payne, T. R., & Syncara, K. (2002). Importing the Semantic Web in UUDI. In *Web Services, E-Business, and the Semantic Web* (pp. 225-236). Springer.
- Papazoglou, M. P., & Dubray, J.-j. (2004). *A Survey of Web Service Technologies*. Departmental Technical Report, Tilburg University, Netherlands, Information Engineering and Computer Science.



- Parker, A., Bragin, E., Brent, S., Pritchard, B., Smith, a. A., & Trevanion, S. (2010). Using Caching and Optimization Techniques to Improve Performance of the Ensembl Website. *BMC Bioinformatics*, 11(239).
- Patil, N. V., Kshirsagar, M. C., & Jaypal, P. C. (2014). Enterprise Application Integration using Service Oriented Architecture with Generic Pattern. *International Journal of Current Engineering and Technology*, 4(5), 3540-3545.
- Péči, M., & Važan, P. (2014). Choosing the Right Systems Integration. *Research Papers Faculty of Materials Science and Technology*, 22(35), 23-30.
- Pedrinaci, C., Domingue, J., & Sheth, A. P. (2011). Semantic Web Services. In *Handbook of Semantic Web Technologies* (pp. 977 - 1035). Springer-Verlag Berlin Heidelberg.
- Peffer, K., Tuunanen, T., & Niehaves, B. (2018). Design science research genres: introduction to the special issue on exemplars and criteria for applicable design science research. *European Journal of Information Systems*, 27(2), 129-139.
- Peffer, K., Tuunanen, T., Rothenberger, M. A., & Chatterjee, S. (2007). A Design Science Research Methodology for Information Systems Research. *Journal of Management Information Systems*, 24(3), 44 - 77.
- Peng, D., Cao, L., & Xu, W. (2011). Using JSON for Data Exchanging in Web Service Applications. *Journal of Computational Information Systems*, 7(16), 5883 - 5890.
- Perry, D. E., & Wolf, A. L. (1992). Foundations for the Study of Software Architecture. *Software Engineering Notes*, 40-52.
- Ploscar, A. (2012). XML-RPC vs. SOAP vs. REST web services in Java – uniform using WSWrapper. *INTERNATIONAL JOURNAL OF COMPUTERS*, 6(4), 215 - 223.
- Pokorny, J. (2013). NoSQL Databases: A Step to Database Scalability in Web Environment. *International Journal of Web Information Systems*, 9(1), 69 - 82.
- Polkinghorne, M., & Arnold, A. (2014, February 10). *A Six Step Guide to Using Recursive Abstraction Applied to the Qualitative Analysis of Interview Data*. Bournemouth University.
- Qi, A., Wang, Y., & Shen, C. (2016). Application of Courseware Based on Information Retrieval Technology. *International Journal of Emerging Technologies in Learning*, 11(03), 32 - 36.
- Rexwhite, E. T., Doreen, O. Y., & Akpovoka, E. O. (2013). The Use Of Databases For Information Storage And Retrieval In Selected Banks In Delta State, Nigeria. *INTERNATIONAL JOURNAL OF SCIENTIFIC & TECHNOLOGY RESEARCH*, 2(3), 11 - 24.
- Ridder, H.-G. (2017). The Theory Contribution of Case Study Research Designs. *Business Research*, 10, 281–305.
- Runeson, P., & Höst, M. (2009). Guidelines for Conducting and Reporting Case Study Research in Software Engineering. *Empirical Software Engineering*, 14, 131–164.
- Ryan, S., & O'Connor, R. V. (2009). Development of a Team Measure for Tacit Knowledge in Software Development Teams. *Journal of Systems and Software*, 82(2), 229-240.
- Sagiroglu, S., & Sinanc, D. (2013). Big Data: A Review. *International Conference on Collaboration Technologies and Systems (CTS)* (pp. 42 - 47). San Diego, CA, USA: IEEE.
- Sahin, K., & Gumusay, M. (2008). Service Oriented Architecture (SOA) Based Web Services for Geographic Information Systems. *The International Archives of the Photogrammetry, Remote Sensing and Spatial Information Sciences*, 37(B2), 625 - 629.
- Sajjad, A. B., & Awais, A. (2010). Challenges in Education Management Information System in Developing Countries.

- Sasmito, G. W., & Wiyono, S. (2017). Implementation of Rapid Application Implementation of Rapid Application System of Harapan Bersama Polytechnic. *International Journal of Computer Trends and Technology (IJCTT)*, 50(1), 11-13.
- Sayed, A., Bahaa, A., & Elfangary, L. (2016). A Proposed Interoperable Architecture for Educational Software Systems. *International Journal of Engineering Sciences & Research Technology*, 5(12), 941-947.
- Schwabe, D., Rossi, G., Esmeraldo, L., & Lyardet, F. (2001). Web Design Frameworks: An Approach to Improve Reuse in Web Applications. In *Web Engineering* (pp. 335 - 352). Berlin: Springer Berlin Heidelberg.
- Seref, B., & Tanriover, a. O. (May 2016). Software Code Maintainability: A Literature Review. *International Journal of Software Engineering & Applications (IJSEA)*.
- Shetty, S. D., & Vadivel, D. S. (2009). Interoperability Issues seen in Web Services. *International Journal of Computer Science and Network Security*, 9(8), 160 - 168.
- Sonnenberg, C., & Brocke, J. v. (2012). Evaluations in the Science of the Artificial – Reconsidering the Build-Evaluate Pattern in Design Science Research. *Proceedings of 7th International Conference of Design Science Research in Information Systems (DESRIST 2012)* (pp. 381 - 397). Las Vegas, USA: Springer.
- Soto Setzke, D., Kavılı, M. C., & Böhm, M. (2020). ON THE USE OF QUALITATIVE COMPARATIVE ANALYSIS IN INFORMATION SYSTEMS RESEARCH – A CRITICAL REVIEW. *Twenty-Eighth European Conference on Information Systems (ECIS2020)*, , (pp. 1-19). Marrakesh, Morocco.
- Staab, S., Scheglmann, S., Leinberger, M., & Gottron, T. (2014). Programming the Semantic Web. In *The Semantic Web: Trends and Challenges* (pp. 1 - 5). Crete, Greece: Springer International Publishing.
- Stephen, J. Y., Blue, C. L., Irene, Y.-L. C., Ben, J. W., & April, C. C. (2005). CONTEXT AWARE SERVICE ORIENTED ARCHITECTURE FOR WEB BASED. *IASTED International Conference - WEB-BASED EDUCATION*, (pp. 261 - 266). Drindelwald, Switzerland.
- Stoica, F., & Cacovean, L. F. (2010). Interoperability Issues in Accessing Databases Through Web Services. *Recent Advances in Neural Networks, Fuzzy Systems & Evolutionary Computing*, 279 - 284.
- Stojanov, Z. (2016). Inductive Approach in Software Process Assessment. *International Conference on Applied Internet and Information Technologies*, (pp. 1-15).
- Sukma, A., & Saragih, H. (2017). Inductive Reasoning in Marketing Research to Respond The Future Market Challenges. *3rd Parahyanga International Accounting and Business Conference*, (pp. 514-520).
- Sullivan, G. M., & Artino, A. R. (2013). Analyzing and Interpreting Data From Likert-Type Scales. *Journal of Medical Education*, 5(4), 541–542.
- Sumaray, A., & Makki, S. K. (2012). A Comparison of Data Serialization Formats for Optimal Efficiency on a Mobile Platform. *6th International Conference on Ubiquitous Information Management and Communication*. New York, USA: ACM .
- Surbhi, & Chawla, R. (2013). Object Serialization Formats and Techniques a Review. *Global Journal of Computer Science and Technology*, 13(6).
- Tamene, E. H. (2016). THEORIZING CONCEPTUAL FRAMEWORK. *Asian Journal of Educational Research*, 4(2), 50-56.
- Tariq, R. S., & Abrar, H. A. (2012). Challenges and Future of Enterprise Application Integration. *International Journal of Computer Applications*, 42(7), 42-45.
- Teufel, B. (1991). *Organization of Programming Languages*. Springer-Verlag.
- Thirunarayan, K., & Immaneni, T. (2009). Integrated Retrieval from Web of Documents and Data. *Advances in Data Management*, 223, 25-48.

- Tutz, G. (2020). Hierarchical Models for the Analysis of Likert Scales in Regression and Item Response Analysis. *International Statistical Review*, 89(1), 18–35.
- UNESCO. (2013, July 31). Implementation of Standard-setting Instruments. *192nd UNESCO Executive Board* (pp. 1-53). Paris: UNESCO. Retrieved from Unesco: <http://unesdoc.unesco.org/images/0022/002223/222315e.pdf#page=9>
- UNESCO. (2018). *Re-Orienting Education Management Information Systems (EMIS) Towards Inclusive And Equitable Quality Education And Lifelong Learning, Unesco Emis Policy Paper 05*.  
URL:<https://millenniumedu.files.wordpress.com/2018/04/unesco-emis-policy-paper>. Retrieved August 2020, from UNESCO EMIS Policy Paper 05: <https://millenniumedu.files.wordpress.com/2018/04/unesco-emis-policy-paper-2018.pdf>
- UNISA. (2014, 10 13). *POLICY ON RESEARCH ETHICS*. Retrieved from UNiversity of South Africa: [http://www.unisa.ac.za/contents/colleges/col\\_grad\\_studies/docs/Policy\\_research\\_ethics\\_21September2007.pdf](http://www.unisa.ac.za/contents/colleges/col_grad_studies/docs/Policy_research_ethics_21September2007.pdf)
- Verborgh, R., Steiner, T., Deursen, D. V., Roo, J. D., Walle, R. V., & Vallés, J. G. (2013). Capturing the Functionality of Web Services with Functional Descriptions. *Multimedia Tools and Applications*, 64(2), 365-387.
- Villanueva, C. C. (2003). *Education Management Information System (EMIS) and the Formulation of Education for All (EFA) Plan of Action - 2002 - 2015*. UNESCO.
- Vliet, H. v. (2007). *Software Engineering: Principles and Practice*. Wiley.
- Vujasinovic, M., & Marjanovic, Z. (2006). Data Level Enterprise Applications Integration. *International Conference on Business Process Management*. 3812, pp. 390-395. Springer, Berlin, Heidelberg.
- Vukmanovic, D., & Kalpic, D. (2012). Key Practices for SOA Adoption. *5th WSEAS Congress on Applied Computing Conference* (pp. 20 - 25). Wisconsin, USA: World Scientific and Engineering Academy and Society (WSEAS).
- Wako, T. N. (2003). *Education Management Information System (EMIS): An Overview*. Harare, Zimbabwe: NESIS/UNESCO.
- Walker, E. (2012). “Primer on K-20 Education Interoperability Standards”,. *Publication of the Software Information Industry Association*.
- Wang Yanfeng, B. X. (2009). The Structure of EMIF and its model for data exchange and message processing. *First International Workshop on Education Technology and Computer Science* (pp. 170-173). IEEE.
- Wang, G. (2011). Improving Data Transmission in Web Application via the Translation between XML and JSON. *Third International Conference on Communication and Mobile Computing* (pp. 182-185). Qingdao, China: IEEE.
- Wang, J., & Shi, T. (2012). Design of Graduate Education Management Information System based on C/S and B/S Mised Mode. *Advances in Information Technology and Industry Applications*, 557 - 563.
- Wanga, H. H., Gibbinsb, N., Paynec, T. R., & Redavidd, D. (2012). A Formal Model of the Semantic Web Service Ontology. *Information Systems*, 37(1), 33 – 60.
- Widdowson, M. (2011). Case Study Research Methodology. *International Journal of Transactional Analysis Research*, 2(1), 25-34.
- Wilde, N., Bagui, S., Coffey, J., El-Sheikh, E., Reichherzer, T., White, L., . . . Terry, C. (2013). Interoperable Systems and Software Evolution: Issues and Approaches. In *Digital Enterprise Design and Management 2013* (pp. 45 - 56). Springer.

- Wilkinson, M. D., Vandervalk, B., & McCarthy, L. (2011). The Semantic Automated Discovery and Integration (SADI) Web service Design-Pattern, API and Reference Implementation. *Journal of Biomedical Semantics*, 2(8), 1 - 23.
- Woolf, B. P. (2009). Evaluation. In M. Kaufmann, *Building Intelligent Interactive Tutors* (pp. 183-220).
- Wu, J., Ping, L., Ge, X., Y. W., & Fu, J. (2010). Cloud Storage as the Infrastructure of Cloud Computing. *International Conference on Intelligent Computing and Cognitive Informatics* (pp. 380 - 383). IEEE.
- Xu, L. D. (2011). Enterprise Systems: State-of-the-Art and Future Trends. *IEEE TRANSACTIONS ON INDUSTRIAL INFORMATICS*, 7(4), 630 - 640.
- Y.B.Lu, Xiang, C., Wang, B., & Wang, X. (2011). What Affects Information Systems Development Team Performance? An Exploratory Study From Combined Socio-Technical Theory And Coordination Theory. *Journal of Computers in Human Behavior*, 811-822.
- Yang, S., & Joy, M. (2008). SOA Services in Higher Education. *Proceedings of the 7th International Conference on Education and Educational Technology*, (pp. 145 - 150). Vernice, Italy.
- Yu, H. R. (2015). Design and implementation of web based on Laravel framework. *International Conference on Computer Science and Electronic Technology (ICCSET 2014)* (pp. 301-304). Atlantis Press.
- Yunyun, M., & Huakun, X. (2010). Research on Multi-tier EMIS System Based on Web Services. *International Conference on e-Business and E-Government* (pp. 5496 - 5499). Guangzhou, China: IEEE.
- Zeng, W., Zhao, Y., Ou, K., & Song, W. (2009). Research on Cloud Storage Architecture and Key Technologies. *2nd International Conference on Interaction Sciences: Information Technology, Culture and Human (ICIS '09)*. Seoul, Korea: ACM.

## APPENDIX 1



### Interview Schedules

Research Project: A Service-Oriented Technical Framework for the Development of Integrated Education Management Information Systems

Researcher: Mr Adenubi, Ademola Olaide

Supervisor: Dr Mtsweni, Jabu

School of Computing

College of Science, Engineering and Technology

University of South Africa

The purpose of this interview is to obtain data and information on the use of EMIS by tertiary education institution, identify the method of data integration across EMIS of different platforms and languages, discuss the SOA approach as integration technique and the requirements for design of SOA-based technical framework for EMIS integration. Please answer the following questions in detail. All the information provided in this interview will be treated as confidential and will be used for research purposes only.

#### Use of EMIS

- What are EMIS?
- What are EMIS used for in the University?
- How will you describe the forms of EMIS that is used in tertiary education system?
- Does the development of EMIS as an integrated system assist data exchange?
- Is there any challenge with the integration of EMIS to achieve data exchange?
- What are the challenges with the integration of EMIS?

#### Integrated EMIS Design and Development

- How can EMIS be developed as an integrated System?
- What technology approach is used for integrated EMIS development?
- What are the approaches and techniques that are currently being used to achieve data exchange in EMIS?
- Do you observe any standard design approach for the development of integrated EMIS?

- How will you describe the current design approach for integrated EMIS development process?

#### Use of SOA Approach for Integrated EMIS Development

- Describe your understanding of the application of SOA to EMIS application development and data exchange?
- Do you consider SOA as effective approach to EMIS application data exchange across platforms?
- How can the functional component of EMIS be exposed as services? How can these services relate with data storage and retrieval across different platform?
- What technology can be used to support the use of SOA for the cross-platform data exchange?
- How can the SOA technology be enhanced to seamlessly integrate EMIS for data exchange and interoperability?
- To achieve data interoperability, what requirements are necessary for consideration in using SOA for EMIS integration
- How can these requirements be evaluated to ensure effective integration of EMIS for interoperability?

THANK YOU FOR PARTICIPATING IN THIS STUDY!

## APPENDIX 2

Respondent Number: \_\_\_\_\_



### Letter of informed consent to be signed by all respondents Research Project: A Service-Oriented Technical Framework for the Development of Integrated Education Management Information Systems

Researcher: Mr Adenubi, Ademola Olaide  
Supervisor: Dr Mtsweni, Jabu  
School of Computing  
College of Science, Engineering and Technology  
University of South Africa

Dear Prospective participant

I am conducting research for my PhD studies to investigate, design, develop and evaluate a Service-Oriented Technical Framework that seamlessly integrate Education Management Information Systems (EMIS) that are developed with heterogeneous programming languages and platforms. This is necessary to ensure interoperability of data for effective and efficient EMIS. Your participation will be in the form of semi-structured interview to discuss on the subject area.

Data collected during the interview will remain confidential, but it can only be disposed after five years because of the university rules. After five years all materials used in this interview will be destroyed. The interview will take few hours to complete.

Anonymity of the participants will be strictly protected and all data collected from the participants will be treated with full confidentiality. No personal details of the participants will be revealed in the report of the results. Please note that only the researcher and the supervisors will have access to the data collected at any point in time during the course of the research.

This interview is expected to last, not more than 3 hours. During the interview, written notes will be taken and electronic device will be used to record the details of the discussion. However, your participation in the interview is voluntary and you may choose to decline participation or opt out, at any point, during the interview or refuse to answer any question you considered sensitive, for whatever reason.

Should you agree to participate in this study, please fill in and sign the section below.

I \_\_\_\_\_ (full names of participant) hereby confirm that I understand the contents of this document and the nature of the research project, and I consent to participating in the research project. I understand that I

am at liberty to withdraw from the project at any time, should I so desire. I hereby give permission that my responses may be used in the above research project, provided that none of my personal details will be made public in the published research report.

Signature: \_\_\_\_\_ Date: \_\_\_\_\_

Place: \_\_\_\_\_



### APPENDIX 3

#### Thematic Analysis of Responses to Interview Questions

QUESTIONS	R111	R112	R121	R122	R211	R221	R222	R311	R321	R411	R421	R511	R512	R521	R522	R523	Codes
What is EMIS?	EMIS is an Education Management System that is used by universities to collect, process and manage information within the system for effective decision making	EMIS is a management information system that is used to manage all the education institutions	EMIS is a management information system that is used to manage all the various or large data/information that is generated in the education system	EMIS is a platform that helps to manage all the various campus sets of information and data in the education in order to be able to make access to information and decision making easier within the system itself	EMIS is basically, an Educational Management Information System that helps to capture an institution's information or data, process it and make good informed decision based on the data. It also stores and retrieves information within the university system. It could be structure	EMIS is a management information system that helps to make the entire process of student registration from the point of entry to the point of exit seamless. Within EMIS are interconnected modules communicating and sharing information with each other in order to ensure smooth running	EMIS could be described as an Educational Management Information System that helps to oversee record keeping within an education institution	EMIS is a management information system that allows for seamless communication and interaction between all the diverse modules or segment within an educational institution. For instance, the Admission module in the EMIS solution helps to collect prospective student's	EMIS is an Educational Management Information System that helps to oversee data exchange and information between academic units within an institution	EMIS is an acronym for Educational Management Information System that provides the necessary information needed to support all the activities within an institution. Which could be related to management, planning and decision-making process. EMIS is a Management	EMIS is an Educational Management Information System. It helps in data collection including demographic information of all the stakeholders within an institution, student attendance, course information, result processing and management of financial data within an institution	EMIS is an integrated human and computer-based process providing all the information needed to support all activities within an educational institution. This could include management, planning and decision-making. EMIS is a Management Support Service and, it	EMIS can be described as an Educational Management Information System. It is for generating, sorting, processing and sharing information within an institution, which could include: student information, course administration, result processing and financial	EMIS is a web-based solution that is designed to assist University administrators to plan and administer an education system seamlessly. The university uses it to generate report and analyze data to monitor the students' performance in academic program mes that are offered by the	EMIS is a management information system that serve as a tool for administering the various data generated within an institution	EMIS is an Educational Management Information System that is developed as a web-based solution that is accessible by various categories of users in the university for purpose of performing their user-defined roles in the university.	Purpose and Usage Benefits and functionalities Processing capacity Forms of data for processing Information and communication structure Type of Development platform

					ed or semi-structure	of the whole process and seamless data exchange in the system		data, which is later used to process the student profile into the university.		ment Support Service and, it supports different users of education statistics		supports different users within the education system.	management.	institution				
How are EMIS used in the University?	EMIS is a software tool used to automate processes within the university and it is fast becoming a standard platform to meet the National Universities Commission's requirement by providing the electronic data needed for periodic accreditation of academic programmes in the	We have been able to use EMIS to reduce to the barest minimum the bad behaviour of students all over our campuses, because we have their full information and details at our fingertips.	EMIS helps us to be able to manage information across all the various segments of the institution, in Academic for example, we can manage data for accreditation easily	We use EMIS to effectively and efficiently manage and run the day to day activities of the institution which would otherwise seem impossible or herculean	EMIS is used to capture, process and share student information seamlessly. For example, we have a system that serves as a point of entry that allows student to express their intention to get admitted into the university. This system allows them to further confirm their interest by filling	EMIS is used as a tool to strengthen smooth running of the day to day activities within the university	EMIS is utilized as an apparatus to meeting the requirements of the National Universities Commission by providing electronic information data as a prerequisite to the periodic accreditation of scholastic projects.	EMIS helps to effectively and efficiently analyze the large amount of data generated within an institution in order to facilitate decision-making process. For instance, the use of the EMIS help to provide a summary of school fees payments by the University Bursary department using the shared data from	EMIS is used to automate payments and registrations within an institution. The Admission modules in the EMIS solution for instance, is used to collect prospective student's data, which is later used to process the student profile into the university	EMIS is utilized as a tool to meeting the NUC requirements from each university by providing real-time digital statistics of their institution. It is also used to manage every activity that is referred by management to the EMIS team	EMIS is used for various purpose within the university system, one of such is to capture Alumni's data for strong Alumni network and development	We use EMIS to capture student information, which is then used to process their academic results which is put forward for considerations at the University Academic Board.	EMIS is utilized as a system by the NUC to call for digital records from universities as a condition to the periodic accreditation of scholastic tasks.	EMIS is used to generate, store, process, access and retrieve stored data of students and staff of the university in real time.	EMIS is used for various purposes, which include the processing and generation of revenue reports from the back-end payment data.	We use EMIS to generate Data for several use and purposes, such as Admission overview, payment statistics, result and student performance analysis, final year pass list.	Internal process control Internal Data Exchange with functional modules Data exchange with External sources Consequential benefits	

	universit y				a form which captures their JAMB score, Post-UTME scores, and other necessary details. The details is then used to process, share and monitor all their activities, relating to academic , payment history, result processing etc within the institutio n			the EMIS. It is also equally used to establish and maintain alumni relations									
How will you describe the forms of EMIS that is used in tertiary education system?	EMIS could either be custom made or off the shelf. Because of the cost and peculiarities of our institutio	We use a custom made EMIS that is developed by us for our use.	EMIS could take different forms but I don't believe in off the shelf application, as it mostly does not	We use a locally developed EMIS based on our needs, in doing this, we look at what is going on in the	There are 2 forms of EMIS. It is either Stand alone or Integrated. In our own institution for instance,	EMIS are either in stand-alone or integrated form but we have each EMIS program working on	The Form of EMIS we use in our university is custom made stand-alone EMIS with each having its	We have a web portal that handles the student information promptly, both academic and	EMIS are either stand-alone or integrated, our institution for instance makes use of some forms of	There are basically 2 forms of EMIS: stand alone or integrated. However, there are other forms of	We use several forms of stand-alone EMIS, with each having its own data source from different	We use an integrated EMIS that helps us in centralizing data from several sectors within the institutio	The EMIS used in our institution is a web-based, custom-developed, scalable and	We use a custom developed EMIS that helps in the seamless data exchange and integratio	We use an integrated EMIS that is custom built in order to effectively meet our local requirements as an	Forms of EMIS used in the university are stand-alone or Integrated which could either be custom	Special need and peculiarities of institutions  Mode of development and acquisition

	n, we used the custom developed EMIS to run our system		fit into our own context, as such. Our EMIS is built by us based on our need and capacity	field of EMIS and then see to what extent what we can adopt that would be useful to our EMIS.	we use few stand-alone EMIS that are developed by us to suit our present needs.	different standalone applications for use as EMIS to handle different challenges	own separate data	financial records, which are what we have. Our solution is called University Management Information System (UMIS), which is one of the products developed by DewCis Solutions in the Open Baraza's open-source project	web-based EMIS with a framework of integrated functional modules that addresses key academic and administrative tasks.	that are not usually captured in the integrated EMIS. For instance, we use the open-source koha EMIS for library management and Moodle for learning management in our institution.		n. This has brought remarkable success in managing several units of the University, for Statistics and control.	integrated EMIS with integrated functional modules such as Admission, Registration, Payments, Result Processing and Users Profile Management.	n of module extension whenever the needs arise	institution. It is usually the best practices to build a locally developed EMIS that suits your institution.	made off the shelf. For us, we develop a web portal that integrates new modules for our use	Type of platform Specialty in the development approach Forms of connections to backend database Basis and mode of classification Benefits of integrated module
Does the development of	We have separate stand-	The development of	The development of	Integrating the various	Having an integrate	Integrating our various	Development of EMIS as	We use an integrate	Integrating the various	We currently run a	The structure I met here	The university uses a	We have various EMIS	Having an integrate	Yes, to a large extent,	We run an integrate	Solution design to

EMIS as an integrated system assist data exchange ?	alone with each performing specific functions within the university. Integrating them all together would be hard to achieve.	EMIS as an integrated system would assist data exchange but we could not implement due to the structure of EMIS we inherited, and we have the responsibility to manage it till a convenient time to re-develop	EMIS as an integrated system does not assist seamless data exchange, because the integrated EMIS development increases the complexities of EMIS design and over-centralize the back-end database	forms of EMIS we have would make the design structure of the EMIS too complicated	d EMIS against several form of EMIS within an institution would really help make data exchange seamless but most of our EMIS programmer don't have the proper technical know-how for such development process	EMIS would not really facilitate seamless data exchange, which is why we use several EMIS with each having its own database.	an integrated system would not really assist seamless data exchange across all EMIS within the system. This is because of possible need for a complex layer of data integration and communication channel that is required to develop and deploy integrated solutions	d EMIS that helps to facilitate data exchange seamless among all the functional modules within the system.	EMIS helps to capture, process and share information easily across all the various segment in the university	separate stand-alone EMIS structure, integrating them all together might help achieve seamless data exchange across all but we have to keep maintaining the one we have now as developing an integrated EMIS would require a lot of time and effort, which we currently don't have.	is that of several EMIS within the system, really don't have the time and training to make the switch but having an integrated EMIS would help facilitate easy data exchange across all the various EMIS which is one of the key challenges we are facing.	locally developed integrate d EMIS solution to manage all the academic process in the institution, this makes it easy to access, retrieve and share information and data seamlessly with all the integrate d modules within the system	with each performing its specific functions communicating and sharing information with each other seamlessly, this is only possible through Integrated EMIS. it has helped made running the day to day activities of the various sectors easier and also facilitate effective decision-making process within the university.	d EMIS with functional modules helps to make the process of data and information exchange easy and seamless across all functional modules	Integrated EMIS helps to ease the data exchange process across all the functional modules within our institution.	d EMIS that helps to facilitate the exchange of data between the various EMIS and functional modules within the university	support separate but several functions. Implications of integration on data exchange. Limitations with integration. Complexity in design structure. Technical know-how of developers. Database connections design. Benefits of integrated system.
Is there any challenge with the integration of EMIS to	There are many challenges with integration of EMIS	Challenges of integrated EMIS are in multiple folds and	Yes, there would always be challenges with trying to	We do not have challenges of integration because all	Yes, there are usually challenges with the integration	Yes, there are challenges.	Yes, especially with difference in data format for each	Yes,	There is always a challenge of seamless data exchange	There are indeed challenges with EMIS integration to	There are challenges	Yes, there are various challenges	Yes, there are challenges	There are numerous challenges	Yes	Yes, challenges exist	Means of data exchange. Structure of EMIS

achieve data exchange ?	which from time to time require manual means to resolve exchange of records	sometimes require manual process to resolve exchange of data	integrate all the various EMIS within an institution especially when management requests data that requires cross platform data processing.	applications run on its own. But when the need be, we manually copy and process data across different EMIS using the Microsoft Excel platform	n of EMIS		of the various EMIS		in an integrated EMIS	achieve data exchange							in institution Cross-platform data processing Difference in data format
What are the challenges with the integration of EMIS?	There are numerous challenges that comes with integrating the various EMIS within an institution, one of such is the differences in the technology platform for each of the various EMIS, which affect level of integration	The external request of information from the National University Commission, which is the regulatory body within the education system, would always pose a challenge of integration especially in their	The constant change of information requirements which in most cases usually lead to re-definition in the structure of the EMIS to capture the new development is a key challenge related to Integrated EMIS	Difference in data format required for each of the various integrated EMIS is a major challenge	One of the challenges an integrated EMIS would always have is the external request of information from bodies like government regulatory agency in the education system which in most cases warrants for re-	The differences in the various technology development platform of EMIS is one of the greatest challenges having an integrated EMIS would have to deal with, which would limit its capacity to interoperate	Changing requirements of the university system and difference in the data format of the EMIS is a major challenge to contend with when trying to exchange data	One of the challenges of integrated EMIS is the differences in the underlying technologies of the off-the-shelf EMIS and the customized developed module that is integrated to it is a major challenge towards achieving integration	The difference in data format between the various forms of EMIS to be integrated would always pose a challenge due to the underlying technologies of the off-the-shelf EMIS and the customized developed module	There are quite a lot of them, one of such challenges is related to the low-technical know-how of the EMIS programs within an institution and the changing information requirement of the institution which would in most cases	The various EMIS usually have different data formats, this is a major challenge towards achieving integration across all functional modules	Low technical know-how and competencies of the EMIS programmers within an institution would always pose a challenge towards achieving integration. When there is need for an open-source EMIS to be integrated with an existing EMIS, if	The difference in data format between the Core module and the various functional module extension is one of the challenges towards achieving seamless data exchange in an Integrated EMIS.	Changing information requirement of the institution is one of the challenges towards achieving EMIS integration. Sometimes, a module is designed and developed based on some specifications and after a while, the specification is	Changing information requirement of the institution always pose a challenge towards achieving integration across the multiple EMIS platform as in most cases leads to the redefinition of the EMIS structure to capture the new	Technology and platform difference. Challenges and Implications with integration Periodic and changing request for data Changing design and development structure	

	n that can be done	quest for regular updated education data relating to student and staff records, Academic programmes record etc.			development in the design structure of EMIS	with each other.		n of the multiple modules	that are integrated	warrant a redefinition of the EMIS structure in order to capture the new development		the EMIS programmers do not have proper technical skill or up to date programming knowledge, integration in such cases would be very difficult and sometimes impossible.	format and standard between the institutional EMIS and the external government agency that is requesting education data.	changed by the university policy, especially when there is a change of administration.	development.	Design as integrate modules  Requirement for technical know-how	
What technologies and techniques are being used for the development of integrated EMIS?	We keep abreast of what is ongoing in the field of EMIS and then see to what extent we can bring in useful technologies. We also make use of the open source and modify the source code to suit our	We make use of object-oriented language for instance PHP(OOP). This makes it easier for us to reuse our blocks of codes across different EMIS that share same logic.	We employ the use of object-oriented language using the NetBeans development platform to ease the development process.	Standalone was the technique used and also an open source code for re-coding.	One of the techniques we adopted is the API approach, which was used to access and retrieve data from the back-end database	I only use front-end technologies like HTML, CSS, JavaScript and Angular for developing the front end interface of our EMIS.	We use object-oriented coding languages like PHP and ease our development process with the framework like Bootstrap	Here, we use open source technologies like PHP for logic and programming and then use MySQL for the backend database. We develop our EMIS as a web based application and integrate easily to an acquired	We rely on the existing technologies of the off-the-shelf EMIS that is acquired by the university. We only develop module extension using the PHP/MYSQL open source technologies	Each EMIS is developed as a standalone application that can import and export data in CSV format	Our development technique is to use a development platform like the NetBeans to develop each EMIS as a standalone application that can export data in format that other	We write our codes with object-oriented approach using the Model-View-Controller methods to make it easy for EMIS to be developed as an integrated system that can easily be scaled with new functional module	We used the combination of the object-oriented approach with the Model-View-Controller (MVC) as our choice of coding style in the development process of our integrated EMIS following the tiered	We use different technologies at the front and back ends in the development of our integrated EMIS. I use the CSS, JavaScript and Angular on a Bootstrap framework to develop the front-end.	We adopted the tiered programming logic for the development process of our integrated EMIS and use the open source technologies of the PHP as scripting language to handle the logic layer; we use the	We use the combination of the php and mysql technologies to develop the EMIS as an integrated web solution.	anxiety and plan for development approach to development as use of technology for integration benefits of using technology platform

	own development interface. We can also redesign the whole process. We make use of open source software that allows for regular updates						EMIS based on existing framework			EMIS can accept as input		programming architecture design		MySQL to handle the database and then rely on the front-end technologies that is embedded in the Bootstrap to handle the page presentation and loading.		development platform	
What factors do you consider for the development of integrated EMIS that can exchange data seamlessly?	The first thing we consider is the requirement analysis for the new EMIS with less focus on conditions for integration	Requirement analysis is one major factor to be considered in the development process of EMIS	The changing requests from various departments of the university and how best to harmonize them	Once the requirement analysis is conducted, we model a design and then develop and deploy the EMIS solution	We start first by defining the requirement analysis for the EMIS, and deploy we have employed software programmers who then design, develop the EMIS solution	Requirement analysis is the starting point for the development process of EMIS	We factor in our mode of operation within the university and how best the EMIS can add value.	We first consider the requirement analysis for the module or EMIS with consideration on the data elements that are needed to be shared with the main EMIS	In our own case, we first carry out a requirement analysis which is presented as 'project specifications', it is then reviewed and transformed to 'Software codes' by some external expert and then reviewed and deployed by internal	In our case for example, we begin our development process by reviewing the requirements for the new EMIS, especially the functions and tasks that it will handle, and the data it will require from our back-end database	We first conduct a requirement analysis considering the data elements that would be shared with the main EMIS	Once we conclude on the analysis of the functionalities of the EMIS functional module, we proceed to the software development process with the appropriate programmers	The factors we consider are first the Requirement Analysis and the Coding development process	For us, the first thing we do when we receive a call for new solution to be plugged into the EMIS is to call a meeting of EMIS developers to review the functionalities of the new module and examine its point of connection with the	We first conduct a requirement analysis then proceed to code development	In our case, after the requirement analysis have been conducted, transformed to software codes, the codes are then subjected to review by head of the development team in order to strengthen and standardize the coding style.	Requirement gathering Condition and approach for integration Development activities Implication of development approach



									EMIS developers					main EMIS that we have.			
What are the approaches and techniques that are currently being used to achieve data exchange in EMIS	The technique is to keep separate databases for each EMIS and then use import/export file approach to move data between several EMIS. For example, payment information about students of the institution is downloaded in Comma Separated Values (CSV) format from the EMIS on Students' Fees Payment System and then uploaded through a file import	We adopted the stand-alone EMIS approach so as to avoid the technical complexities involved in shared database of an integrated EMIS	We used the file export and import technique for exchanging data across our several EMIS	Our EMIS are of several stand-alone systems. We have developed interfaces to upload and download files and then use the manual process to manipulate the data to extract necessary information that is required.	For us, we have different EMIS that handles separate task and connects with its own database.	The approach used to achieve data exchange in EMIS was to adopt the Stand-alone form of EMIS. To exchange data, therefore, we use to download data and manually process it. Sometimes, we write separate scripts to query data from multiple data sources.	We import and export data from different stand-alone EMIS and process it as appropriate with another data processing software.	Achieving seamless data exchange across all the functional module for us was a major factor for adopting the Integrated EMIS development process for our institution.	We used the Shared Back-end Database to achieve seamless integration and exchange of data across all the functional modules within the university system	EMIS deals with large amounts of data, as such, for us to avoid the complexities that usually comes with sharing and integrating all these data, we adopted the Stand-alone EMIS Approach	We adopted the Stand-alone EMIS approach with each having its own separate data.	For us to achieve seamless data exchange across all the functional modules we adopted the Integrated EMIS approach	We wanted to ensure easy administration and flow of data within our institution, that's why we adopted the integrated EMIS approach that helps facilitate the process.	We use a combination of approach to achieve data exchange within our integrated EMIS, they include the File Import and Export technique and the API connection technique	One of such technical approach to achieve seamless data exchange in EMIS is the Shared Back-end Database, this helps to handle the logic layer of an integrated EMIS using Structured Query Language (SQL)	We adopted the use of Application Programming Interface (API) connection to achieve seamless data exchange across the various EMIS platform in the institution.	Database architecture approaches Technique for data exchange Development approach Technical complexity with integration approach Implication of integration approach

	interface, into the Students' Result Processing System which requires the students' fees payment status as condition for processing individual student's results.																
Do you observe any standard design approach for integrated EMIS development process?	We don't observe any standard design for our EMIS development	No, we don't observe any	There is no design standard that is being observed for EMIS development process	No standard design is adopted except what we are able to make from the requirement analysis when new task comes up	We don't follow any standard design for our EMIS development	We don't observe any form of design standard approach, but we conceptualize a design idea around each development task.	It has to do with what the lead programmer thinks	There is no generally accepted design standard for the development of EMIS but we key into the existing framework of the off-the-shelf EMIS that is adopted by the university	No, but our design standard evolves with the development process within our institution	There is design standard that is observed in the development of integrated EMIS. But due to the dynamism involved in EMIS development process, the issue of design standard is majorly based on the thinking	No, we don't observe any standard design approach for the development of our EMIS	Yes, we follow a design standard for the development process of our integrated EMIS, but it changes as the development progresses and as new requirement for a functional module in the integrate	. The design standard of EMIS development process usually evolves with the development process within the institution.	The design standard for the development of integrated EMIS are mostly based on the knowledge of the lead programmer who coordinates the EMIS development process	Yes, because we use custom made integrated EMIS, there is a form of design standard used in the development process of our integrated EMIS	Yes, we do have a form of design standard approach for the development of our integrated EMIS which is mostly described by the lead EMIS programmer	Alternative approach to using standard design approach  Conviction on the use of design standard  Dynamism of the development standard  Limitations to the use of design standard

										or specification of the lead EMIS programmer		d EMIS is being developed					
How will you describe the current design approach for integrated EMIS development process?	I am not aware of any design framework being used for EMIS development in Nigeria	We don't use or follow any design approach to EMIS	Not aware of any such design approach to EMIS development process	We don't follow any design approach for EMIS development process	I really cannot give any feedback on the question. I don't think there is any EMIS development design framework currently in existence	There is no design framework for EMIS development	Am not sure such design framework exist for EMIS development process.	I am not aware of any design framework for EMIS development. However, we liaise with our external consultants on some guidelines for developing some EMIS module that align with existing solution	We align with the framework that captures the development of our outsourced EMIS	I can't give any response to this question. I don't think any of such design framework exist for EMIS development	We don't have any design framework for our EMIS development process	The design approach captures the flow of the integrated EMIS and also provides the basis for functional modules to share and exchange data with support for scalability to allow for the integration of new functional modules	We adopted a custom design approach and follow that with all our development as a guide.	We follow our design pattern that shows the flow of data and connection ends of each module.	We use the design standard of the team lead.	Our design standard is provided for in the general flow of the integrated EMIS	Awareness of design approach Knowledge and practice requirement Implication for the use of standard design approach
What are the limitations and challenges of the EMIS design framework?	None to appraise	I cannot give feedback on this question, as we don't have any design framework for EMIS	I am not aware of EMIS design framework	I am not conversant with the technical framework of the EMIS	None to my knowledge	I cannot really say the challenges in the technical framework, I only make use of the system	I don't really have any response on this, I am not aware of any design framework for EMIS	I can't really say	No limitation	No idea	I can't figure out any	One of the major limitations and challenges with EMIS design framework is around the complexities in the	The application of the design framework is limited to need and requirements of the institution and may not	Regular changes to the structure of the EMIS framework	The framework is evolving and require extensive study to map out a framework that standardise the development	The requirements for new functional modules are expanding and requires changes to the framework. The	Knowledge limitation Challenges with use of design framework

											<p>structure and administration of the integrated EMIS as additional functional modules are integrated with increasing potential for data redundancy and inconsistencies in the underlying data structure</p>	<p>represent the standard for other institutions. There is need for a platform to cross-check the facts.</p>		<p>ent process of the integrated EMIS</p>	<p>framework should standardize the structure of EMIS that will ordinarily respond to new requirements.</p>	<p>Cause of limited use of design framework</p>
--	--	--	--	--	--	--	--	--	--	--	---------------------------------------------------------------------------------------------------------------------------------------------------------------------------------------------------------------	--------------------------------------------------------------------------------------------------------------	--	-------------------------------------------	-------------------------------------------------------------------------------------------------------------	-------------------------------------------------

Searching and Identifying Themes

Questions	Search for Themes	Review Themes	Define Themes
What is EMIS?	<p>C1.1: Purpose and Usage</p> <p>C1.2: Benefits and functionalities</p> <p>C1.3: Processing capacity</p> <p>C1.4: Forms of data for processing</p> <p>C1.5: Information and communication structure</p> <p>C1.6: Type of Development platform</p>	<p>T1: Significance of EMIS</p> <p>T1.1: Purpose and Usage of EMIS</p> <p>C1.1: Purpose and Usage</p> <p>T1.1: Functions and Benefits of EMIS</p> <p>C1.2: Benefits and functionalities</p> <p>C2.4: Consequential benefits</p> <p>C3.7: Benefits</p> <p>T2: Structure and Architecture of EMIS</p> <p>T2.1: Structure of EMIS in Nigerian Universities</p> <p>C5.2: Structure of EMIS in institution</p> <p>C4.1: Solution design to support separate but several functions</p> <p>C2.2: Internal Data Exchange with functional modules</p> <p>C2.3: Data exchange with External sources</p> <p>T2.2: Challenges with EMIS Design Structure</p> <p>C4.4: Complexity in design structure</p> <p>C6.4: Changing design and development structure</p> <p>T3: Process of EMIS Development</p> <p>T3.1: Plans and Procedure for Development</p> <p>C7.1: anxiety and plan for development</p> <p>C8.1: Requirement gathering</p> <p>C8.3: Development activities</p> <p>T3.2: Approaches to Development Process</p> <p>C7.2: approach to development</p> <p>C9.3: Development approach</p> <p>T3.3: Considerations for Development</p> <p>C3.1: Special need and peculiarities of institutions</p> <p>C3.4: Specialty in the development approach</p> <p>C4.5: Technical know-how of developers</p> <p>T3.4: Modes and Approaches to Development</p> <p>C3.2: Mode of development and acquisition</p> <p>T3.5: Implications of Development Approach</p> <p>C8.4: Implication of development approach</p> <p>T4: Data Processing and Exchange in EMIS</p> <p>T4.1: Forms and Structure of Data</p> <p>C1.4: Forms of data for processing</p> <p>C1.5: Information and communication structure</p> <p>C5.4: Difference in data format</p> <p>T4.2: Data Processing and Control</p> <p>C1.3: Processing capacity</p> <p>C2.1: Internal process control</p>	<p>T1 – Signifiant Value</p> <p>T2 – Design Structure</p> <p>T3 – Development Process</p> <p>T4 – Data Exchange</p> <p>T5 – Development Platform</p> <p>T6 – Integration Approach</p> <p>T7 – Design Standard</p>
How are EMIS used in the University?	<p>C2.1: Internal process control</p> <p>C2.2: Internal Data Exchange with functional modules</p> <p>C2.3: Data exchange with External sources</p> <p>C2.4: Consequential benefits</p>		
How will you describe the forms of EMIS that is used in tertiary education system?	<p>C3.1: Special need and peculiarities of institutions</p> <p>C3.2: Mode of development and acquisition</p> <p>C3.3: Type of platform</p> <p>C3.4: Specialty in the development approach</p> <p>C3.5: Forms of connections to backend database</p> <p>C3.6: Basis and mode of classification</p> <p>C3.7: Benefits</p>		
Does the development of EMIS as an integrated system assist data exchange?	<p>C4.1: Solution design to support separate but several functions</p> <p>C4.2: Implication of integration on data exchange</p> <p>C4.3: Limitations with integration</p> <p>C4.4: Complexity in design structure</p> <p>C4.5: Technical know-how of developers</p> <p>C4.6: Database connections design</p> <p>C4.7: Benefits of integrate system</p>		

Is there any challenge with the integration of EMIS to achieve data exchange?	<p>C5.1: Means of data exchange</p> <p>C5.2: Structure of EMIS in institution</p> <p>C5.3: Cross-platform data processing</p> <p>C5.4: Difference in data format</p>	<p>C5.3: Cross-platform data processing</p> <p>T4.3: Database Connections</p> <p>C3.5: Forms of connections to backend database</p> <p>C9.1: Database architecture approaches</p> <p>C4.6: Database connections design</p> <p>T4.4: Data Exchange Approach</p> <p>C4.2: Implication of integration on data exchange</p> <p>C5.1: Means of data exchange</p> <p>C9.2: Technique for data exchange</p>	
What are the challenges with the integration of EMIS?	<p>C6.1: Technology and platform difference.</p> <p>C6.2: Challenges and Implications with integration</p> <p>C6.3: Periodic and changing request for data</p> <p>C6.4: Changing design and development structure</p> <p>C6.5: Design as integrate modules</p> <p>C6.6: Requirement for technical know-how</p>	<p>T5: Platforms for EMIS Development</p> <p>T5.1: Types of Developments</p> <p>C3.6: Basis and mode of classification</p> <p>C3.3: Type of platform</p> <p>C1.6: Type of Development platform</p> <p>C7.5: development platform</p> <p>T5.2: Benefits and Limitations of Development Platform</p> <p>C7.4: benefits of using technology platform</p> <p>C6.1: Technology and platform difference.</p>	
What technologies and techniques are being used for the development of integrated EMIS?	<p>C7.1: anxiety and plan for development</p> <p>C7.2: approach to development</p> <p>C7.3: use of technology for integration</p> <p>C7.4: benefits of using technology platform</p> <p>C7.5: development platform</p>	<p>T6: Approaches to EMIS Integrations</p> <p>T6.1: Achieving EMIS Integration</p> <p>C6.5: Design as integrated modules</p> <p>C7.3: use of technology for integration</p> <p>C8.2: Condition and approach for integration</p> <p>C9.5: Implication of integration approach</p> <p>T6.2: EMIS Integration Challenges</p> <p>C6.2: Challenges and Implications with integration</p> <p>C6.3: Periodic and changing request for data</p> <p>C6.6: Requirement for technical know-how</p> <p>C9.4: Technical complexity with integration approach</p>	
What factors do you consider for the development of integrated EMIS that can exchange data seamlessly?	<p>C8.1: Requirement gathering</p> <p>C8.2: Condition and approach for integration</p> <p>C8.3: Development activities</p> <p>C8.4: Implication of development approach</p>	<p>T6.3: Benefits and Limitations of Integrated EMIS Design</p> <p>C4.3: Limitations with integration</p> <p>C4.7: Benefits of integrate system</p>	
What are the approaches and techniques that are currently being used to achieve data exchange in EMIS?	<p>C9.1: Database architecture approaches</p> <p>C9.2: Technique for data exchange</p> <p>C9.3: Development approach</p> <p>C9.4: Technical complexity with integration approach</p> <p>C9.5: Implication of integration approach</p>	<p>T7: Design Standards for EMIS Development</p> <p>T7.1: Awareness on Standard Design Framework</p> <p>C11.1: Awareness of design approach</p> <p>C10.2: Conviction on the use of design standard</p> <p>T7.2: Between Practice and Standard Framework</p> <p>C10.1: Alternative approach to using standard design approach</p>	

Do you observe any standard design approach for integrated EMIS development process?	<p>C10.1: Alternative approach to using standard design approach</p> <p>C10.2: Conviction on the use of design standard</p> <p>C10.3: Dynamism of the development standard</p> <p>C10.4: Limitations to the use of design standard</p>	<p>C11.3: Implication for the use of standard design approach</p> <p>T7.3: Challenges and Limitations of Standard Framework</p> <p>C10.3: Dynamism of the development standard</p> <p>C10.4: Limitations to the use of design standard</p> <p>C11.2: Knowledge and practice requirement</p> <p>C12.1: Knowledge limitation</p> <p>C12.2: Challenges with use of design framework</p> <p>C12.3: Cause of limited use of design framework</p>	
How will you describe the current design approach for integrated EMIS development process?	<p>C11.1: Awareness of design approach</p> <p>C11.2: Knowledge and practice requirement</p> <p>C11.3: Implication for the use of standard design approach</p>		
What are the limitations and challenges of the EMIS design framework?	<p>C12.1: Knowledge limitation</p> <p>C12.2: Challenges with use of design framework</p> <p>C12.3: Cause of limited use of design framework</p>		

## APPENDIX 4

### Conceptual Framework Analysis

Themes	Data Mapping: mapping and categorisation of the themes	Concept Identification review of the categorised themes to inductively identify phenomena that can be modelled as concepts with its descriptive attributes	Concept Integration grouping and integrating related concepts to identify broader concept that is more descriptive to capture the greater idea of the related concepts	Technical Review review of each of the concepts and attributes to raise technical arguments to represents the idea in each block of the conceptual framework
Principle 1: Identify the Information Needs of the Education Institution	Adaptability Requirement  Articulating and adapting to the specific information needs	Requirements + needs and peculiarities + design complexity + design implications + EMIS structure + Technical Know-how	Requirements Analysis + recognising the needs and peculiarities of schools + understanding design approach and its complexity + planning and assessing implications of adopted approach + capacity building for EMIS developer + approach is limited by technical know-how	Requirement Analysis + Education Information Structure
Principle 2: Set-up and Organise the EMIS Development Team	Maintainability Requirement	Structural Organisation + planning + development team + EMIS stakeholders + technical know-how		
Principle 3: Enhance the Technical Know-how of the EMIS Developers	Structural arrangement for supporting and maintaining the development			
Principle 9: Define Endpoints and Re-Usable Methods for Data Exchange	Scalability Requirement	Design Structure + plugins extension + re-usable methods	Design Structure + standard design framework + update design with changes in requirements + scalable and integrated modular design + limited by technical know-how	Design Structure + Service-Oriented Design + Functional Modules + Connectivity and Exchange + Multi-tenants cloud design
Principle 10: Make Provision for New Information Needs and Plugins	Structured to enhance extension	Integration + endpoint connections + data exchange channel  Requirements + information needs + flexibility + update		
Principle 4: Chose the Design Architecture for EMIS Implementation	Standardisation Requirement	Design Structure + implementation standard + design architecture		



Principle 5: Adopt a Design Standard	Use of standard technologies and techniques	Development Approach + programming style + standard development  Exchange System + data processing & format + exchange channels + connectivity and exchange		
Principle 8: Adopt a Standard Programming Logic for EMIS Development			Development Approach + planning the approach to development activity + development platform that fit the requirements + update changes in design and requirements + consider integration technology in development process	Development Approach + Implementation Logic + Development Activities + Development Platform + Cloud Approach + Integration Approach
Principle 6: Choose the Standard Data Format for Information Exchange			Integration and Exchange Mechanism + mechanism for data processing and control + defining channels for data exchange + considerations for the technical complexity + data format and exchange across modules	Integration and Exchange Mechanism + Exchange Mechanism + Integration Technologies + Data Format and Exchange + Data Exchange Channels
Principle 7: Ensure EMIS Gain Access to Shared Database	Connectivity Requirement  Connecting multiple data sources	Data Connections + data storage + data request + data exchange		
Principle 11: Collect and Store Data from Multiple Data Sources				
Principle 12: Present Data in Format that Support Decision-Making	Accessibility Requirement  Access and presentation of data	Data Retrieval System + data processing + data format + data exchange + data request	Data Storage System + data structures and architecture + data processing and connections to storage system + database connections and request processing + data processing and exchange	Data Storage System + Database System + Connections & Storage + Requests Processing

## APPENDIX 5



### Expert Review Questionnaire

Research Project: A Service-Oriented Technical Framework for the Development of  
Integrated Education Management Information Systems

Researcher: Mr Adenubi, Ademola Olaide

Supervisor: Dr Mtsweni, Jabu

School of Computing

College of Science, Engineering and Technology

University of South Africa

The purpose of this close-ended questionnaire is to obtain expert review feedback for the evaluation of the proposed technical framework for the development of integrated EMIS. Please answer the following questions by ticking the appropriate scale (SD – Strongly Disagree; D – Disagree; U – Undecided; Agree; SA – Strongly Agree). Information provided in this questionnaire will be treated as confidential and will be used for research purposes only.

Questions		Responses				
		SD	D	U	A	SA
		1	2	3	4	5
Justification						
Q1	Do you agree that integrated EMIS is required to optimise processes in education institutions				4	6
Q2	Is technical framework required for the development of integrated EMIS that can optimised education processes?		1	2	3	4
Q3	Is the proposed technical framework adequate for the development of integrated EMIS?				4	6
Adaptability						
Q4	Do you agree that a framework for the development of integrated EMIS should		1	1	4	4

	be adaptable to the specific information requirements of the education system?					
Q5	Does the modular functionality of the Central Information System in the Education Information System component of the technical framework make the integrated EMIS adaptable to the education system?			1	4	5
Maintainability						
Q6	Is the ease of maintenance a requirement in the design of technical framework for the development of the integrated EMIS?			1	4	5
Q7	Does the use of simple and familiar technologies, like REST API with JSON, in the framework demonstration ease the maintenance of the integrated EMIS development?		1	1	3	5
Standardisation						
Q8	Do you agree that the education system requires standard framework to guide the development of integrated EMIS that can seamlessly exchange data?		1	2	3	4
Q9	Is the use SOA approach to the design concept of the proposed framework standardise the development of integrated EMIS?			2	3	5
Q10	Does the use of tiered architecture that separates the integrated EMIS development into layers of programming logics standardise the demonstration of the proposed framework?		2	1	2	5
Scalability						
Q11	Is the ability to scale in respond to new information needs a requirement for framework for the development of integrated EMIS?			1	6	3

Q12	Does the EIS component of the proposed framework with interfaces to connect with other functional modules allows for scaling of the integrated EMIS with new information requirements?			2	4	4
Connectivity						
Q13	Is connectivity between the EMIS application layer and the shared database to access and exchange data a requirement for the framework for integrated EMIS development?			3	5	2
Q14	Is the use of database management system like the MySQL adequate to manage access and retrieval of data in an integrated EMIS development framework?		2	2	4	2
Q15	Do you agree that the combination of the cache with the RESTful API that handles data requests is a useful technique of delivering efficient connectivity and data exchange in the development of integrated EMIS?		1	2	6	1
Accessibility						
Q16	Is accessibility to data for presentation a requirement in the design of framework for the development of integrated EMIS?		1		4	5
Q17	Does the provision of library of APIs that retrieve data from multiple sources to provide data analytics ensure data accessibility in the integrated EMIS development?			2	3	5

# LANGUAGE EDITING CERTIFICATE

## TAI SOLARIN UNIVERSITY OF EDUCATION

### DEPARTMENT OF ENGLISH STUDIES

*Ijagun, Ijebu-Ode, Ogun State.*

Our Ref: \_\_\_\_\_



Our Ref: \_\_\_\_\_

July 15, 2021

#### CERTIFICATE OF ENGLISH LANGUAGE EDITING

This letter certifies that the Ph.D. research thesis indicated below was edited by me to ensure clarity and grammatical felicity.

Title: A service-oriented technical framework for the development of integrated education management information system.

Author: Adenubi, Ademola Olaide

The editing process involved the checking of logicity, cohesion and linguistic appropriateness, especially in the Syntax of the thesis. This was performed by a team of professionals, led by me, in the Department of English Studies, Tai Solarin University of Education, Ijagun, Nigeria. The intent of the author's message was not altered in any way during the editing process.

The quality of editing is hereby guaranteed, with the assumption that suggested corrections have been effected without any further alteration not made known to the editors.

Thank You.

Bandele Adeboye Sogbesan Ph.D.  
Professor of Discourse Analysis

## THESIS SUMMARY

This research study investigated, designed, demonstrated and evaluated a service-oriented technical framework for the development of integrated EMIS using the design science research methodology. The study contributed to knowledge with the proposition of a technical framework that simplifies and standardizes the development of integrated EMIS that seamlessly exchange data.

The technical framework is designed from the identification of technical concepts from the thematic analysis of findings from semi-structured interview of sixteen (16) participants from five (5) purposively selected universities in Nigeria. The technical components of the framework are: (1) Education Information Structure (EIS) that provides adaptable secured Central Information System (CIS) for handling the specific information requirements of different education systems; (2) Service-Oriented Design layer that handles integration of functional modules to connect with the EIS with service interfaces; (3) Implementation Logic layer that recognizes the development platform and the flexibility of the programming logic to scale with new information requirements; (4) Data Exchange Mechanism that provides a layer of standard data serialization format using Java Script Object Notation (JSON) to exchange data through the RESTful API services; (5) Database System layer that handles data storage and requests from services.

Thus, the framework provides a technical standard for the development of integrated EMIS that connects different education tasks as functional modules that can be integrated together. It was, however, demonstrated on a web-based platform using the Laravel development platform that offer framework for rapid application development. The demonstration considered a single case study approach, and the evaluation was based on expert review and comparative analysis using the identified requirements from the research findings as benchmark. These requirements for the design and development of EMIS are Adaptability, Maintainability, Standardization, Scalability, Connectivity and Accessibility.

In essence, the technical framework is appropriate for the development of integrated EMIS that uses simplified technologies and techniques for achieving EMIS integration. While the framework addressed the integrated EMIS development that achieve seamless data exchange

and scalability using the service endpoint extensions, the issues of optimizing the framework for enhanced security and performance are open to further research.